

LAMONA

at the heart of the kitchen

Built-in Single Pyrolytic Oven

LAM3708
LAM3709



Instructions and Installation

Register 
my appliance

www.howdens.com/appliance-registration

ISSUE v3. 030522



Free 3 year guarantee

Call now¹

Within the UK:

0333 010 0009

Within Republic of Ireland:

01525 5752

Alternatively, visit www.howdens.com/appliance-registration

LAMONA

**3 year guarantee available.
Register your appliance within 90 days²**

By registering your appliance and creating an account, we will keep you up to date with the latest product information and notify you immediately of any important product updates

¹Lines are open Monday to Friday 9am to 5pm. Calls will be charged at your local rate and may be recorded and monitored for training and quality purposes.

²So that in the event of an important product update, or recall, we can contact you.

Register 
my appliance

Welcome

Dear Customer,





Congratulations on your choice of oven.

The user manual will help you use your product quickly and safely.

- Please read this user manual before installing and using the oven.
- Always follow the safety instructions.
- Keep this user manual within easy reach for future reference.
- Register your appliance to access a digital copy of your user manual for future reference.
- Please read any other documents supplied with the product.

Explanation of symbols





Throughout this manual the following symbols are used.

	Hazard that may result in death or injury. NOTICE Hazard may result in material damage to the product or its environment.
	Hazard that may result in burns due to contact with hot surfaces.
	Important information or useful usage tips.
	Read the user manual.

Contents

1. Safety instructions	5	4. First use	21
Purpose of usage	5	First time setting	21
Child, vulnerable person and pet safety	6	First cleaning	22
Electrical safety	6	5. How to operate the oven	23
Transportation safety	7	General information on oven usage	23
Installation safety	8	Operation of the oven control unit	23
Safety of use	8	Bread function	29
Temperature warnings	8	Settings	31
Accessory use	9	6. General information about cooking	36
Cooking safety	9	General warnings about cooking in the oven	36
Maintenance and cleaning safety	10	Pastries and oven food	36
High temperature self-cleaning (Pyrolysis)	10	Meat, Fish and Poultry	40
General warnings about cooking in the oven	11	Grill	41
2. Environmental instructions	12	7. Maintenance and care	42
Waste regulation	12	General cleaning information	42
Package information	12	Cleaning the accessories	44
Recommendations for energy saving	12	Cleaning the control panel	44
3. Your product	13	Cleaning the inside of the oven (cooking area)	44
Product introduction	13	Pyrolytic self-cleaning	45
Product control panel introduction and usage	14	Cleaning the oven door	48
Oven control	14	Removing the inner glass of the oven door	49
Oven operating functions	15	Cleaning the oven lamp	51
Product accessories	17	8. Troubleshooting	52
Use of product accessories	18	9. Installation	54
Technical specifications	20	10. Your guarantee	60

1. Safety instructions

- This section contains safety instructions that will help prevent any risks of personal injuries or material damage.
- If the product is transferred to another person or used second hand, the operating manual, product labels, other relevant documents and accessories should be delivered with the product.
- Our company shall not be held responsible for any damage that may occur as a result of failure to comply with these instructions.
- Failure to comply with these instructions shall render any warranty void.
-  Always have the installation and repair work performed by the manufacturer, the authorized service or a person specified by the importer.
-  Use genuine spare parts and accessories only.
-  Do not attempt to repair or replace any part of the product unless it is clearly specified in the operating manual.
-  Do not perform technical modifications on the product.

Purpose of usage

- This product is designed for home use. It is not suitable for commercial use.
- Do not use the product in gardens, balconies or other outdoor environments. The appliance is intended to be used in household and staff kitchen areas in shops, offices and other working environments.
- **WARNING:** This product should be used for cooking purposes only. It should not be used for different purposes, such as heating the room.
- The oven can be used to defrost, bake, fry and grill food.
- This product; should not be used for heating, plate heating, hanging towels or clothes on the handle for drying.

Child, vulnerable person and pet safety

- This product can be used by children 8 years of age and older, and people who are underdeveloped in physical, sensory or mental skills, or lack of experience and knowledge, as long as they are supervised or trained about the safe use and hazards of the product.
- Children should not play with the product. Cleaning and user maintenance should not be performed by children unless there is someone overseeing them.
- This product should not be used by people with limited physical, sensory or mental capacity (including children), unless they are kept under supervision or receive the necessary instructions.
- Children should be supervised to ensure that they do not play with the product.
- Electrical products are dangerous for children and pets. Children and pets must not play with, climb on, or enter the product.
- Do not put objects that children may reach on the product.
- **WARNING:** During use, the accessible surfaces of the product are hot. Keep children away from the product.
- Keep the packaging materials out of the reach of children. There is a hazard of injury and suffocation.
- When the door is open, do not put any heavy objects on it or allow children to sit on it. You may cause the oven to tip over or damage the door hinges.
- For the safety of children, disconnect the power cable and make the product inoperable before disposing of the product.

Electrical safety

- Wire the product into a grounded outlet protected by a fuse that matches the current ratings indicated on the type label. Have the grounding installation made by a qualified electrician. Do not use the product without grounding in accordance with local / national regulations. The electrical connection of the product should be in an easily accessible place (where it will not be affected by the flame of the stove). If this is not possible, there should be a mechanism (fuse, switch, etc.) on the electrical installation to which the product is connected, in compliance with the electrical regulations and separating all poles from the network.
- The product must not be wired into the outlet during installation, repair, and transportation.

- Do not wire the product into an outlet that is loose, has come out of its socket, is broken, dirty, oily, with risk of water contact (for example, water that may leak from the counter).
- Never touch the electrical connection with wet hands! To remove appliance, do not pull the cord.
- Make sure that the product is securely wired into the outlet to avoid arcing.
- Wire the product into an outlet that meets the voltage and frequency values specified on the type label.
- Do not jam the power cord under and behind the product. Do not put a heavy object on the power cord. The power cord should not be bent, crushed, and come into contact with any heat source.
- While the oven is operating, its back surface also gets hot. Power cords must not touch the back surface, connections may be damaged.
- Do not jam the electric cables into the oven door and pass them over hot surfaces. You may cause the oven to short circuit and catch fire as a result of the cable melting.
- Use original cable only. Do not use cut or damaged cables or extension leads.
- If the power cord is damaged, it must be replaced by a manufacturer, an authorized service or a person to be specified by the importer company in order to prevent possible dangers.
- **WARNING:** Before replacing the oven lamp, be sure to disconnect the product from the mains supply to avoid the risk of electric shock. Disconnect the product or turn off the fuse from the fuse box.

Transportation safety

- Disconnect the product from the mains before transporting the product.
- The product is heavy, carry the product with at least two people.
- Do not use the door and / or handle to transport or move the product.
- Do not put other items on the product and carry the product upright.
- When you need to transport the product, wrap it with bubble wrap packaging material or thick cardboard and tape it tightly. Secure the product tightly with tape to prevent the removable or moving parts of the product and the product from damage.
- Check the overall appearance of the product for any damage that may have occurred during transportation.

Installation safety

- Before the product is installed, check the product for any damage. If the product is damaged, do not install it.
- Do not install the product near heat sources (radiators, stoves, etc.).
- Keep all ventilation ducts open around the product.
- To prevent overheating, the product should not be installed behind decorative doors.

Safety of use

- Make sure that the product is turned off after each use.
- If you do not use the product for a long time, disconnect it or turn off the fuse from the fuse box.
- Do not operate defective or damaged product. If any, disconnect the electricity / gas connections of the product and call the authorized service.
- Do not use the product with the front door glass removed or broken.
- Do not climb on the product to reach anything or for any other reason.
- Do not use the product in situations that may affect your judgment, such as drug intake and / or alcohol use.
- Flammable objects kept in the cooking area may catch fire. Never store flammable objects in the cooking area.
- The oven handle is not a towel dryer. When using the product, do not hang towels, gloves or similar textiles.
- The hinges of the product door move and tighten when opening and closing the door. When opening / closing the door, do not hold the part with the hinges.

Temperature warnings

- **WARNING:** While the product is operating, exposed parts will be hot. Do not touch the product and heating elements. Children under the age of 8 should not be brought close to the product without an adult.
 - Do not place flammable / explosive materials near the product, as the edges will be hot while it is operating.
 - As steam may be exhaled, keep away while opening the oven door. The steam may burn your hand, face and / or eyes.
 - The product may be hot during use. Do not touch the hot compartments, the interior parts of the oven, the heating elements, etc.
 - When placing food in the hot oven, removing the food, etc. always use heat resistant oven gloves.
-

Accessory use

- It is important that the wire grill and tray are placed properly on the wire shelves. For detailed information, refer to the section “Usage of accessories”.
- Accessories can damage the door glass when closing the product door. Always push the accessories to the end of the cooking area.
- Use only the meat probe recommended for this oven.

Cooking safety

- Be careful when using alcohol in your food. Alcohol evaporates at high temperatures and may catch fire when exposed to hot surfaces, causing a fire.
- Food waste, oil, etc. in the cooking area may catch fire. Before cooking, remove such coarse dirt.
- Food Poisoning Hazard: Do not keep food in the oven for more than an hour before and after cooking. Otherwise it may cause food poisoning or diseases.
- Do not heat closed tin cans and glass jars. Built-up pressure may cause the jar to burst.
- Place the greaseproof paper in a cookware or on the oven accessory (tray, wire grill, etc.) with food and place it in the preheated oven. Remove any excessive pieces of greaseproof paper hanging from the accessory or container to avoid the risk of touching the oven heating elements. Never use greaseproof paper at an oven temperature higher than the maximum use temperature specified on the greaseproof paper you are using. Never place greaseproof paper on the oven base.
- **Do not place baking trays, plates or aluminium foil directly on the bottom of the oven. The accumulated heat can damage the base of the oven.**
- Close the oven door during grilling. Hot surfaces may cause burns!
- Food not suitable for grilling carries a fire hazard. Grill only food that is suitable for heavy grill fire. Also, do not place the food too far in the back of the grill. This is the hottest area and fatty foods may catch fire.



Maintenance and cleaning safety

- Wait for the product to cool before cleaning the product. Hot surfaces may cause burns!
- Never wash the product by spraying or pouring water on it! There is an electric shock hazard!
- Do not clean the product with steam cleaners as this may cause an electric shock.
- Do not use harsh abrasive cleaners, metal scrapers, wire wool or bleach materials to clean the oven front door glass / (if present) oven upper door glass. These materials can cause glass surfaces to be scratched and broken.

High temperature self-cleaning (Pyrolysis)

- During self-cleaning, the surfaces become hotter than in standard use. Keep children away.
- Hot surfaces cause burns! Do not touch the product during self-cleaning and keep children away from the product. Wait at least 30 minutes before removing the residue.
- During self-cleaning, smoke will be released due to the burning of food residues. Ventilate your kitchen well during the cleaning process.
- Before starting the cleaning, clean the outer surfaces of the oven and the food residues inside the oven with soapy cloth. Remove all accessories and cooking utensils from the oven. If your product has a pyro proof accessory (resistant to high temperature self-cleaning), you do not need to remove these accessories from the oven.

General warnings about cooking in the oven



WARNING! Risk of fire!

- Do not place aluminium foil or baking trays on the base of the oven when in use. Heat is reflected downwards and can damage the oven and the cabinets beneath.
- Do not line the grill tray or any baking trays with aluminium foil. The reflected heat can damage the heater.



2. Environmental Instructions

Waste regulation

Compliance with the WEEE Directive and disposing of the Waste Product

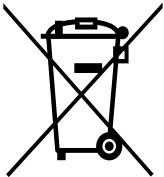

This product complies with EU WEEE Directive (2012/19/EU). This product bears a classification symbol for waste electrical and electronic equipment (WEEE).

This product has been manufactured with high quality parts and materials which can be reused and are suitable for recycling. Do not dispose of the waste product with normal domestic and other wastes at the end of its service life. Take it to the collection centre for the recycling

of electrical and electronic equipment. Please consult your local authorities to learn about these collection centres. Appropriate disposal of used appliance helps prevent potential negative consequences for the environment and human health.

Compliance with RoHS Directive:

The product you have purchased complies with EU RoHS Directive (2011/65/EU). It does not contain harmful and prohibited materials specified in the Directive.

Package information

- Packaging materials of the product are manufactured from recyclable materials in accordance with our National Environment Regulations. Do not dispose of the packaging materials together with the domestic or other wastes. Take them to the packaging material collection points designated by the local authorities.

Recommendations for energy saving

The following suggestions will help you use your product in an ecological and energy-efficient way:

- Defrost frozen food before cooking.
 - In the oven, use dark or enamelled containers that transmit heat better.
 - Turn off the product 5 to 10 minutes before the end time of cooking for prolonged cooking. Now you can save up to 20% electricity by using heat.
 - If specified in the recipe or user manual, always preheat. Do not open the oven door frequently during cooking.
-

3. Your product

Product introduction

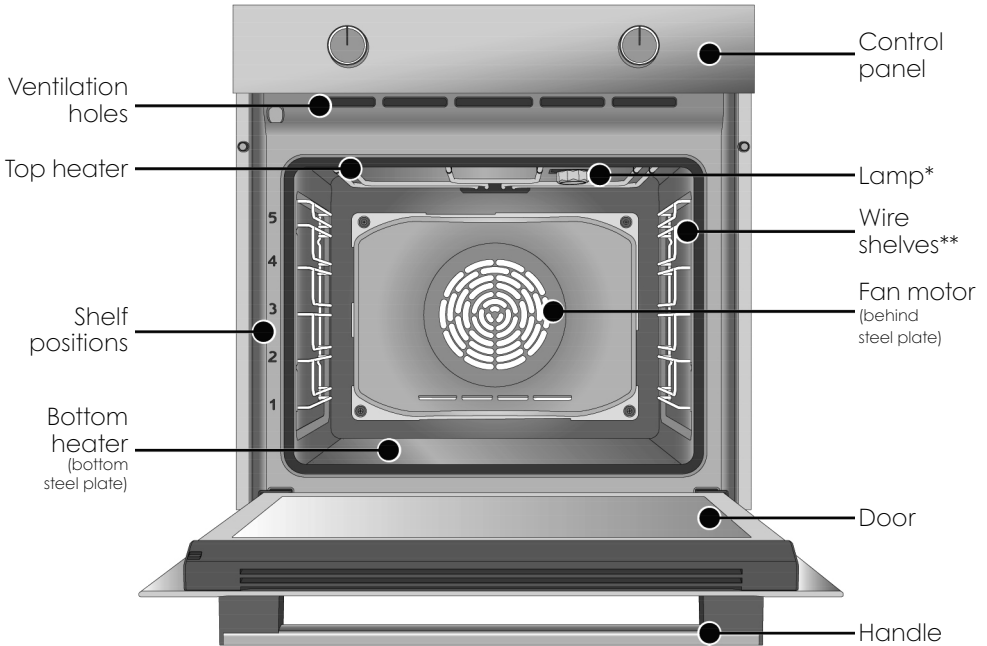

*It depends on the model. Your product may not have a lamp, or the type and location of the lamp may differ from the illustration.

**It depends on the model. Your product may be without wire shelves. In the illustration, wire shelves are shown as examples.

Product control panel introduction and usage

In this section, you can find the overview and basic uses of the product's control panel. There may be differences in images and some features depending on the type of product.

Oven control

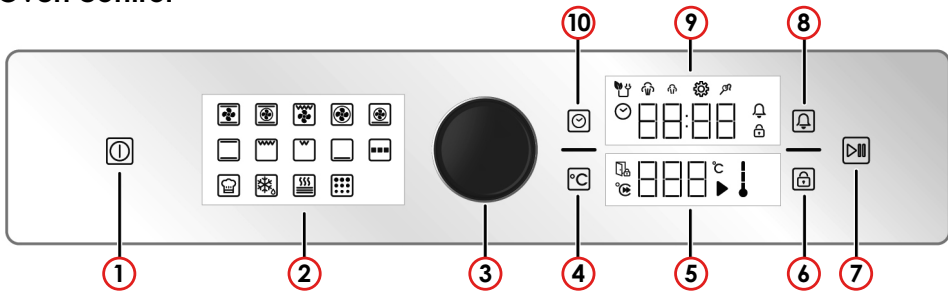

- ① On/Off key
- ② Function display
- ③ Oven control knob
- ④ Temperature key
- ⑤ Temperature display
- ⑥ Key lock key
- ⑦ Cooking start/stop key
- ⑧ Alarm key
- ⑨ Clock/time display
- ⑩ Time and settings key

Oven control knob

With the oven control knob, you can control the settings in the clock/time display and temperature display. You can navigate between these settings by turning the oven control knob to the right/ left, you can activate and confirm the settings by pressing.

Temperature knob

You can select the temperature you want to cook with the temperature knob. To select, turn on the oven by touching the ① key for about 2 seconds. Then, rotate the temperature selection knob to the right/left.

Temperature indicator

You can understand the oven interior temperature from the inner temperature symbol on the display. The symbol appears on the display when the cooking starts and each grades of the inner temperature symbol will be lit as inner temperature reaches to the set temperature.

Function display

The function display contains the operating functions of your oven. Each function is activated by touching on it. All functions on the screen are schematic; they may not be available on your product. The operating functions available on your product are explained in the "Oven operating functions" section.

Displays

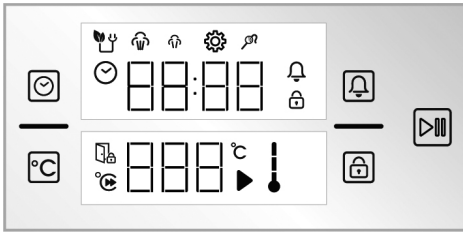

Keys:

- Time and settings key
- Temperature key
- Key lock key
- Alarm key
- Cooking start/stop key

Clock/time display

- Cooking time/Day time symbol
- Alarm symbol
- Settings symbol
- Key lock symbol
- Low level steam symbol*
- High level steam symbol*
- Meat probe symbol*
- Eco fan cooking symbol

*It varies depending on the product model. It may not be available on your product.

Temperature display













- Cooking symbol
- Temperature symbol
- Oven inner temperature symbol
- Quick heating (booster) symbol
- Door lock symbol*

*It varies depending on the product model. It may not be available on your product.

Oven operating functions

On the function table; the operating functions you can use in your oven and the highest and lowest temperatures that can be set for these functions are shown. The order of the operating modes shown here may differ from the arrangement on your product.

Function symbol	Function description	Temperature range (°C)	Description and use
	Operating with fan	-	The oven is not heated. Only the fan (on the back wall) operates. Frozen food with granules is slowly defrosted at room temperature, cooked food is cooled. The time required to thaw a whole piece of meat is longer than the food with grains.
	Top and bottom heating	40 - 280	Food is heated from above and below at the same time. Suitable for cakes and stews in baking moulds or cakes and pastries. Cooking is done with a single tray.
	Bottom heating	40 - 220	Only lower heating is on. It is suitable for foods that need browning on the bottom.

Function symbol	Function description	Temperature range (°C)	Description and use
	Fan assisted bottom/top heating	40 - 280	The hot air heated by the upper and lower heaters is distributed equally and rapidly throughout the oven with the fan. Cooking is done with a single tray.
	Fan Heating	40 - 280	The hot air heated by the fan heater is distributed equally and rapidly throughout the oven with the fan. It is suitable for multi-tray cooking of your food at different shelf levels.
	Eco fan cooking	160 - 220	In order to save energy, you can use this function instead of using "Fan Heating". Cooking time will be slightly longer. See Page 25 how to use.
	Pizza function	40 - 280	The lower heater and fan heating work. It is suitable for cooking pizza.
	"3D" function	40 - 280	Upper heating, lower heating and fan heating work. All parts of the product are cooked equally and quickly. Cooking is done with a single tray.
	Low grill	40 - 280	The small grill on the oven ceiling works. It is suitable for grilling smaller amounts.
	Full grill	40 - 280	The large grill on the oven ceiling works. It is suitable for grilling in large amounts.
	Fan assisted full grill	40 - 280	The hot air heated by the large grill is quickly distributed into the oven with the fan. It is suitable for grilling in large amounts.
	Keep warm	40 - 100	It is used to keep the food at a temperature ready for service for a long time.
	Pyrolysis	-	It is used for self-cleaning of the oven at high temperature. Read the explanations in the maintenance and cleaning section for this function.
	Bread function	-	It is used for baking bread. The set incoming temperature and time cannot be changed.
	Extra function activation	-	It is used to activate run functions that do not appear on the function display at first start-up.

Product accessories

There are various accessories in your product. In this section, the description of the accessories and the descriptions of the correct usage are available. Depending on the product model, the supplied accessory varies. All accessories described in the user guide may not be available in your product.

NOTICE: The trays in your product may be deformed by the effect of the temperature. This has no effect on the function. Deformation disappears when the tray cools down.

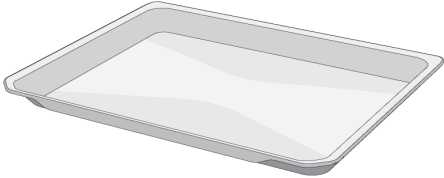
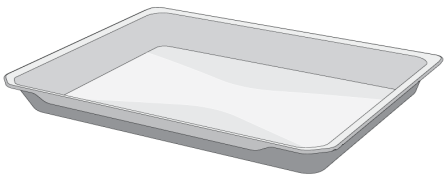
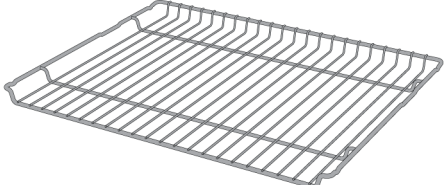
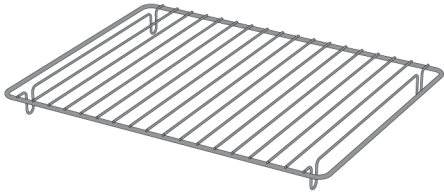
	<p>Standard tray It is used for pastries, frozen foods and frying large pieces.</p>
	<p>Deep tray It is used for pastries, frying large pieces, juicy food or for the collection of flowing oils when grilling.</p>
	<p>Wire grill It is used for frying or placing the food to be baked, fried and stewed on the desired shelf.</p>
	<p>Wire grill in tray By placing it in the tray (if provided), it is ensured that the oils flowing while grilling are collected in the tray and thus the contamination of the oven is prevented. Wire grill in tray is not suitable to use with Deep tray.</p>

Use of product accessories

Cooking shelves

There are 5 levels of shelf position in the cooking area. You can also see the order of the shelves in the numbers on the front frame of the oven.

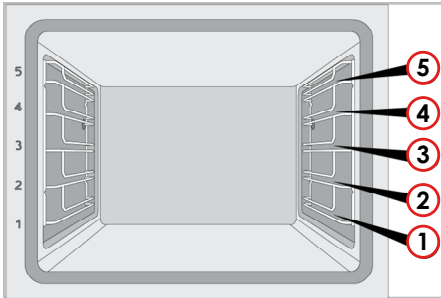

Placing the wire grill on the cooking shelves

It is crucial to place the wire grill on the wire side shelves properly. While placing the wire grill on the desired shelf, the open section must be on the front. For better cooking, the wire grill must be secured with the stopper on the wire shelf. It must not pass over the stopper to contact with the rear wall of the oven.

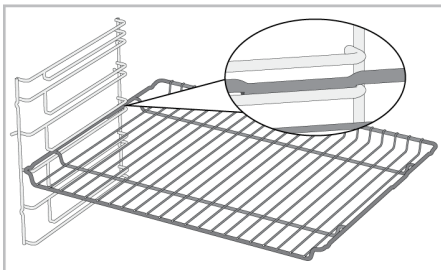

Placing the tray on the cooking shelves

It is also crucial to place the trays on the wire side shelves properly. While placing the tray on the desired shelf, its side designed for holding must be on the front. For better cooking, the tray must be secured with the stopper on the wire shelf. It must not pass over the stopper to contact with the rear wall of the oven.

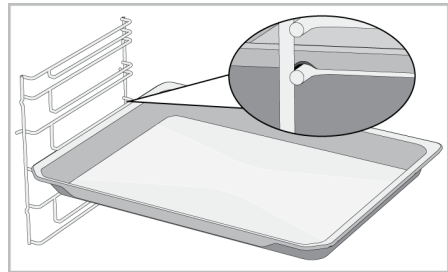

Stopper function of the wire grill

There is a stopper function to prevent the wire grill from tipping out of the wire shelf. With this function, you can easily and safely take out your food. While removing the wire grill, you can pull it forward until it reaches the stopper. You must pass over the stopper to remove it completely.

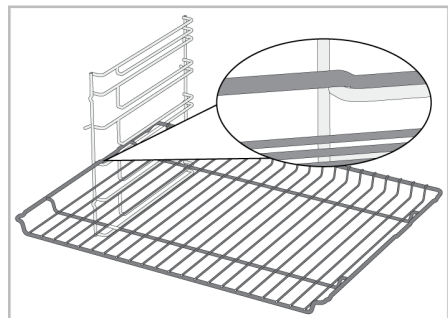

Stopper function of the wire grill tray

There is also a stopper function to prevent the tray from tipping out of the wire shelf. While removing the tray, release it from the rear lock and pull it towards yourself until it reaches the stopper. You must pass over the stopper to remove it completely.

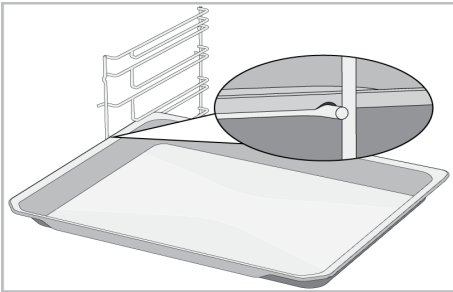

Proper placement of the wire grill and tray on the telescopic rails

Thanks to telescopic rails, trays or the wire grill can be easily installed and removed. When using trays and wire grills with the telescopic rail, care should be taken that the pins, on the front and back of the telescopic rails, rest against the edges of the grill and the tray (shown in the figure).

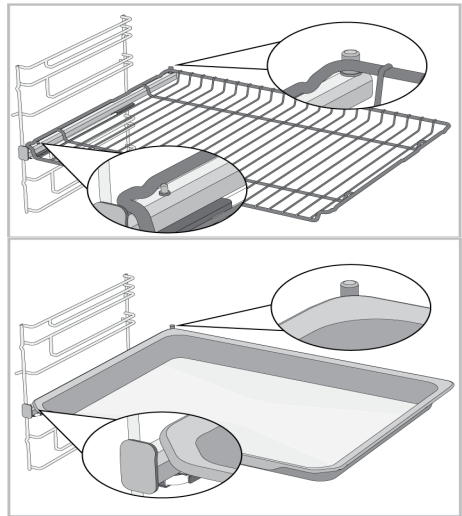



Technical specifications

General specifications	
Product external dimensions (height/width/depth)	595mm / 594mm / 567mm
Oven installation dimensions (height/width/depth)	590 or 600mm / 560mm / min. 550mm
Voltage / frequency	220-240 V ~ 50 Hz
Cable type and cross section used / suitable for use in the product	min. H05VV-FG 3 x 1,5mm ²
Total power consumption	3,4 kW
Inner lamp type (A)	240 V/15-25 W/E14 SES / T 300°C
Inner lamp type (B)	25 W, G9, 300°C
Oven type	Multifunction oven

Basics: Information on the energy label of electrical ovens is given in accordance with the EN 60350-1 / IEC 60350-1 standard. Those values are determined under standard load with bottom-top heater or fan assisted heating (if any) functions.

Energy efficiency class is determined in accordance with the following prioritization depending on whether the relevant functions exist on the product or not: 1-Eco fan heating, 2-Fan Heating 3- Fan assisted low grill, 4-Top and bottom heating.

-  Technical specifications may be changed without prior notice to improve the quality of the product.
-  Figures in this manual are schematic and may not exactly match your product.
-  Values stated on the product labels or in the documentation accompanying it are obtained in laboratory conditions in accordance with relevant standards. Depending on operational and environmental conditions of the product, these values may vary.

4. First use

Before you start using your product, it is recommended to do the following in the following sections.

First time setting

i Always set the time of day before using your oven. If you do not set it, you cannot cook in some oven models.

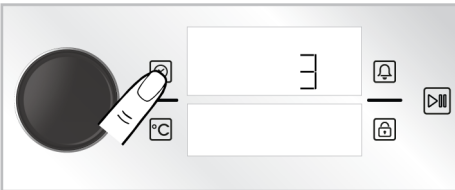

1. When after the oven is energized for the first time, "12:00" will appear on the time/clock display.
 2. When the oven in stand-by mode, activate the settings menu by touching  key for about 3 seconds.
- » The 3-2-1 count down is displayed. When the countdown expires, the settings menu is activated.

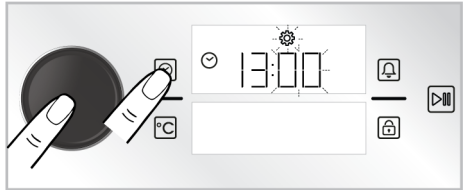
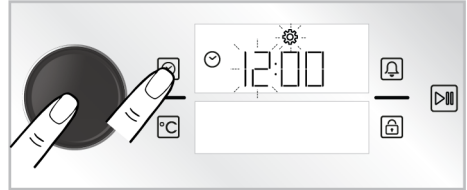

3. Press the oven control knob or touch  key once to activate the hour field.

- » Hour field and  symbol flashes on the time/clock display.



5. Set the minute by rotating the oven control knob to right/left. Confirm the time setting by pressing on the oven control knob or touching  key.
- » The time of day is set and the  symbol appears on the time/clock display always on.

i If the initial time is not set, clock will run starting from 12:00. You can change the time of day setting later, as described in the "Settings" section.

i Time of the day settings are cancelled in case of long-term power failure. It needs to be re-adjusted.

First cleaning

1. Remove all packaging materials.
2. Remove all accessories from the oven provided within the product.
3. Turn the product on for 30 minutes and then, turn it off. This way, residues and layers that may have remained in the oven during production are burned and cleaned.
4. When operating the product, select the highest temperature and the operating function that all the heaters in your product operate. See "Oven operating functions". You can learn how to operate the oven in the following section.
5. Wait for the oven to cool.
6. Wipe the surfaces of the product with a wet cloth or sponge and dry with a cloth.

Before using the accessories;

Clean the accessories you remove from the oven with detergent water and a soft cleaning sponge.

NOTICE The surface might get damaged by some detergents or cleaning materials. Do not use aggressive detergents, cleaning powders/creams or any sharp objects during cleaning.

NOTICE Smoke and smell may emit for a couple of hours during the initial operation. This is quite normal. Ensure that the room is well ventilated to remove the smoke and smell. Avoid directly inhaling the smoke and the smell that emits.

5. How to operate the oven

General information on oven usage

Cooling fan (It may not exist on your product.)

Your product has a cooling fan. The cooling fan is activated automatically when necessary and cools both the front of the product and the furniture. It is automatically deactivated when the cooling process is finished. Hot air comes out over the oven door. Do not cover these ventilation openings with anything. Otherwise, the oven may overheat.

The cooling fan continues to operate during oven operation or after the oven is turned off (approximately 20-30 minutes). If you cook by programming the oven timer, at the end of the cooking time, the cooling fan turns off with all functions. The cooling fan running time cannot be determined by the user. It turns on and off automatically. This is not an error.

Oven lighting

The oven lamp is turned on when the oven starts cooking. In some models, the lamp is on during cooking, while in some models it turns off after a certain time. If the product door is opened while the oven is operating or in the closed position, the oven lamp turns on automatically.

i In some operating functions, the lamp does not light due to energy savings.

Operation of the oven control unit

General warnings for the oven control unit

- i** The maximum time that can be set for the end of the time is 5:59 hours. In warn keeping function, this time is 23:59 hours. In the event of a power failure, the cooking and cooking time set will be cancelled.
- i** While making any adjustments, the relevant symbols flash on the display. A short time should be waited for the settings to be saved.
- i** If any cooking setting has been made, the time of the day cannot be adjusted.
- i** If cooking time is set when cooking starts, the remaining time is displayed on the display.
- i** If the quick preheat (booster) setting is enabled on your control unit, the  symbol appears on the display when you start cooking and the oven reaches the temperature you set for cooking quickly. For the quick preheat (booster) setting, please see **"Settings"** section.

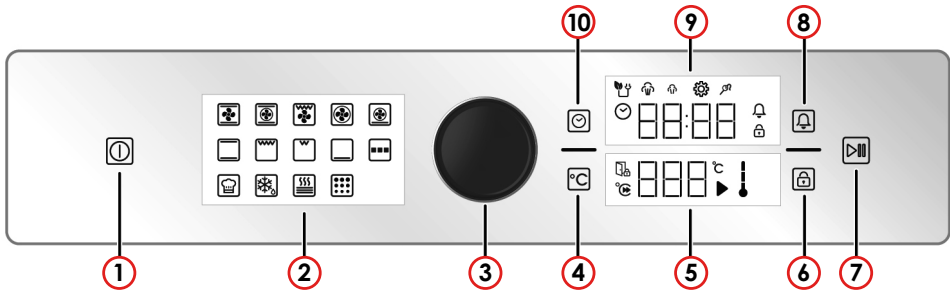

- ① On/Off key
- ② Function display
- ③ Oven control knob
- ④ Temperature key
- ⑤ Temperature display
- ⑥ Key lock key
- ⑦ Cooking start/stop key
- ⑧ Alarm key
- ⑨ Clock/time display
- ⑩ Time and settings key

Clock/time display

- Cooking time/Day time symbol
- Alarm symbol
- Settings symbol
- Key lock symbol
- Low level steam symbol*
- High level steam symbol*
- Meat probe symbol*
- Eco fan cooking symbol

*It varies depending on the product model. It may not be available on your product.

Displays

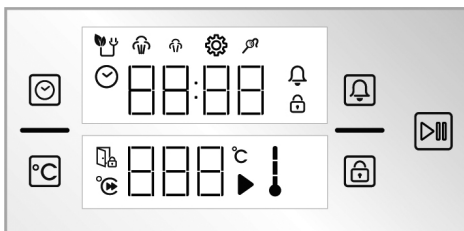

Temperature display

- Cooking symbol
- Temperature symbol
- Oven inner temperature symbol
- Quick heating (booster) symbol
- Door lock symbol*

*It varies depending on the product model. It may not be available on your product.

Keys:

- Time and settings key
- Temperature key
- Key lock key
- Alarm key
- Cooking start/stop key

Turning on the oven

1. Turn on the oven by touching (ⓘ) the key.
- » After the oven is turned on, the first operating function is displayed on the display. On this display, the operating function, temperature, cooking time, alarm can be set.

i If no settings are made on this display, the oven will turn off in about 5 minutes and the time of day will appear on the display.

Turning off the oven

Turn off the oven by touching the ⓘ key. The time of day appears on the display.

Manual cooking to select temperature and oven operating function

You can cook by making a manual control (at your own control) without setting the cooking time by selecting the temperature and operating function specific to your food. The "Top and bottom heating" function and 180 °C settings are shown as an example in the images.

1. Turn on the oven by touching the ⓘ key.
2. Touch on the operating function you want to cook on function display.

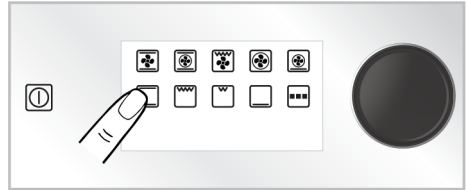

3. Touch on the operating function you want to cook on function display. If the function you want to select is not among the first operating functions that appear on the function display, you can activate the lower row of operating functions by touching on "Extra function activation".

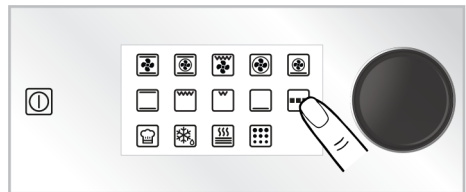

4. The predefined temperature for the operating function you selected appears on the temperature display. To change this temperature, touch [°C] key and rotate the oven control knob to right/left.
- » The °C symbol blinks on the temperature display.

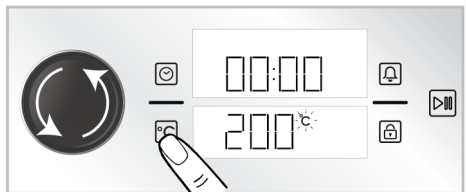

i If you change the operating function after changing the predefined temperature for the operating functions, the temperature you set last appears on the display. However, if the set temperature is not within the temperature range of the selected operating function, the highest adjustable temperature of that operating function appears.

5. Confirm the set temperature by touching **°C** key.
- » The **°C** symbol appears on the temperature display.

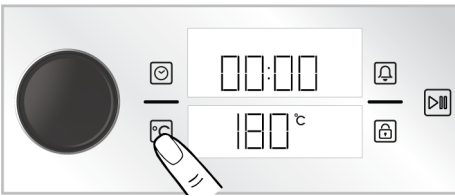

6. After setting the operating function and temperature, touch the **▶** key to start cooking.

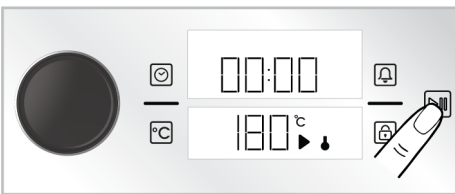

- » Your oven will start operating at the selected operating function and temperature immediately. **▶** and the **!** symbols will appear on the temperature display. The cooking time starts to count on the display. Each stage of the

! symbol lights up as the oven interior temperature reaches the set temperature. The oven does not turn off automatically since manual cooking is done without setting the cooking time. You have to control cooking and turn it off. When your cooking is complete, touch the **▶** key to end cooking or touch the **⓪** key to turn off the oven completely.

Cooking by setting the cooking time;

You can have the oven turn off automatically at the end of the time by selecting the temperature and operating function specific to your food and setting the cooking time on the control unit. The "Top and bottom heating" function, 180 °C and 45 minute settings are shown as an example in the images.

1. Turn on the oven by touching the **⓪** key.
2. Touch on the operating function you want to cook on function display.

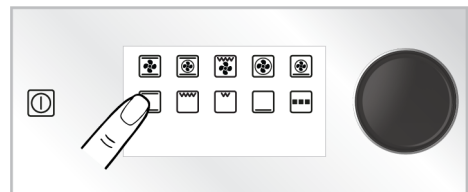

3. Touch on the operating function you want to cook on function display. If the function you want to select is not among the first operating functions that appear on the function display, you can activate the lower row of operating functions by touching on "Extra function activation".

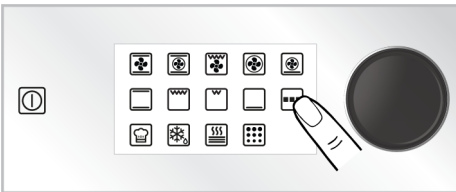

4. The predefined temperature for the operating function you selected appears on the temperature display. To change this temperature, touch $^{\circ}\text{C}$ key and rotate the oven control knob to right/left.

- » The $^{\circ}\text{C}$ symbol blinks on the temperature display.

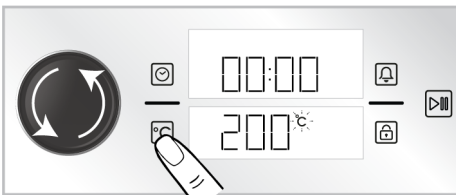

- i** If you change the operating function after changing the predefined temperature for the operating functions, the temperature you set last appears on the display. However, if the set temperature is not within the temperature range of the selected operating function, the highest adjustable temperature of that operating function appears.

5. Confirm the set temperature by touching $^{\circ}\text{C}$ key.

- » The $^{\circ}\text{C}$ symbol appears on the temperature display.

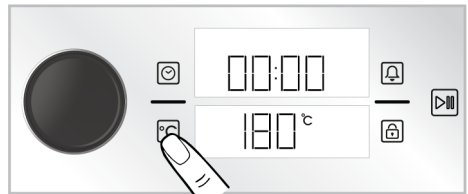

6. Press oven control knob or touch the \odot key once for setting the cooking time.

- » The \odot symbol blinks on the display and the 30 minute set cooking time is appear on the clock/time display.

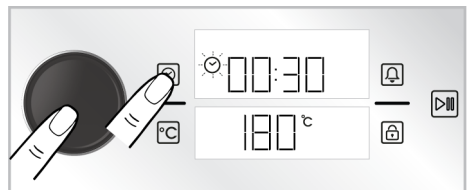

i After setting the operation function and temperature, cooking time will be set 30 minutes by touching the  key or by pressing on the oven control knob directly for quick setting of the cooking time and change the time by rotating the oven control knob to right/left.

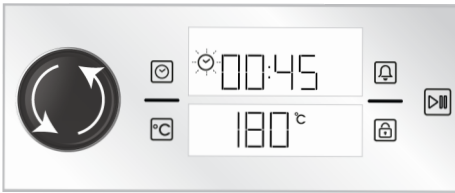

7. Set the cooking time by rotating the oven control knob. Confirm the cooking time by touching  key.





i The cooking time increases by 1 minute in the first 15 minutes, after 15 minutes it increases by 5 minutes.

8. After setting the operating function, temperature and cooking time, touch the  key to start cooking.



» Your oven will start operating immediately at the selected function and temperature. The set cooking time starts to count down.  and the  symbols will appear on the temperature display. Each stage of the  symbol lights up as the oven interior temperature reaches the set temperature. After the set cooking time is completed, “End” appears on the temperature display, the timer give an audio warning and cooking stops.

9. The audio warning sounds for one minute. If the  key is touched while the audio warning sounds and “End” appears on the temperature display, the oven continues to operate indefinitely. If  key is touched, the oven turns off. If any key other than these keys is touched, the audible warning will be interrupted.

Eco fan cooking

In order to save energy, you can use this function instead of using “Fan Heating” in the range of 160-220 °C. But; cooking time will be slightly longer.

1. Turn on the oven by touching the  key.
2. Touch and keep the “Fan Heating” on function display.

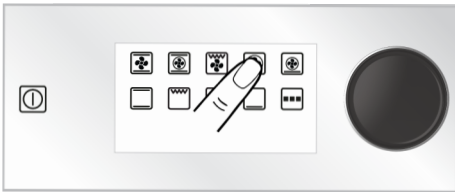

- » The 3-2-1 count down is displayed. When the countdown expires, a fan symbol will appear and the “Eco fan cooking” is activated.



3. You can change the set temperature and set cooking time as described in previous sections. Then you start the cooking.

i In “Eco fan cooking”, the lamp light shorter than the other cooking function during cooking due to energy savings.

Bread function

Your oven has a “Bread function” specially defined for bread making. The temperature and time settings of the function are fixed.

Ingredients

- 500 g flour
- 15g sugar
- 10g instant yeast
- 10g sunflower oil
- 8g salt
- 300 ml water (35°C)

For the top of the dough

- 2 teaspoon sunflower oil

Preparation

1. Sift flour into a deep bowl. Add sugar on the flour and mix it homogeneously.
2. Open the middle of the flour and add the yeast, salt and sunflower oil. Starting from the sides of the bowl, pour the warm water gradually.
3. Knead the dough by hand or in a dough mixer for about 10-15 minutes.
4. Turn the kneaded dough by hand a few times and put it in a bowl. Apply 1 teaspoon of sunflower oil on the dough and cover it with stretch film so that it touches the dough.
5. Cover the dough with stretch film, cover it with a thick cloth and leave it to rise at room temperature.

6. Take your dough, which has been fermented for 60 minutes, on the counter and fold it 4-5 times and remove the air inside. Apply 1 teaspoon of sunflower oil on the dough and cover it with stretch film so that it touches the dough. Ferment the dough at room temperature for another 30 minutes.
7. When the dough has finished fermenting, shape the dough into salmon and place it on a baking tray. Make 3-4 scratches on your dough with the help of a knife.
8. Place the tray on shelf 3 of your oven.
9. Turn on the oven by touching  the key.
10. Touch on the “Extra function activation” on function display.

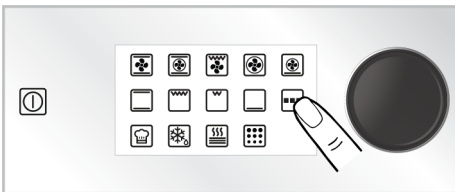

11. Touch on the “Bread function” on the lower row of function display.

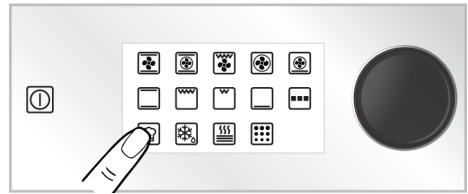

12. Touch the  key to start cooking.

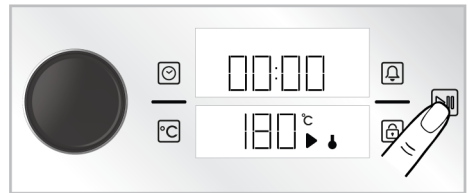



13. At the end of the cooking time, the audible warning sounds for one minute. If the  is touched, the oven turns off. If any key other than these keys is touched, the audible warning will stop.

Settings



- i** The 3-2-1 count down is displayed on the menus or settings that shall be activated by touching for a long period. When the count down expires, the relevant menu or setting is activated.

Activating key lock

By using the key lock feature, you can safeguard the timer from interference.

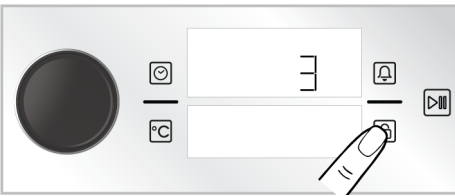
1. Touch the  key until the  symbol appears on the time/clock display.



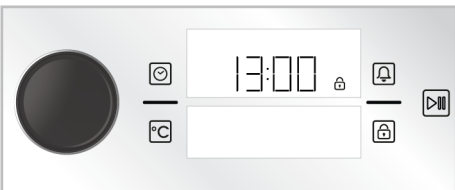

- » The 3-2-1 count down is displayed. When the countdown expires, the  symbol appears on the time/clock display and the key lock is activated. When any key is touched or the oven control knob pressed when the key lock is set, the timer sounds an audible signal and the  symbol flashes.



- i** The key lock will not be cancelled in case of power failure.

Deactivating the key lock



1. Touch the  key until the  symbol appears on the time/clock display.
- » The 3-2-1 count down is displayed. When the countdown expires, the  symbol disappears and the key lock is disabled on the time/clock display.

Setting the alarm

You can also use the timer of the product for any warning or reminder other than cooking.

The alarm clock has no effect on the oven operating functions. Used for warning purposes. For example, you can use the alarm clock when you want to turn the food in the oven at a certain time. As soon as the time you set has expired, the clock gives you an audible warning.

- i** Maximum alarm time can be 23 hours and 59 minutes.

1. Touch the  key once to set the alarm time.
- » The  symbol starts to flash on the time/clock display.
2. Set the alarm time by rotating the oven control knob. Touch the  key again to confirm the setting.

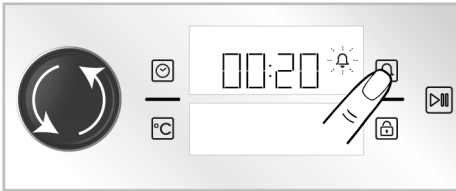
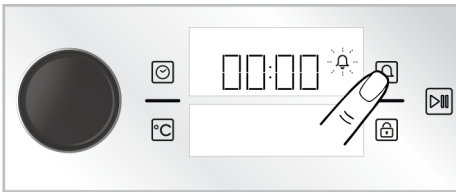

2. Set the alarm time to **“00:00”** by rotating the oven control knob to right/left.

Setting the volume

You may set the volume of the timer. Your oven shall be off to perform this operation.

1. When the oven in stand-by mode, activate the settings menu by touching  key for about 3 seconds.

- » The 3-2-1 count down is displayed. When the countdown expires, the settings menu is activated.

- » The  symbol illuminates continuously and the alarm time starts to count down on the time/clock display.

3. After the alarm time has expired, the  symbol starts flashing and gives you an audible warning.

 If the alarm time and cooking time are set at the same time, the shorter time is displayed on the time/clock display.

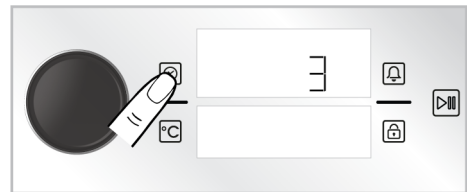

2. Rotate the oven control knob to right/left until the **“b-1”** or **“b-2”** appears on the time/clock display.

Turning off the alarm

1. At the end of the alarm period, the warning sounds for one minute. Touch any key to stop the audible warning.

- » The audible warning is stopped.

If you want to cancel the alarm;

1. Touch the  key once to cancel alarm time.

- » The  symbol starts to flash on the time/clock display.



3. Activate the volume setting by touching the  key or pressing to oven control knob.

- »  symbol flashes on the time/clock display.

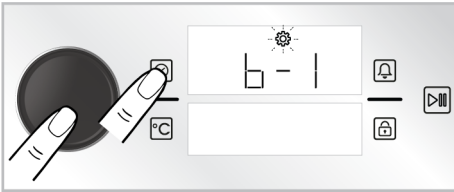

4. Set the desired volume level by rotating oven control knob to right/left.
5. Confirm the selected volume level by touching the key or pressing to oven control knob.

Setting the screen brightness



You may set the brightness of the timer screen. Your oven shall be off to perform this operation.

1. When the oven in stand-by mode, activate the settings menu by touching  key for about 3 seconds.
 - » The 3-2-1 count down is displayed. When the countdown expires, the settings menu is activated.

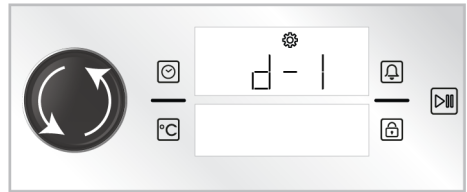

2. Rotate the oven control knob to right/left until the “**d-1**”, “**d-2**” or “**d-3**” appears on the time/clock display.



3. Activate the brightness setting by touching the  key or pressing to oven control knob.
 - »  symbol flashes on the time/clock display.

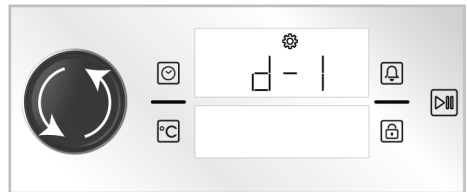



4. Set the desired brightness level by rotating oven control knob to right/left.
5. Confirm the selected brightness level by touching the  key or pressing to oven control knob.

Setting the Quick pre-heating (Booster) function

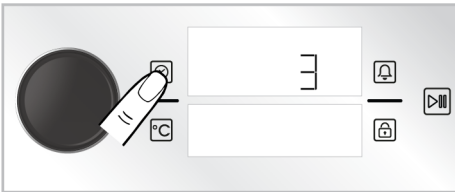

You may operate the cooking automatically with the timer using the quick pre-heating function. For this purpose, you shall activate the quick pre-heating setting. Your oven shall be off to perform this operation.

1. When the oven in stand-by mode, activate the settings menu by touching  key for about 3 seconds.
 - » The 3-2-1 count down is displayed. When the countdown expires, the settings menu is activated.

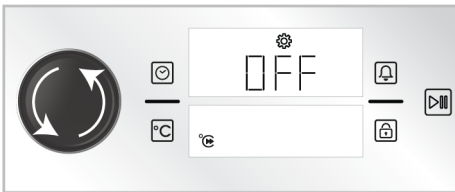

2. Rotate the oven control knob to right/left until the  symbol and **"OFF"** appears on the time/clock display.



3. Activate the quick pre-heating (booster) setting by touching the  key or pressing to oven control knob.
 - »  symbol flashes on the time/clock display.

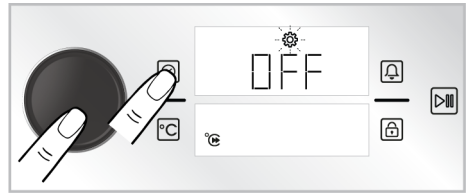

4. Rotate the oven control knob to right/left to change the **"OFF"** setting displayed on the time/clock display to the **"ON"** setting.

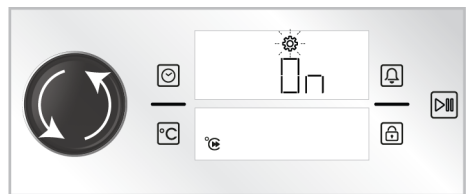

5. Confirm the quick pre-heating (booster) setting by touching the  key or pressing to oven control knob.



i You may turn off the quick pre-heating setting with the same procedure. By bringing it to the **"OFF"** setting, you may cancel the quick pre-heating setting.

Changing the time of day

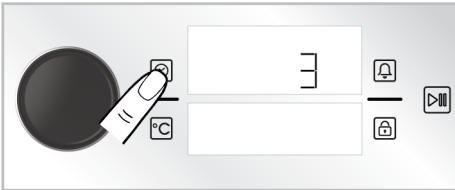

To change the time of day that you have previously set.

1. When the oven is in stand-by mode, activate the settings menu by touching  key for about 3 seconds.
 - » The 3-2-1 count down is displayed. When the countdown expires, the settings menu is activated.



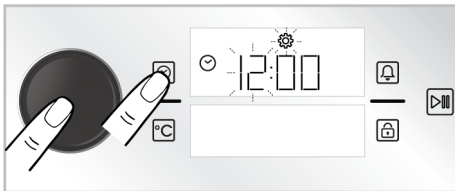

2. Press the oven control knob or touch  key once to activate the hour field.
 - » Hour field and  symbol flashes on the time/clock display.

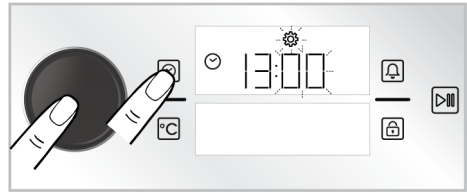

3. Set the hour by rotating the oven control knob to right/left and press the oven control knob or touch  key once to activate the minute field.
 - » Minute field and  symbol flashes on the time/clock display.



4. Set the minute by rotating the oven control knob to right/left. Confirm the time setting by pressing on the oven control knob or touching  key.
 - » The time of day is set and the  symbol appears on the time/clock display always on.

6. General information about cooking

This section describes tips on preparing and cooking your food. In addition, you can also find some of the foods tested as producers and the most appropriate settings for these foods. Appropriate oven settings and accessories for these foods are also indicated.

General warnings about cooking in the oven

- While opening the oven door during or after cooking, hot-burning steam may emerge. The steam may burn your hand, face and / or eyes. When opening the oven door, stay away.
- Intense steam generated during cooking may form condensed water drops on the interior and exterior of the oven and on the upper parts of the furniture due to the temperature difference. This is a normal and physical occurrence.
- The cooking temperature and time values given for foods may vary depending on the recipe and amount. For this reason, these values are given as ranges.
- Always remove unused accessories from the oven before you start cooking. Accessories that will remain in the oven may prevent your food from being cooked at the correct values.
- For foods that you will cook according to your own recipe, you can reference similar foods given in the cooking tables.
- Using the supplied accessories ensures you get the best cooking performance. Always observe the warnings and information provided by the manufacturer for the external cookware you will use.
- Cut the greaseproof paper you will use in your cooking in suitable sizes to the container you will cook. Greaseproof papers that are overflowing from the container can create a risk of burns and affect the quality of your cooking. Use the greaseproof paper you will use in the temperature range specified.
- For good cooking performance, place your food on the recommended correct shelf. Do not change the shelf position during cooking.

Pastries and oven food General Information

- We recommend using the accessories of the product for a good cooking performance. If you are going to use an external cookware, prefer dark, non-sticking and heat resistant ware.

- If preheating is recommended in the cooking table, be sure to put your food in the oven after preheating.
- If you are going to cook using cookware on the wire grill, place it in the middle of the wire grill, not near the back wall.
- All materials used in making pastry should be fresh and at room temperature.
- The cooking status of the products may vary depending on the amount of food and the size of the cookware.
- Metal, ceramic and glass moulds extend the cooking time and the bottom surface of pastry foods do not brown evenly.
- If you use cooking paper during cooking, a little browning may be observed on the bottom surface of the food. In this case, you may need to extend your cooking time about 10 minutes.
- The values specified in the cooking tables are determined as a result of the tests carried out in our laboratories. Values suitable for you may differ from these values.
- Place your food on the appropriate shelf recommended in the cooking table. Refer to the bottom shelf of the oven as shelf 1.
- If the cake is moist, use a small amount of liquid or reduce the temperature by 10°C.
- If the top of the cake is burnt, put it on the lower shelf, lower the temperature and increase the baking time.
- If it is cooked well inside but the outside is sticky, use a smaller amount of liquid, reduce the temperature and increase the cooking time.

Tips for cooking pastries

- If the pastry is too dry, increase the temperature by 10 ° C and shorten the cooking time. Wet the dough sheets with a sauce consisting of milk, oil, egg and yoghurt mixture.
- If the pastry is getting cooked slowly, make sure that the thickness of the pastry you have prepared does not overflow the tray.
- If the pastry is browned on the surface but the bottom is not cooked, make sure that the amount of sauce you will use for the pastry is not too much at the bottom of the pastry. For an even browning, try to spread the sauce evenly between the dough sheets and the pastry.
- Bake your pastry in the position and temperature appropriate to the cooking table. If the bottom is still not browned enough, place it on a bottom shelf for the next cooking.

Tips for baking cakes

- If the cake is too dry, increase the temperature by 10°C and shorten the baking time.

Cooking table for pastries and oven food

Food	Tray amount	Accessory to be used	Operating function	Shelf position	Temperature (°C)	Cooking time (min) (approx.)
Cakes in tray	Single tray	Standard tray*	Top and bottom heating	3	180	30 - 40
Cakes in mould	Single tray	Cake mould on wire grill**	Fan Heating	2	180	30 - 40
Small cakes***	Single tray	Standard tray*	Top and bottom heating	3	160	25 - 35
	Single tray	2 - Standard tray*	Fan Heating	3	150	25 - 35
	2 trays	4 - Pastry tray*	Fan Heating	2 - 4	150	25 - 35
Sponge cake***	Single tray	Round cake mould, 26 cm in diameter with clamp on wire grill**	Top and bottom heating	2	150	30 - 40
	Single tray	Round cake mould, 26 cm in diameter with clamp on wire grill**	Fan Heating	2	160	30 - 40
Cookie	Single tray	Pastry tray*	Top and bottom heating	3	170	25 - 35
	Single tray	Pastry tray*	Fan Heating	3	170	20 - 30
	2 trays	2 - Standard tray* 4 - Pastry tray*	Fan Heating	2 - 4	170	25 - 35
Dough pastry	Single tray	Standard tray*	Fan assisted bottom/top heating	2	180	35 - 45
	2 trays	1 - Standard tray* 4 - Pastry tray*	Fan Heating	1 - 4	180	40 - 50
Rich pastry	Single tray	Standard tray*	Top and bottom heating	2	200	20 - 30
	Single tray	Standard tray*	Fan Heating	3	180	20 - 30
	2 trays	2 - Standard tray* 4 - Pastry tray*	Fan Heating	2 - 4	180	20 - 30
Whole bread	Single tray	Standard tray*	Top and bottom heating	3	200	30 - 40
	Single tray	Standard tray*	Fan Heating	3	200	30 - 40
Lasagna	Single tray	Glass / metal rectangular mould on wire grill**	Top and bottom heating	2 or 3	200	30 - 40
Apple pie***	Single tray	Round black metal mould, 20cm in diameter on wire grill**	Top and bottom heating	3	180	50 - 65
	Single tray	Round black metal mould, 20cm in diameter on wire grill**	Fan Heating	2	170	50 - 65
Pizza	Single tray	Standard tray*	Top and bottom heating	2	200 - 220	10 - 20
	Single tray	Standard tray*	Pizza function	3	250	8 - 15

Food	Tray amount	Accessory to be used	Operating function	Shelf position	Temperature (°C)	Cooking time (min) (approx.)
Shortbread (sweet cookie) ***	Single tray	Standard tray*	Top and bottom heating	3	140	20 - 30
	Single tray	Standard tray*	Fan Heating	3	140	15 - 25
	2 trays	2 - Standard tray* 4 - Pastry tray*	Fan Heating	2 - 4	140	15 - 25
Small cakes	Single tray	Single tray	Eco fan cooking	3	160	25 - 35
Cookie	Single tray	Single tray	Eco fan cooking	3	180	25 - 35
Dough pastry	Single tray	Single tray	Eco fan cooking	3	200	45 - 55
Rich pastry	Single tray	Single tray	Eco fan cooking	3	200	35 - 45

Preheating is recommended for all food.

* These accessories may not be included with your product.

** These accessories are not included with your product. They are commercially available accessories.

*** **Test Foods** - Foods in this cooking table are prepared according to the EN 60350-1 standard to facilitate testing of the product for control institutes.

For Eco fan heating - cooking function

- Do not change the cooking temperature after cooking starts in Eco fan heating -operating function.
- Do not open the door during cooking in the Eco fan heating - operating function. If door is not opened, inner temperature is optimized to save energy and may differ from the display.

Meat, Fish and Poultry

The key points on roasting

- Seasoning it with lemon juice and pepper before cooking all chicken, turkey and large pieces of meat will increase cooking performance.
- It takes 15 to 30 minutes more to cook boned meat than fillet by roasting.
- You should calculate about 4 to 5 minutes of cooking time per centimetre of the meat thickness.
- After the cooking time is over, leave the meat in the oven for about 10 minutes. The juice of the meat is better distributed to the fried meat and does not come out when the meat is cut.
- Fish should be placed on a medium or low level shelf in a heat resistant plate.

Food	Tray amount	Accessory to be used	Operating function	Shelf position	Temperature (°C)	Cooking time (min) (approx.)
Steak (whole) / Roast (1kg)	Single tray	Standard tray*	Fan assisted bottom/top heating	3	15 mins. 250/max, then 180 - 190	60 - 80
Lamb's shank (1.5 - 2.0kg)	Single tray	Standard tray*	Fan assisted bottom/top heating	3	170	85 - 110
Roasted chicken (1.8 - 2kg)	Single tray	Wire grill* Place one tray on a lower shelf	Fan assisted bottom/top heating	2	15 mins. 250/max, then 190	60 - 80
	Single tray	Wire grill* Place one tray on a lower shelf	"3D" function	2	15 mins. 250/max, then 190	60 - 80
Turkey (5.5kg)	Single tray	Standard tray*	Fan assisted bottom/top heating	1	25 mins. 250/max, then 180 - 190	150 - 210
	Single tray	Standard tray*	"3D" function	1	25 mins. 250/max, then 180 - 190	150 - 210
Fish	Single tray	Wire grill* Place one tray on a lower shelf	Fan assisted bottom/top heating	3	200	20 - 30
	Single tray	Wire grill* Place one tray on a lower shelf	"3D" function	3	200	20 - 30

Preheating is recommended for all food.

* These accessories may not be included with your product.

** These accessories are not included with your product. They are commercially available accessories.

Grill

Red meat, fish and poultry meat will quickly turn brown when grilled, hold a beautiful crust and do not dry out. Fillet meats, skewer meats, sausages as well as juicy vegetables (tomatoes, onions, etc.) are particularly suitable for grilling.

General warnings

- Food not suitable for grilling carries a fire hazard. Grill only food that is suitable for heavy grill fire. Also, do not place the food too far in the back of the grill. This is the hottest area and fatty foods may catch fire.
- **Close the oven door during grilling. Never grill with the oven door open. Hot surfaces may cause burns!**
- Place the pieces to be grilled on the wire grill or wire grill tray by distributing them without exceeding the dimensions of the heater.
- Depending on the thickness of the pieces to be grilled, the cooking times given in the table may vary.
- Slide the wire grill or the wire grill tray to the desired level in the oven. If you are cooking on the wire grill, slide the oven tray to the lower shelf to collect the oils. The oven tray you are going to slide should be sized to cover the entire grill area. This tray may not be included with the product. Put some water into the oven tray for easy cleaning.

The key points of the grill

- Prepare foods of similar thickness and weight as much as possible for the grill.

Grilling table

Food	Accessory to be used	Shelf position	Temperature (°C)	Cooking time (min) (approx.)
Fish	Wire grill	4 - 5	250	20 - 25
Chicken pieces	Wire grill	4 - 5	250	25 - 35
Meatball (beef) - 12 pieces*	Wire grill	4	250	20 - 30
Lamb chop	Wire grill	4 - 5	250	20 - 25
Steak - (sliced)	Wire grill	4 - 5	250	25 - 30
Veal chop	Wire grill	4 - 5	250	25 - 30
Vegetable gratin	Wire grill	4 - 5	250	20 - 30
Toast bread*	Wire grill	4	250	1 - 35

It is recommended to preheat for 5 minutes for all grilled food. Turn pieces of food after 1/2 of the total grilling time.

* **Grilling for test foods** - Foods in this cooking table are prepared according to the EN 60350-1 standard to facilitate testing of the product for control institutes.

7. Maintenance and care

General cleaning information

General warnings

- Wait for the product to cool before cleaning the product. Hot surfaces may cause burns!
- Do not apply the detergents directly on the hot surfaces. This may cause a permanent stains.
- The appliance shall be thoroughly cleaned and dried after each operation. Thus, food residues shall be easily cleaned and these residues shall be prevented from burning when the appliance is used again later. Thus, the service life of the appliance extends and frequently faced problems are decreased.
- Do not use steam cleaning products for cleaning.
- Some detergents or cleaning agents may damage the surface. Do not use abrasive detergents, cleaning powders, cleaning creams, descalers or sharp objects during cleaning.
- There is no need for a special cleaning agent for cleaning after each use. Clean the appliance using dish soap, warm water and a soft cloth or sponge and dry with a dry microfibre cloth.
- Be sure to completely wipe off any remaining liquid after cleaning and immediately clean any food splashing around during cooking.

- Do not wash any component of your appliance in a dishwasher.

Inox and stainless surfaces

- Do not use acid or chlorine-containing cleaning agents to clean stainless or inox surfaces and handles.
- Stainless or inox surface may change colour in time. This is normal. After each operation, clean with a detergent suitable for the stainless or inox surface.
- Clean with a soft soapy cloth and liquid (non-scratching) detergent suitable for inox surfaces, taking care to wipe in one direction.
- Remove lime, oil, starch, milk and protein stains on the inox-stainless and glass surfaces immediately without waiting. Stains may rust under long periods of time.

Enamelled surfaces

- After each use, clean the enamel surfaces using dishwashing detergent, warm water and a soft cloth or sponge and dry them with a dry cloth.
- If your product has an easy steam cleaning function, you can make easy steam cleaning for light non-permanent dirt. (See the “Easy steam cleaning” section)

- For persistent stains, the oven and grill cleaner recommended on the website of your product brand and a non-scratching scouring pad can be used. Do not use an external oven cleaner.
- The oven must cool down for cleaning in the cooking area. Cleaning on hot surfaces shall create both fire hazard and damage with enamel surface.
- If there is residual detergent after cleaning, wipe it with cold water and dry with a clean and dry microfibre cloth. Residual detergent residue may damage the glass surface next time.
- Under no circumstances should the dried-up residue on the glass surface be cleaned off with serrated knives, wire wool or similar scratching tools.

Catalytic surfaces

- The side walls in the cooking area can only be covered with enamel or catalytic walls. It varies by model.
- The catalytic walls have a light matte and porous surface. The catalytic walls of the oven should not be cleaned.
- Catalytic surfaces absorb oil thanks to its porous structure and start to shine when the surface is saturated with oil, in this case it is recommended to replace the parts.
- You can remove the calcium stains (yellow stains) on the glass surface with the commercially available descaling agent, with a descaling agent such as vinegar or lemon juice.
- If the surface is heavily soiled, apply the cleaning agent on the stain with a sponge and wait a long time for it to work properly. Then clean the glass surface with a wet cloth.
- Discolourations and stains on the glass surface are normal and not defects.

Glass surfaces

- When cleaning glass surfaces, do not use hard metal scrapers and abrasive cleaning materials. They can damage the glass surface.
- Clean the appliance using dishwashing detergent, warm water and a microfibre cloth specific for glass surfaces and dry it with a dry microfibre cloth.
- Clean plastic parts and painted surfaces using dishwashing detergent, warm water and a soft cloth or sponge and dry them with a dry cloth.
- Do not use hard metal scrapers and abrasive cleaners. It may damage the surfaces.
- Ensure that the joints of the components of the appliance are not left as damp and with detergent. Otherwise, corrosion may occur on these joints.

Plastic parts and painted surfaces

Cleaning the accessories

Unless otherwise stated in the user manual, do not wash the product accessories in the dishwasher.

Cleaning the control panel

- When cleaning the panels with knob control, wipe the panel and knobs with a damp soft cloth and dry with a dry cloth. Do not remove the knobs and gaskets underneath to clean the control panel. The control panel and knobs may be damaged.
- While cleaning the inox panels with knob control, do not use inox cleaning agents around the knobs. The indicators around the knobs may be deleted.
- Clean the touch control panels with a damp soft cloth and dry with a dry cloth. If your product has a key lock feature, set the key lock before performing control panel cleaning. Otherwise, incorrect detection may occur on the keys.

Cleaning the inside of the oven (cooking area)

Follow the cleaning steps described in the “General cleaning information” section according to the surface types in your oven.

Cleaning the side walls of the oven

The side walls in the cooking area can only be covered with enamel or catalytic walls. It varies by model. If there is a catalytic wall, refer to the “Catalytic walls” section for information.

If your product is a side rack model, remove the side racks before cleaning your side walls. Then complete the cleaning as described in the “General cleaning information” section according to the side wall surface type.

To remove the side racks:

1. Remove the front of the side rack by pulling it on the side wall in the opposite direction.
2. Pull the side rack towards you to remove it completely.

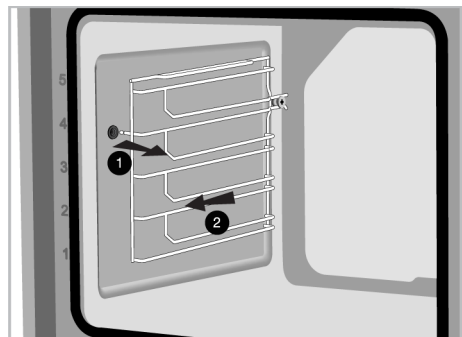

3. To reattach the shelves, the procedures applied when removing them must be repeated from the end to the beginning, respectively.

Pyrolytic self-cleaning

 Hot surfaces cause burns! Do not touch the product during self-cleaning step and keep children away from it. Keep at least 30 minutes before removing the remnants.

 Remove all accessories, telescopic shelf and side racks prior to using the Pyrolytic self-cleaning function. Failure to do so will result in damage to the accessories and side rack.

The oven is equipped with pyrolytic self-cleaning. The oven is heated to approx. 420-480 °C and existing dirt is burned to ashes. A strong smoke development may arise. Provide for good ventilation. The pyrolysis should be used after approx. every 10th oven usage.

1. **Remove all accessories from the oven. In models with side rack; do not forget to take out the side racks.**

 Failure to remove the accessories and side racks prior to using the Pyrolytic self-cleaning function will result in damage to the accessories.

2. Before the cleaning cycle, remove dirt from exterior surfaces and oven interior with a damp cloth.

 Do not clean the door gasket. Fibre glass gasket is highly sensitive and can get damaged easily. In case of a damage on the oven door gasket, replace with the new one from the Authorised Service.

3. Turn on the oven by touching the  key.

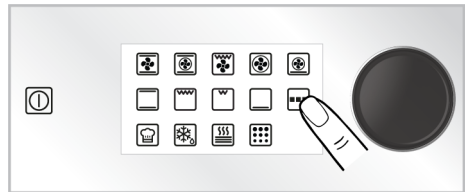

4. Touch on the “Extra function activation” on function display.

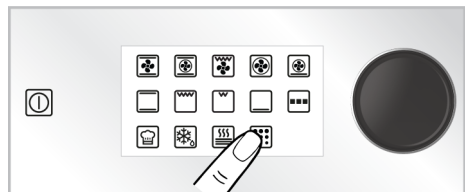





5. Touch on the “Pyrolysis” function on the lower row of function display.

6. The “HI” pyrolytic level and “02:00” time appears on the display.

7. Touch the  key to start cleaning.

» Self-cleaning starts and the self-cleaning time appears on the display. This duration cannot be changed.



8. When the oven reaches a certain temperature after the self-cleaning process starts, the lock symbol  appears on the time display and oven door cannot be opened. It remains locked for a while after the pyrolysis function ends. Do not force the door lock with handle until lock symbol disappears.
9. When the cleaning process is finished, “End” appears on the display. If the  key is touched, the oven will switch off.
10. After the display shows “End”, turn the oven off by touching the  key.
11. After the symbol  disappears on the display, remove soil deposits with vinegar water.

For Eco pyrolytic self-cleaning mode:

 Hot surfaces cause burns! Do not touch the product during self cleaning step and keep children away from it. Keep at least 30 minutes before removing the remnants.

 Remove all accessories, telescopic shelf and side racks prior to using the Pyrolytic self-cleaning function. Failure to do so will result in damage to the accessories and side rack.

If your oven is not very dirty, we recommend you to use the “Pyrolysis - economy mode” function. “Pyrolysis - economy mode” function is shorter than “Pyrolysis function. If the oven is very dirty, the “Pyrolysis - economy mode” function may not be sufficient. In this case, select the “Pyrolysis” function.

1. **Remove all accessories from the oven. In models with side rack; do not forget to take out the side racks.**

 Failure to remove the accessories and side racks prior to using the Pyrolytic self-cleaning function will result in damage to the accessories.

2. Before the cleaning cycle, remove dirt from exterior surfaces and oven interior with a damp cloth.
3. Turn on the oven by touching the  key.
4. Touch on the “Extra function activation” on function display.

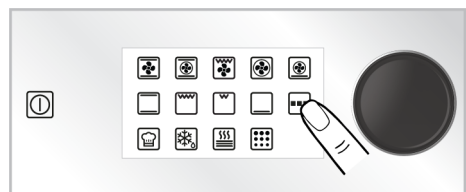

5. Touch on the “Pyrolysis” function on the lower row of function display.

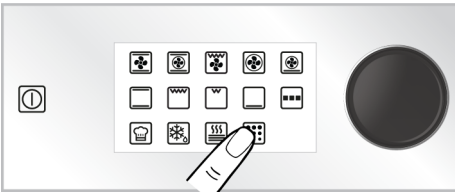

6. Touch and on the “Pyrolysis” function again.





- » The 3-2-1 count down is displayed. When the countdown expires, the Eco pyrolytic self-cleaning mode is activated.

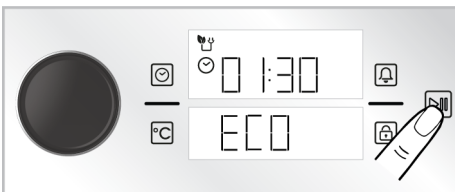

7. Touch the  key to start the Eco pyrolytic cleaning.

- » Self-cleaning starts and the self-cleaning time appears on the display. This duration cannot be changed.



8. When the oven reaches a certain temperature after the self-cleaning process starts, the lock symbol  appears on the time display and oven door cannot be opened. It remains locked for a while after the pyrolysis function ends. Do not force the door lock with handle until lock symbol disappears.
9. When the cleaning process is finished, “End” appears on the display. If the  key is touched, the oven will switch off.
10. After the display shows “End”, turn the oven off by touching the  key.
11. After the symbol  disappears on the display, remove soil deposits with vinegar water.

Cleaning the oven door

i Do not use harsh abrasive cleaners, metal scrapers, wire wool or bleach materials to clean the oven door and glass.

You can remove your oven door and door glasses to clean them. How to remove the doors and windows is explained in the sections "Removing the oven door" and "Removing the inner glasses of the door". After removing the door inner glasses, clean them using a dishwashing detergent, warm water and a soft cloth or sponge and dry them with a dry cloth. Wipe the glass with vinegar and then rinse it against lime residues that may occur on the oven glass.

Removing the oven door

1. Open the oven door.
2. Open the clips in the front door hinge socket on the right and left by pressing downwards as shown in the figure.

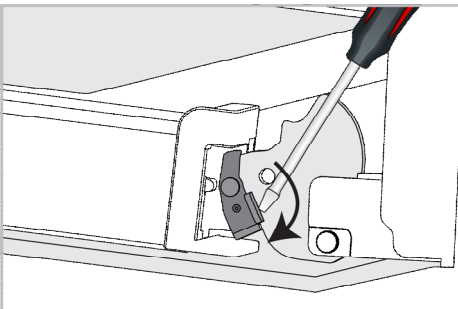

Hinge lock - closed position

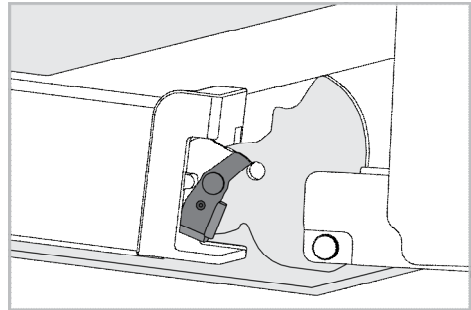

Hinge lock - open position

3. Get the oven door to a half-open position.

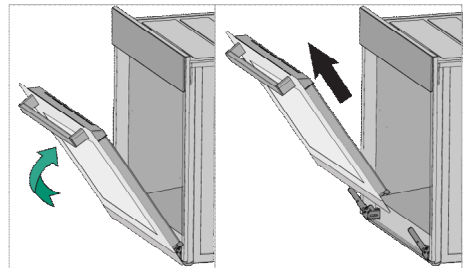

4. Pull the removed door upwards to release it from the right and left hinges and remove it.

i To reattach the door, the procedures applied when removing it must be repeated from the end to the beginning, respectively. When installing the door, be sure to close the clips on the hinge socket.

Removing the inner glass of the oven door

Inner glass of the product's front door of may be removed for cleaning.

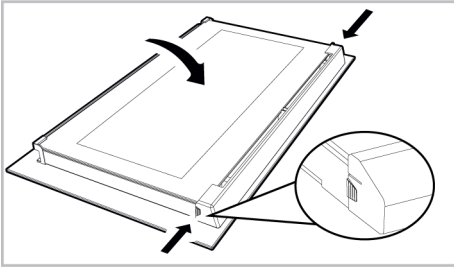

1. Open the oven door.
2. Pull the plastic component, attached on the upper section of the front door, towards yourself by simultaneously pressing on the pressure points on both sides of the component and remove it.

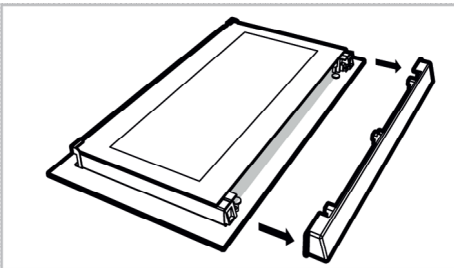

3. As shown in the figure, gently lift the innermost glass towards 'A' and then, remove it by pulling towards 'B'.

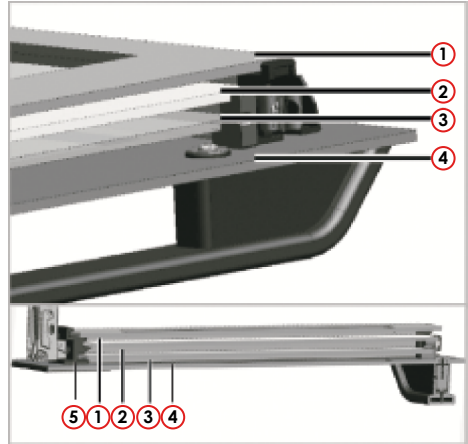

- ① Innermost glass
- ② Second inner glass
- ③ Third inner glass
- ④ Outer glass
- ⑤ Plastic glass slot-Lower

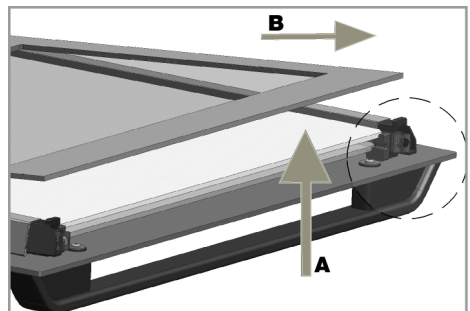

4. Repeat the same process for removing the second and third glasses.

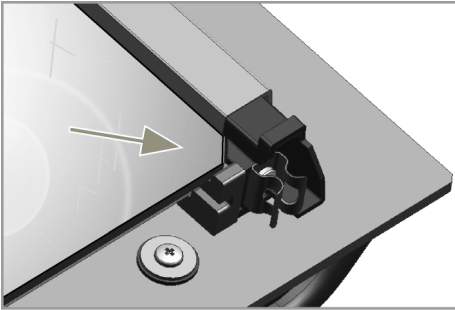

The first step of regrouping the door is to replace the second and third glasses (2, 3).

As shown in the figure, place the bevelled edge of the glass to meet the bevelled edge of the plastic slot.

The attachment order of the second and third inner glasses is not important, as they are interchangeable.

While attaching the innermost glass (1), pay attention to place the printed side of the glass on the second inner glass.

It is crucial to place the lower corners of all inner glasses to meet the lower plastic slots (5).

Push the plastic component towards the frame until a “click” sound is heard.

i After cleaning, all glasses must be reassembled.

Cleaning the oven lamp

In the event that the glass door of the oven lamp in the cooking area becomes dirty; clean using dishwashing detergent, warm water and a soft cloth or sponge and dry with a dry cloth. In case of oven lamp failure, you can replace the oven lamp by following the sections that follow.

Replacing the oven lamp

General warnings

- To avoid the risk of electric shock before replacing the oven lamp, disconnect the electrical connector and wait for the oven to cool. Hot surfaces may cause burns!
- In this oven, an incandescent lamp with a power of less than 40 W, a height of less than 60mm, a diameter of less than 30mm or a halogen lamp with socket type G9, a power of less than 60 W is used. The lamps are suitable for operation at temperatures above 300°C. Oven lamps can be obtained from Authorised Service Agents or a technician with licence (See Technical Specifications).
- The position of the lamp may differ from that is shown in the figure.
- The lamp used in this product is not suitable for use in the lighting of home rooms. The purpose of this lamp is to help the user see food products.

- The lamps used in this product must withstand extreme physical conditions such as temperatures above 50°C.

If your oven has a round lamp;

1. Disconnect the product from the electricity.
2. Remove the glass cover by turning it counterclockwise.

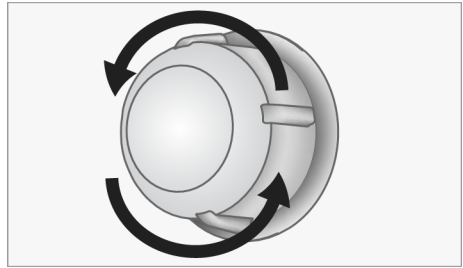

3. If your oven lamp is type **A** shown in the figure below, rotate the oven lamp as shown in the figure and replace it with a new one. If type **B** is a model, pull it out as shown in the figure and replace it with a new one.

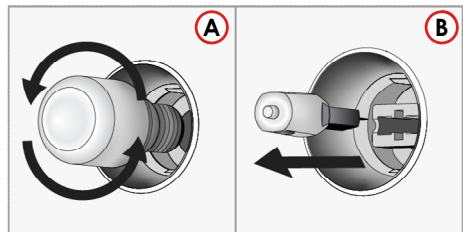

4. Refit the glass cover.

8. Troubleshooting

Consult the Authorised Service Agent or technician with license or the dealer where you have purchased the product if you cannot remedy the trouble although you have implemented the instructions in this section. Never attempt to repair a defective product yourself.

Oven emits steam when it is in use

- It is normal that steam escapes during operation. » *This is not a fault.*

Water drops occur during cooking

- The vapour that arises during cooking can condense and form water droplets when it hits cold surfaces of the product. » *This is not a fault.*

Product emits metal noises while heating and cooling

- The vapour that arises during cooking can condense and form water droplets when it hits cold surfaces of the product. » *This is not a fault.*

Product does not operate

- The mains fuse is defective or has tripped. » *Check fuses in the fuse box. If necessary, replace or reset them.*
- Product is not wired into the (grounded) socket. » *Check the electrical connection.*
- Buttons/knobs/keys on the control panel do not function. » *If your product equipped with key lock function, key lock may be enabled. Please disable it.*

Oven light does not work

- Oven lamp is defective. » *Replace oven lamp.*
- Power is cut. » *Check if there is power. Check the fuses in the fuse box. If necessary, replace or reset the fuses.*

Oven does not heat

- Might not be set to a certain cooking function and/or temperature. » *Set the oven to a certain cooking function and/or temperature.*
- In models equipped with a timer, the timer is not adjusted. » *Adjust the time.*
- Power is cut. » *Check if there is power. Check the fuses in the fuse box. If necessary, replace or reset the fuses.*
- The oven door might be open. » *Make sure the oven door is closed. If the oven door remains open for more than approx. 5 minutes, the cooking time settings will be cancelled and the heaters will not work.*

(In models with timer) Clock display is blinking or clock symbol is on

- A previous power outage has occurred. » *Adjust the time / Switch of the product and switch it on again.*

After the cooking has started, the symbol is constantly flashing on the display and giving an audible warning

- The oven door may be open. » *Make sure the oven door is completely closed. If the error persists, contact the authorized service.*

Error codes/reasons and possible solutions

Error codes	Error reasons	Possible solutions
Er 1 - Er 7	Communication errors	Turn off at the isolation switch for the oven, wait 10 seconds and then switch back on at the isolation switch for the oven. If the error persists, contact the service with the error code on the oven screen.
Er 8 - Er 27	Sensor errors	If your oven is too hot, turn off at the isolation switch for the oven, wait for it to cool and switch back on at the isolation switch for the oven. If the error persists, contact the service with the error code on the oven screen.
Er 32 - Er 41	Oven heating errors	If your oven is excessively hot, turn off at the isolation switch for the oven, wait for it to cool and switch back on at the isolation switch for the oven. If the error persists, contact the service with the error code on the oven screen.
Er 42 - Er 58	Oven component errors	Contact the service with the error code on the oven screen.
Er 59 - Er 64	Oven door errors	Turn off at the isolation switch for the oven, wait 10 seconds and then switch back on at the isolation switch for the oven. If the error persists, contact the service with the error code on the oven screen.
Er 72 - Er 80	Hardware errors	Contact the service with the error code on the oven screen.
Er 81 - Er 85	Oven safety errors	Contact the service with the error code on the oven screen.
Er 93 - Er 99	Electronic board and timer errors	Turn off at the isolation switch for the oven, wait 10 seconds and then switch back on at the isolation switch for the oven. If the error persists, contact the service with the error code on the oven screen.

9. Installation

If the product is to be placed under the counter: (Figure 2)

- In order to provide the necessary ventilation in the back of the kitchen furniture, openings should be created in the dimensions shown in figure 2.
- The electrical connection must be in the area **A** in figure 2 or outside the installation site.
- If the product is to be placed under a hob, follow the dimensions given in the hob installation manual.

If the product is to be placed in the tall cabinet: (Figure 3)

- In the back compartment of the kitchen furniture, openings should be created in the dimensions shown in figure 3 in order to provide the necessary ventilation. This opening should be along the height of the cabinet.
- If there is a back panel of the tall cabinet where the product will be placed, it must be removed.
- The electrical connection must be in the **A** area in figure 3 or outside the installation area.

If the product is to be placed to the corner: (Figures 4a and 4b)

- Attention should be paid to the dimensions given in order to make the corner installation in the figures 4a and 4b.

Connecting the appliance to the electricity supply

- Only connect the product to a grounded outlet/line with the voltage and protection as specified in the "Technical specifications". Have the grounding installation made by a qualified electrician while using the product with or without a transformer. Our company shall not be liable for any problems arising due to the product not being earthed in accordance with the local regulations.
- Before starting any work on the electrical installation, disconnect the product from the mains supply. There is the risk of an electric shock!
- The product must be connected to the mains supply only by an authorised and qualified person. The product's warranty period starts only after correct installation. Manufacturer shall not be held responsible for damages arising from procedures carried out by unauthorised persons.
- The appliance must be installed so that it can be completely disconnected from the mains supply. The separation must be provided by a switch built into the fixed electrical installation, according to construction regulations.

- Rear surface of the oven gets hot when it is in use. Make sure that the electrical connection does not come into contact with the rear surface otherwise, connections can get damaged.
- The connection cable must not be clamped, bent or trapped or come into contact with hot parts of the oven. You may cause the oven to short circuit and catch fire as a result of the cable melting. If the power cord is damaged, it must be replaced by a qualified electrician. Otherwise there is a risk of an electric shock, short circuit or fire!
- The plug of the power cord should be easily accessible after installation (but not over the hobs).
- When wiring, you must comply with national / local electrical regulations and use socket outlet / line and plug suitable for the Oven. If the power limits of the product exceed the current carrying capacity of the plug and socket outlet / line, you must connect the product directly to the fixed electrical installation without using the plug and socket outlet / line.
- Make sure that fuse rating is compatible with the product.
- Connection must comply with national regulations.
- The mains supply data must correspond to the data specified on the type label of

the product. Open the front door to see the type label.

- Power cable of your product must comply with the values in “Technical specifications” table.

If the product will be connected directly to the supply power:

- If it is not possible to disconnect all poles in the supply power, a disconnection unit with at least 3 mm contact clearance (fuses, line safety switches, contractors) must be connected and all the poles of this disconnection unit must be adjacent to (not above) the product in accordance with IEE directives. Failure to obey this instruction may cause operational problems and invalidate the product warranty.
- Additional protection by a residual current circuit breaker is recommended.

If the product is produced with cable and plug

- Your product is produced with mains cable and plug. Connect the plug of your product to a grounded outlet and make the electrical connection.

If the product is produced with cable and without plug

- Connect the cord of the product to supply power as identified below:

BROWN cable = **L** (Phase)

BLUE cable = **N** (Neutral)

GREEN / YELLOW cable = (**E**)

⊕ (Ground)

If the product is produced with cable and without plug

- A power cable that it is defined in the technical table home must be connected to product by following the instructions. Power cable must not be longer than 2m because of safety reasons.
- Open the terminal block cover with a screwdriver.
- Insert the power cable through the cable clamp below the terminal and secure it to the main body with the integrated screw on cable clamping component.
- Connect the cables according to the supplied diagram.

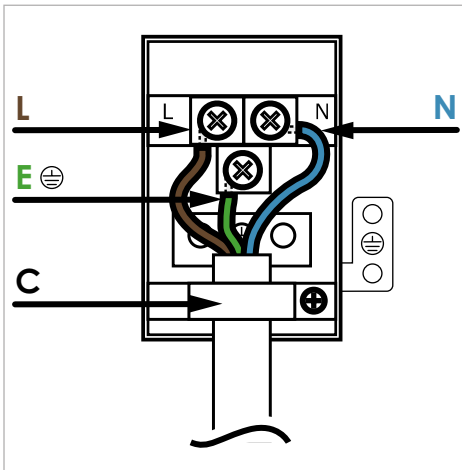

BROWN cable = **L** (Phase)

BLUE cable = **N** (Neutral)

GREEN / YELLOW cable = **(E)**

⊖ (Ground)

C = Cable clamp

- After completing the wire connections, close the terminal block cover.
- Connect the power cable to supply power by routing it so that it will not contact the product and get squeezed between the product and the wall.

Prevention against possible fire risk!

- Ensure all electrical connections are secure and tight to prevent risk of arcing.
- Do not use damaged cables or extension cables.
- Ensure liquid or moisture is not accessible to the electrical connection point.

Placing and fixing the product (Figure 5)

- Place the appliance on the furniture, centred with two or more people.
- Fix the product to the furniture using the screws provided as shown in figure 5.
- At the end of the installation, check that the screws are properly tightened and that the product is firmly fixed. If the product is not installed in accordance with the instructions and the screws are not properly tightened, there is a risk of tipping during use.

Final check

- After installation, turn on the mains supply.
- Read the user manual for the first use of the product.
- Check product functions.

Removing the product

- Disconnect the product from the mains supply.
 - Unscrew the fastening screws.
- Lift the product lightly with two or more people and take it out completely.

Warning symbols

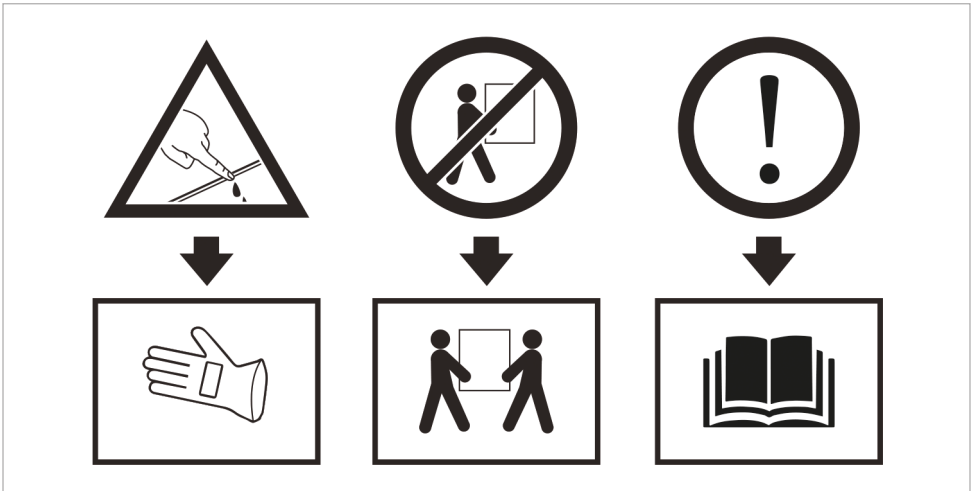

Tools required

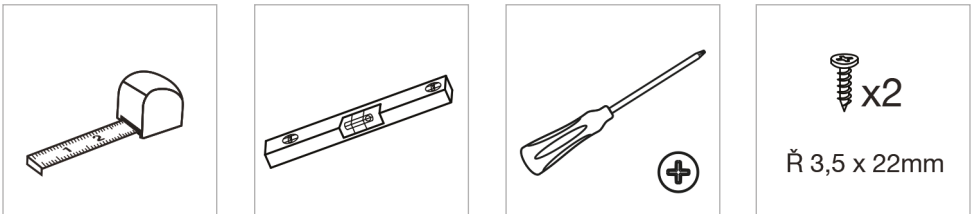

Figure 1

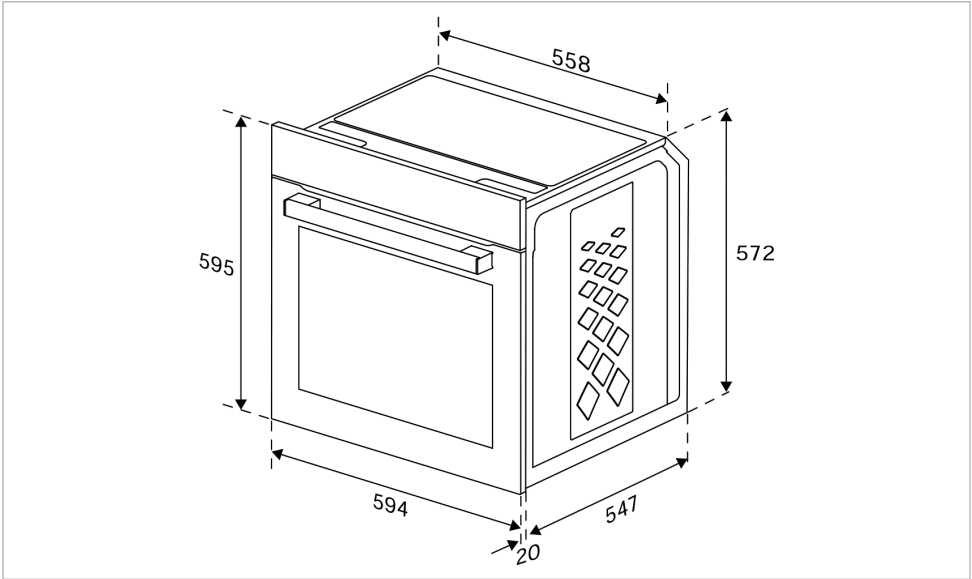
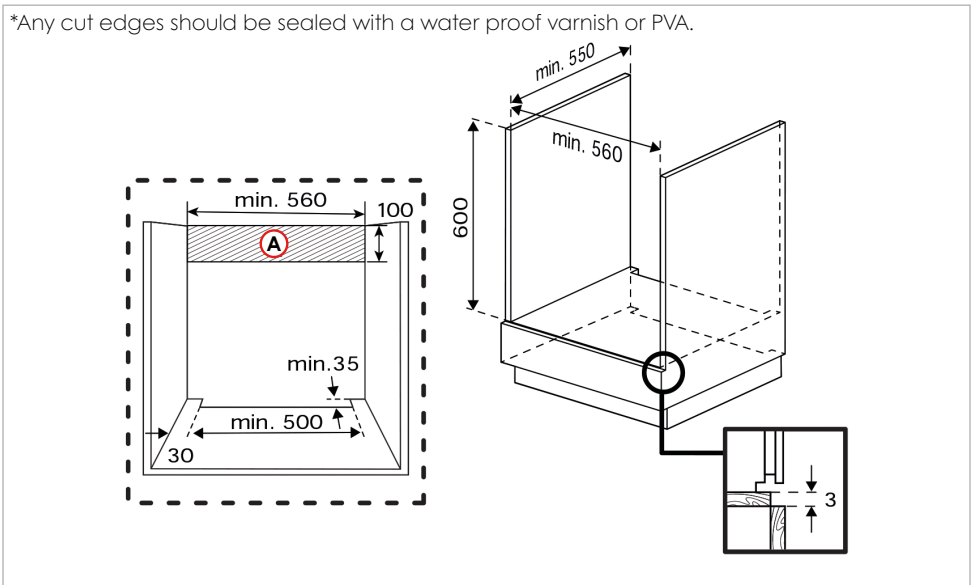

Figure 2

*Any cut edges should be sealed with a water proof varnish or PVA.



All installation dimensions shown are in millimetres.

Figure 3

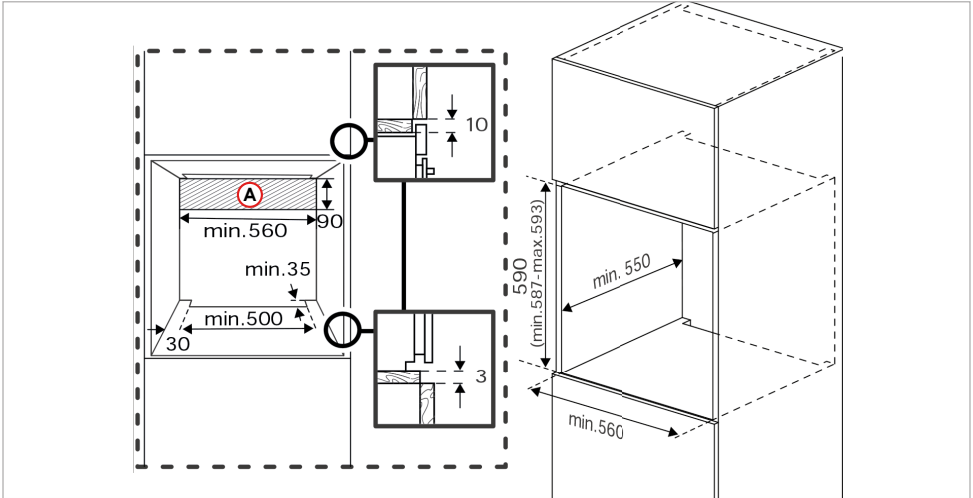

Figure 4a

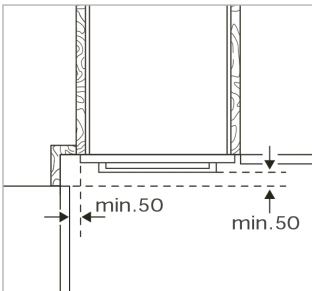

Figure 4b

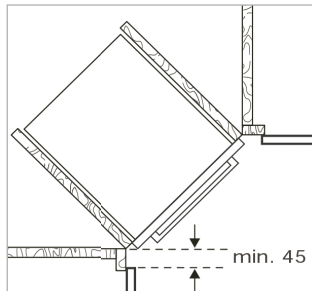
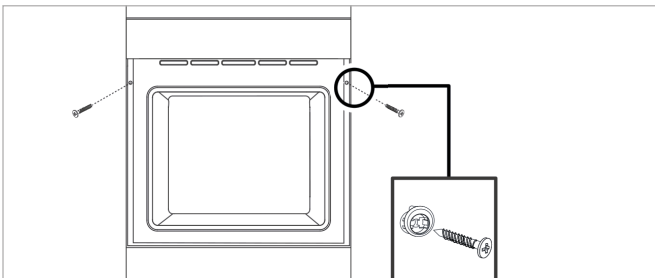

Figure 5



10. Your guarantee

Product Guarantee Details (UK and Republic of Ireland only)

Your appliance has the benefit of a comprehensive manufacturer's guarantee which covers the cost of breakdown repairs. (Details of which are shown on your Proof of Purchase Document).

- Any claim during the period of the guarantee **MUST BE ACCOMPANIED BY THE PROOF OF PURCHASE.**
- The product must be correctly installed and operated in accordance with the manufacturer's instructions and used for normal domestic purposes.
- This guarantee does not cover accidental damage, misuse or alterations which are likely to affect the product.
- The guarantee is invalid if the product is tampered with, or repaired by any unauthorised person. *(The guarantee in no way affects your statutory or legal rights).*

What to do if you need to report a problem

Please ensure you have ready:

- The product's model and serial numbers.
- Howdens Proof of Purchase Document.
- Your full contact details.

Call the Depot number on your Proof of Purchase Document supplied with the product/kitchen.

or

Call the LAMONA Service Line on:

Within the UK: 0344 460 0006

Within Republic of Ireland: 01525 5703

- Product installed within a domestic kitchen or a non-domestic kitchen where 8 or fewer people are using the appliance.

Where to find model and serial number on your appliance.	Open door on panel just below door seal.
--	--

Spare Parts availability – 10 years

Only fit Genuine Spare Parts

www.lamonaspares.co.uk (UK only)

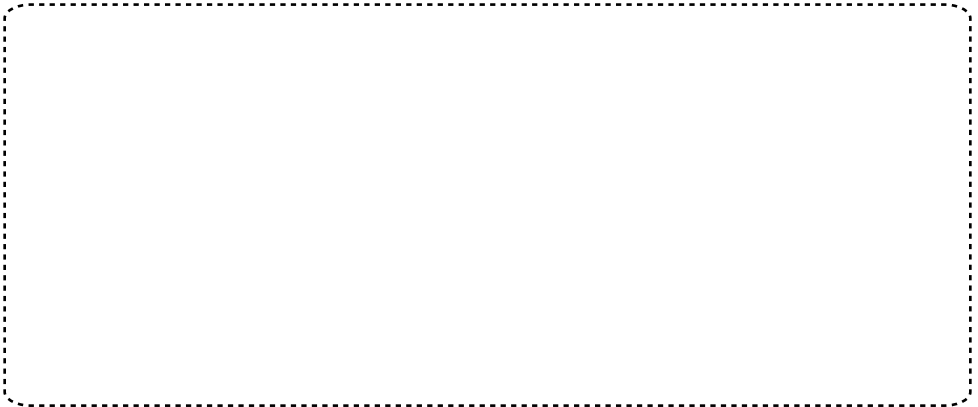

Product serial number
(Place sticker here)

LAMONA

at the heart of the kitchen



FR

Cet appareil
se recycle

REPRISE
À LA LIVRAISON



OU

À DÉPOSER
EN MAGASIN



OU

À DÉPOSER
EN DÉCHÈTERIE



Points de collecte sur www.quefairedemesdechets.fr
Privilégiez la réparation ou le don de votre appareil!

Howden Joinery Ltd, Thorpe Road, Howden, East Yorkshire, DN14 7PA

Imported in EU by: Houdan Cuisines SAS, Z.A. du Bois Rigault Nord,
1Rue Calmette, 62880 Vendin-le-Vieil, Cedex, France.

Product information correct at the time of publication in March 2022.
The company has a policy of continuous product development and
reserves the right to change any products and specifications given in
this manual. Subject to the Terms and Conditions of Trading, a copy of
the Howdens Terms and Conditions is available upon request.

Copyright © 2022 Howden Joinery Ltd. All rights reserved.