

▶ BPK948330B
BPK948330M

EN User Manual
Oven

USER MANUAL



AEG

FOR PERFECT RESULTS

Thank you for choosing this AEG product. We have created it to give you impeccable performance for many years, with innovative technologies that help make life simpler – features you might not find on ordinary appliances. Please spend a few minutes reading to get the very best from it.

Visit our website to:



Get usage advice, brochures, trouble shooter, service and repair information:
www.aeg.com/support



Register your product for better service:
www.registeraeg.com



Buy Accessories, Consumables and Original spare parts for your appliance:
www.aeg.com/shop

CUSTOMER CARE AND SERVICE

Always use original spare parts.

When contacting our Authorised Service Centre, ensure that you have the following data available: Model, PNC, Serial Number.

The information can be found on the rating plate.

 Warning / Caution-Safety information

 General information and tips

 Environmental information

Subject to change without notice.

CONTENTS

1. SAFETY INFORMATION.....	5
1.1 Children and vulnerable people safety.....	5
1.2 General Safety.....	5
2. SAFETY INSTRUCTIONS.....	7
2.1 Installation.....	7
2.2 Electrical connection.....	8
2.3 Use.....	8
2.4 Care and cleaning.....	9
2.5 Pyrolytic cleaning.....	9
2.6 Internal lighting.....	10
2.7 Service.....	10
2.8 Disposal.....	10
3. PRODUCT DESCRIPTION.....	11
3.1 General overview.....	11
3.2 Accessories.....	11
4. HOW TO TURN OVEN ON AND OFF.....	13
4.1 Control panel.....	13
4.2 Display.....	13
5. BEFORE FIRST USE.....	16
5.1 Initial Cleaning.....	16
5.2 First connection.....	16
5.3 Wireless connection.....	16
5.4 Initial preheating.....	17
6. DAILY USE.....	18
6.1 How to set: Heating functions.....	18
6.2 How to set: Assisted cooking.....	18
6.3 Heating functions.....	19
6.4 Notes on: Moist Fan Baking.....	21
7. CLOCK FUNCTIONS.....	22
7.1 Clock functions description.....	22
7.2 How to set: Clock functions.....	22
8. HOW TO USE: ACCESSORIES.....	25
8.1 Inserting accessories.....	25
8.2 Using telescopic runners.....	25
8.3 Using Trivet and Grill- / Roasting pan.....	26
8.4 Food Sensor.....	27
9. ADDITIONAL FUNCTIONS.....	30
9.1 How to save: Favourites.....	30
9.2 Automatic switch-off.....	30
9.3 Cooling fan.....	30
10. HINTS AND TIPS.....	31
10.1 Cooking recommendations.....	31
10.2 Moist Fan Baking.....	31
10.3 Moist Fan Baking - recommended accessories.....	32

CONTENTS

10.4	Cooking tables for test institutes.....	32
11.	CARE AND CLEANING.....	35
11.1	Notes on cleaning.....	35
11.2	How to remove: Shelf supports	35
11.3	How to use: Pyrolytic cleaning.....	36
11.4	Cleaning Reminder.....	37
11.5	How to remove and install: Door.....	37
11.6	How to replace: Lamp.....	38
12.	TROUBLESHOOTING.....	40
12.1	What to do if.....	40
12.2	How to manage: Error codes.....	41
12.3	Service data.....	42
13.	ENERGY EFFICIENCY.....	43
13.1	Product Information and Product Information Sheet*	43
13.2	Energy saving.....	43
14.	MENU STRUCTURE.....	45
14.1	Menu.....	45
14.2	Submenu for: Cleaning.....	45
14.3	Submenu for: Options.....	45
14.4	Submenu for: Connections.....	46
14.5	Submenu for: Setup.....	46
14.6	Submenu for: Service.....	47
15.	IT'S EASY!.....	48
16.	TAKE A SHORTCUT!.....	50

1. ⚠ SAFETY INFORMATION

Before the installation and use of the appliance, carefully read the supplied instructions. The manufacturer is not responsible for any injuries or damage that are the result of incorrect installation or usage. Always keep the instructions in a safe and accessible location for future reference.

1.1 Children and vulnerable people safety

- This appliance can be used by children aged from 8 years and above and persons with reduced physical, sensory or mental capabilities or lack of experience and knowledge if they have been given supervision or instruction concerning the use of the appliance in a safe way and understand the hazards involved. Children of less than 8 years of age and persons with very extensive and complex disabilities shall be kept away from the appliance unless continuously supervised.
- Do not let children play with the appliance and mobile devices with My AEG Kitchen.
- Keep all packaging away from children and dispose of it appropriately.
- **WARNING:** Keep children and pets away from the appliance when it operates or when it cools down. Accessible parts become hot during use.
- If the appliance has a child safety device, it should be activated.
- Children shall not carry out cleaning and user maintenance of the appliance without supervision.

1.2 General Safety

- Only a qualified person must install this appliance and replace the cable.
- **WARNING:** The appliance and its accessible parts become hot during use. Care should be taken to avoid touching heating elements.

SAFETY INFORMATION

- Always use oven gloves to remove or put in accessories or ovenware.
- Before carrying out any maintenance, disconnect the appliance from the power supply.
- **WARNING:** Ensure that the appliance is switched off before replacing the lamp to avoid the possibility of electric shock.
- Do not use the appliance before installing it in the built-in structure.
- Do not use a steam cleaner to clean the appliance.
- Do not use harsh abrasive cleaners or sharp metal scrapers to clean the glass door since they can scratch the surface, which may result in shattering of the glass.
- If the mains power supply cable is damaged, it must be replaced by the manufacturer, its Authorised Service Centre or similarly qualified persons to avoid an electrical hazard.
- Excessive spillage must be removed before the pyrolytic cleaning. Remove all parts from the oven.
- To remove the shelf supports first pull the front of the shelf support and then the rear end away from the side walls. Install the shelf supports in the opposite sequence.
- The means for disconnection must be incorporated in the fixed wiring in accordance with the wiring rules.
- Use only the food sensor (core temperature sensor) recommended for this appliance.

2. SAFETY INSTRUCTIONS

2.1 Installation

 **WARNING!**

Only a qualified person must install this appliance.

- Remove all the packaging.
- Do not install or use a damaged appliance.
- Follow the installation instructions supplied with the appliance.
- Always take care when moving the appliance as it is heavy. Always use safety gloves and enclosed footwear.
- Do not pull the appliance by the handle.
- Install the appliance in a safe and suitable place that meets installation requirements.
- Keep the minimum distance from other appliances and units.
- Before mounting the appliance, check if the oven door opens without restraint.
- The appliance is equipped with an electric cooling system. It must be operated with the electric power supply.
- The built-in unit must meet the stability requirements of DIN 68930.

Cabinet minimum height (Cabinet under the work-top minimum height)	578 (600) mm
Cabinet width	560 mm
Cabinet depth	550 (550) mm
Height of the front of the appliance	594 mm
Height of the back of the appliance	576 mm
Width of the front of the appliance	595 mm
Width of the back of the appliance	559 mm
Depth of the appliance	567 mm
Built in depth of the appliance	546 mm
Depth with open door	1027 mm
Ventilation opening minimum size. Opening placed on the bottom rear side	560 x 20 mm
Mounting screws	4 x 25 mm

SAFETY INSTRUCTIONS

2.2 Electrical connection

 **WARNING!**

Risk of fire and electric shock.

- All electrical connections should be made by a qualified electrician.
- The appliance must be earthed.
- Make sure that the parameters on the rating plate are compatible with the electrical ratings of the mains power supply.
- Always use a correctly installed shockproof socket.
- Do not use multi-plug adapters and extension cables.
- Make sure not to cause damage to the mains plug and to the mains cable. Should the mains cable need to be replaced, this must be carried out by our Authorised Service Centre.
- Do not let mains cables touch or come near the appliance door or the niche below the appliance, especially when it operates or the door is hot.
- The shock protection of live and insulated parts must be fastened in such a way that it cannot be removed without tools.
- Connect the mains plug to the mains socket only at the end of the installation. Make sure that there is access to the mains plug after the installation.
- If the mains socket is loose, do not connect the mains plug.
- Do not pull the mains cable to disconnect the appliance. Always pull the mains plug.
- Use only correct isolation devices: line protecting cut-outs, fuses (screw type fuses removed from the holder), earth leakage trips and contactors.
- The electrical installation must have an isolation device which lets you disconnect the appliance from the mains at all poles. The isolation device must have a contact opening width of minimum 3 mm.
- Fully close the appliance door before you connect the mains plug to the mains socket.
- This appliance is supplied without a main plug and a main cable.

2.3 Use

 **WARNING!**

Risk of injury, burns and electric shock or explosion.

- This appliance is for household use only.
- Do not change the specification of this appliance.
- Make sure that the ventilation openings are not blocked.
- Do not let the appliance stay unattended during operation.
- Deactivate the appliance after each use.
- Be careful when you open the appliance door while the appliance is in operation. Hot air can release.
- Do not operate the appliance with wet hands or when it has contact with water.
- Do not apply pressure on the open door.
- Do not use the appliance as a work surface or as a storage surface.
- Open the appliance door carefully. The use of ingredients with alcohol can cause a mixture of alcohol and air.
- Do not let sparks or open flames to come in contact with the appliance when you open the door.

- Do not put flammable products or items that are wet with flammable products in, near or on the appliance.
- Do not share your Wi-Fi password.

 **WARNING!**

Risk of damage to the appliance.

- To prevent damage or discoloration to the enamel:
 - do not put ovenware or other objects in the appliance directly on the bottom.
 - do not put aluminium foil directly on the bottom of cavity of the appliance.
 - do not put water directly into the hot appliance.
 - do not keep moist dishes and food in the appliance after you finish the cooking.
 - be careful when you remove or install the accessories.
- Discoloration of the enamel or stainless steel has no effect on the performance of the appliance.
- Use a deep pan for moist cakes. Fruit juices cause stains that can be permanent.
- This appliance is for cooking purposes only. It must not be used for other purposes, for example room heating.
- Always cook with the oven door closed.
- If the appliance is installed behind a furniture panel (e.g. a door) make sure the door is never closed when the appliance operates. Heat and moisture can build up behind a closed furniture panel and cause subsequent damage to the appliance, the housing unit or the floor. Do not close the furniture panel until the appliance has cooled down completely after use.

2.4 Care and cleaning

 **WARNING!**

Risk of injury, fire, or damage to the appliance.

- Before maintenance, deactivate the appliance and disconnect the mains plug from the mains socket.
- Make sure the appliance is cold. There is the risk that the glass panels can break.
- Replace immediately the door glass panels when they are damaged. Contact the Authorised Service Centre.
- Be careful when you remove the door from the appliance. The door is heavy!
- Clean regularly the appliance to prevent the deterioration of the surface material.
- Clean the appliance with a moist soft cloth. Use only neutral detergents. Do not use abrasive products, abrasive cleaning pads, solvents or metal objects.
- If you use an oven spray, follow the safety instructions on its packaging.

2.5 Pyrolytic cleaning

 **WARNING!**

Risk of Injury / Fires / Chemical Emissions (Fumes) in Pyrolytic Mode.

- Before carrying out a Pyrolytic self-cleaning function or the First Use please remove from the oven cavity:
 - any excess food residues, oil or grease spills / deposits.
 - any removable objects (including shelves, side rails etc., provided with the product) particularly any non-stick pots, pans, trays, utensils etc.
- Read carefully all the instructions for Pyrolytic cleaning.

SAFETY INSTRUCTIONS

- Keep children away from the appliance while the Pyrolytic cleaning operates. The appliance becomes very hot and hot air is released from the front cooling vents.
- Pyrolytic cleaning is a high temperature operation that can release fumes from cooking residues and construction materials, as such consumers are strongly advised to:
 - provide good ventilation during and after each Pyrolytic cleaning.
 - provide good ventilation during and after the first use at maximum temperature operation.
- Unlike all humans, some birds and reptiles can be extremely sensitive to potential fumes emitted during the cleaning process of all Pyrolytic Ovens.
 - Remove any pets (especially birds) from the vicinity of the appliance location during and after the Pyrolytic cleaning and first use maximum temperature operation to a well ventilated area.
- Small pets can also be highly sensitive to the localized temperature changes in the vicinity of all Pyrolytic Ovens when the Pyrolytic self cleaning program is in operation.
- Non-stick surfaces on pots, pans, trays, utensils etc., can be damaged by the high temperature Pyrolytic cleaning operation of all Pyrolytic Ovens and can be also a source for low level harmful fumes.
- Fumes released from all Pyrolytic Ovens / Cooking Residues as described are not harmful to humans, including children, or persons with medical conditions.

2.6 Internal lighting

WARNING!

Risk of electric shock.

- Concerning the lamp(s) inside this product and spare part lamps sold separately: These lamps are intended to withstand extreme physical conditions in household appliances, such as temperature, vibration, humidity, or are intended to signal information about the operational status of the appliance. They are not intended to be used in other applications and are not suitable for household room illumination.
- Use only lamps with the same specifications.

2.7 Service

- To repair the appliance contact the Authorised Service Centre.
- Use original spare parts only.

2.8 Disposal

WARNING!

Risk of injury or suffocation.

- Disconnect the appliance from the mains supply.
- Cut off the mains electrical cable close to the appliance and dispose of it.
- Remove the door catch to prevent children or pets from becoming trapped in the appliance.

3. PRODUCT DESCRIPTION

3.1 General overview

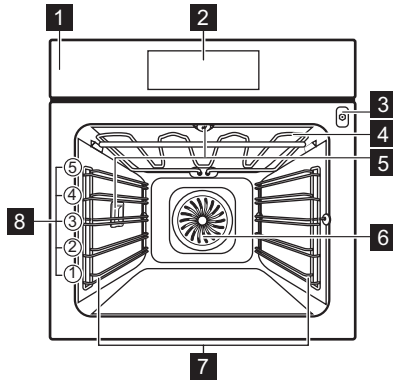

- 1** Control panel
- 2** Display
- 3** Socket for the food sensor
- 4** Heating element
- 5** Lamp
- 6** Fan
- 7** Shelf support, removable
- 8** Shelf positions

3.2 Accessories

Wire shelf

For cookware, cake tins, roasts.

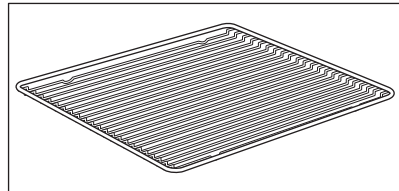

Grill- / Roasting pan

To bake and roast or as a pan to collect fat.

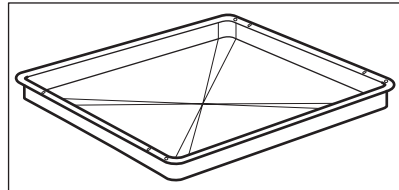

Trivet

For roasting and grilling.

Use the trivet only with the Grill- / Roasting pan.

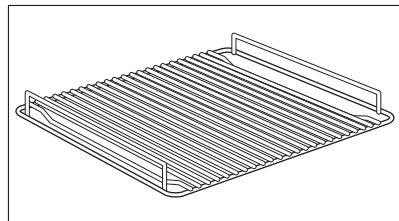

PRODUCT DESCRIPTION

Food sensor

To measure the temperature inside food.

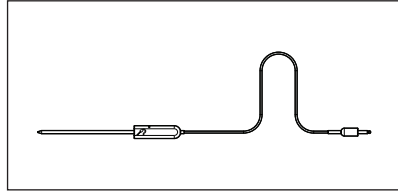

Telescopic runners

For inserting and removing trays and wireshelf more easily.

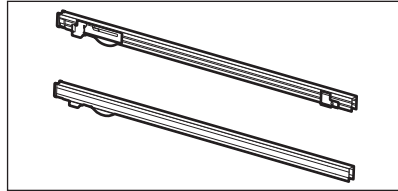

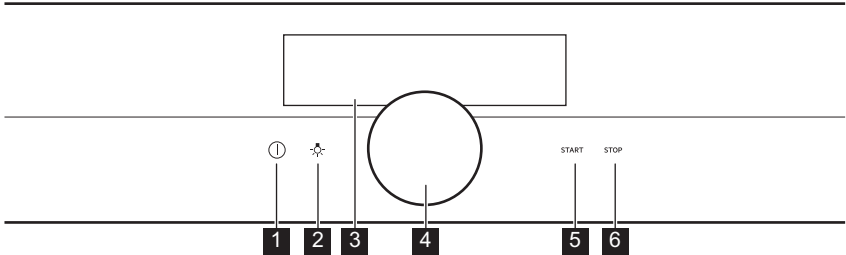

4. HOW TO TURN OVEN ON AND OFF

4.1 Control panel



1	On / Off	Press and hold to turn the oven on and off.
2	Lamp switch	To turn the lamp on and off.
3	Display	Shows the current settings of the oven.
4	Rotary knob	To operate the oven.
5	START	To turn on the selected function.
6	STOP	To turn off the selected function.





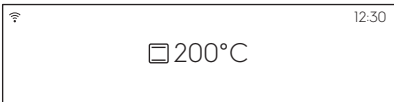

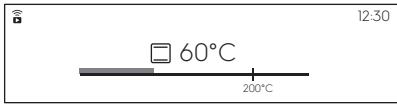
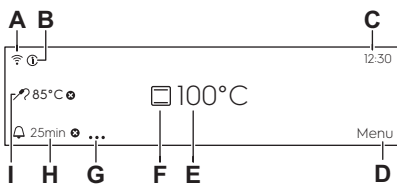

		
Hold	Press	Hold and turn
Turn on the main screen.	Confirm a setting or enter the selected submenu.	Adjust settings and navigate through the menu.

4.2 Display

	After turning on, the display shows the main screen with the heating function and the default temperature.
-------------------------------------------------------------------------------------	------------------------------------------------------------------------------------------------------------

HOW TO TURN OVEN ON AND OFF

	<p>If you do not use the oven for 2 minutes, the display goes to standby.</p>
	<p>When you cook, the display shows the set functions and other available options.</p>
	<p>The display with the maximum number of functions set.</p> <ul style="list-style-type: none"> A. Wi-Fi (selected models only) B. Information C. Time of day D. Menu E. Temperature F. Heating functions G. Timer options H. Timer I. Food sensor (selected models only)

<h2>Display indicators</h2>				
<h3>Sound alarm function indicators - when the set time of cooking ends, the signal sounds.</h3>				
 The function is on.	 The function is on. Cooking stops automatically.	 Sound alarm is off.		
<h2>Timer indicators</h2>				
 The timer starts at a later time.	 The timer starts after closing the oven door.	 To cancel the setting.	 The timer starts when the oven reaches the set temperature.	 The timer starts when cooking starts.
<h2>Door function indicators</h2>				
 The oven door is locked.				

HOW TO TURN OVEN ON AND OFF

Wi-Fi indicator - the oven can be connected to Wi-Fi.





Wi-Fi connection is turned on.

5. BEFORE FIRST USE

WARNING!

Refer to Safety chapters.

5.1 Initial Cleaning

		
Step 1	Step 2	Step 3
Remove all accessories and removable shelf supports from the oven.	Clean the oven and the accessories with a soft cloth, warm water and a mild detergent.	Place the accessories and the removable shelf supports in the oven.

5.2 First connection

The display shows welcome message after the first connection.

You have to set: Language, Display brightness, Buzzer volume, Time of day, Wireless connection.

5.3 Wireless connection

To connect the oven you need:

- Wireless network with the Internet connection.
- Mobile device connected to your wireless network.

Download the Mobile App and follow the instructions for the next steps.



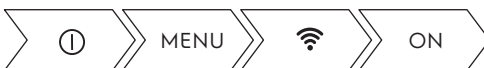

Step 1	Turn on the oven.
Step 2	Select: Menu / Settings / Connections.
Step 3	Select: Wi-Fi. Press the knob.
Step 4	Choose wireless network with the Internet connection. The oven wireless module starts within 90 sec.

Take a shortcut!



Frequency	2.4 GHz WLAN
	2412 - 2484 MHz
Protocol	IEEE 802.11b DSSS/802.11g/n OFDM
Max Power	EIRP < 20 dBm (100 mW)

5.4 Initial preheating

 Preheat the empty oven before the first use.	
Step 1	Remove all accessories and removable shelf supports from the oven.
Step 2	Set the maximum temperature for the function:  Let the oven operate for 1 h.
Step 3	Set the maximum temperature for the function:  Let the oven operate for 15 min.
<p> The oven can emit an odour and smoke during preheating. Make sure that the room is ventilated.</p>	

6. DAILY USE

WARNING!

Refer to Safety chapters.

6.1 How to set: Heating functions

Step 1	Turn on the oven.
Step 2	Hold the knob. The display shows the default heating functions.
Step 3	Select the symbol of the heating function and press the knob to enter the submenu.
Step 4	Select the heating function and press the knob.
Step 5	Select: °C. Press the knob. The display shows the temperature settings.
Step 6	Turn and press the knob to set: temperature .
Step 7	Press: START . Food Sensor - you can plug the sensor at any time before or during cooking.
STOP - press to turn off the heating function.	
Step 8	Turn off the oven.

Take a shortcut!



6.2 How to set: Assisted cooking

Every dish in this submenu has a recommended function and temperature. You can adjust the time and the temperature.

For some of the dishes you can also cook with:

- Weight Automatic
- Food Sensor

The degree to which a dish is cooked:

- Rare or Less
- Medium
- Well done or More

Step 1	Turn on the oven.
---------------	-------------------





Step 2	Select: Menu. Press the knob.
Step 3	Select: Assisted cooking. Press the knob.
Step 4	Choose a dish or a food type and press the knob to confirm.
Step 5	Press: START .



Take a shortcut!









6.3 Heating functions



Standard heating functions

Heating function	Application
 Grill	To grill thin pieces of food and to toast bread.
 Turbo Grilling	To roast large meat joints or poultry with bones on one shelf position. To make gratins and to brown.
 True Fan Cooking	To bake on up to three shelf positions at the same time and to dry food. Set the temperature 20 - 40 °C lower than for Conventional Cooking.
 Frozen Foods	To make convenience food (e.g., french fries, potato wedges or spring rolls) crispy.
 Conventional Cooking	To bake and roast food on one shelf position.

Heating function	Application
 Pizza Function	To bake pizza. To make intensive browning and a crispy bottom.
 Bottom Heat	To bake cakes with crispy bottom and to preserve food.

Special heating functions

Heating function	Application
 Preserving	To preserve vegetables (e.g., pickles).
 Dehydrating	To dry sliced fruit, vegetables and mushrooms.
 Plate Warming	To preheat plates for serving.
 Dough Proving	To speed up the rising of the yeast dough. It prevents dough surface from drying and keeps the dough elastic.
 Defrost	To defrost food (vegetables and fruit). The defrosting time depends on the amount and size of the frozen food.
 Au Gratin	For dishes such as lasagna or potato gratin. To make gratins and to brown.
 Slow Cooking	To prepare tender, succulent roasts.

Heating function	Application
 <p data-bbox="135 308 255 331">Keep Warm</p>	<p data-bbox="323 244 512 268">To keep food warm.</p>
 <p data-bbox="107 427 284 451">Moist Fan Baking</p>	<p data-bbox="323 363 1020 491">This function is designed to save energy during cooking. When you use this function, the temperature in the cavity may differ from the set temperature. The residual heat is used. The heating power may be reduced. For more information refer to "Daily Use" chapter, Notes on: Moist Fan Baking.</p>
 <p data-bbox="126 587 265 611">Bread Baking</p>	<p data-bbox="323 523 1001 571">Use this function to prepare bread and bread rolls with a very good professional-like result in terms of crispiness, colour and crust gloss.</p>

6.4 Notes on: Moist Fan Baking

This function was used to comply with the energy efficiency class and ecodesign requirements according to EU 65/2014 and EU 66/2014. Tests according to EN 60350-1.

The oven door should be closed during cooking so that the function is not interrupted and the oven operates with the highest energy efficiency possible.





When you use this function the lamp automatically turns off after 30 sec.

For the cooking instructions refer to "Hints and tips" chapter, Moist Fan Baking. For general energy saving recommendations refer to "Energy Efficiency" chapter, Energy Saving.

7. CLOCK FUNCTIONS

7.1 Clock functions description

Clock function	Application
Cooking time	To set the length of cooking. Maximum is 23 h 59 min.
Start criteria	To set when the timer starts counting.
End action	To set what happens when the timer ends counting.
Delayed start	To postpone the start and / or end of cooking.
Time extension	To extend cooking time.
Reminder	To set a countdown. Maximum is 23 h 59 min. This function has no effect on the operation of the oven.

Start criteria	Comment
-	The timer starts when you turn it on.
	The timer starts after closing the door.
	The timer starts when cooking starts.
	The timer starts when the oven reaches the set temperature.
	The timer starts at a specific time.

7.2 How to set: Clock functions

How to set the clock	
Step 1	Select: Time of day. Press the knob.
Step 2	Turn the knob to set the clock. Press the knob.

How to set cooking time	
Step 1	Select a heating function and set the temperature.

How to set cooking time	
Step 2	Select: Timer.
Step 3	Turn the knob to set the time. Press the knob.
Step 4	Select: End action. Press the knob. Timer starts counting down immediately.

Take a shortcut!



How to choose cooking start / end option	
Step 1	Choose a heating function and set the temperature.
Step 2	Select: ● ● ● . Press the knob.
Step 3	Select: Start criteria. Press the knob.
Step 4	Select: End action. Press the knob.

How to delay start and end of cooking	
Step 1	Select: ● ● ● . Press the knob.
Step 2	Select: Start criteria / At a later time. Press the knob.
Step 3	Turn the knob to set the start time. Press the knob.
Step 4	Turn the knob to set the end of cooking. Press the knob.
Step 5	Select: End action. Press the knob.

How to delay start without setting the end of cooking	
Step 1	Select: ● ● ● . Press the knob.

CLOCK FUNCTIONS

How to delay start without setting the end of cooking

Step 2	Select: Start criteria / At a later time.
Step 3	Turn the knob to set the start time. Press the knob twice to confirm.

How to extend cooking time

When 10% of cooking time is left and the food seems not to be ready, you can extend cooking time. You can also change the oven function.

Step 1	Select: Timer.
Step 2	Select preferred time icon to extend cooking time and press the knob to confirm.
Step 3	Also, you can select the preferred heating function and press the knob to change it.

8. HOW TO USE: ACCESSORIES

8.1 Inserting accessories

A small indentation at the top increases safety. The indentations are also anti-tip devices. The high rim around the shelf prevents cookware from slipping off the shelf.

Wire shelf:

Push the shelf between the guide bars of the shelf support.

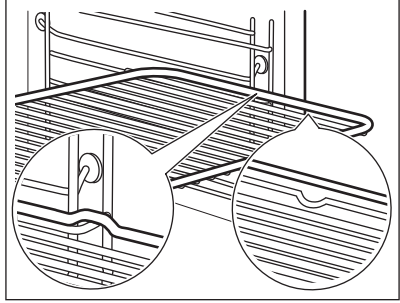

Deep pan:

Push the tray between the guide bars of the shelf support.

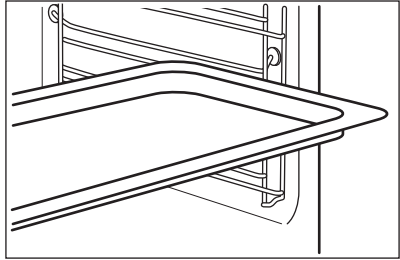

Wire shelf, Deep pan:

Push the tray between the guide bars of the shelf support and the wire shelf on the guide bars above.

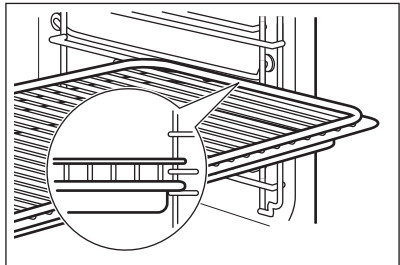

8.2 Using telescopic runners

Do not oil the telescopic runners.

Make sure you push back the telescopic runners fully in the oven before you close the oven door.

HOW TO USE: ACCESSORIES

Wire shelf:

Put the wire shelf on the telescopic runners.

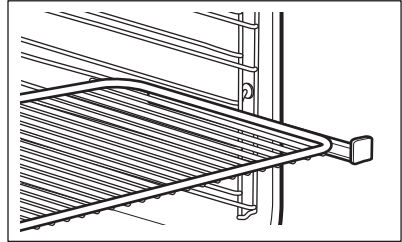

Deep pan:

Put the deep pan on the telescopic runners.

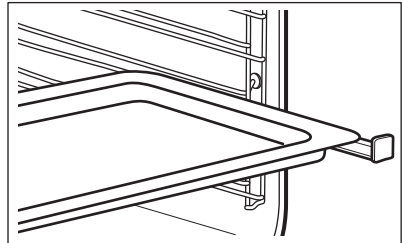

Wire shelf and deep pan together:

Place the wire shelf and the deep pan together on the telescopic runner.

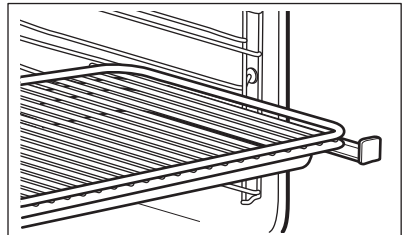

8.3 Using Trivet and Grill- / Roasting pan

WARNING!

Be careful when you remove the accessories from a hot oven. There is a risk of burns.

You can use the trivet to roast larger pieces of meat or poultry on one shelf position.

HOW TO USE: ACCESSORIES

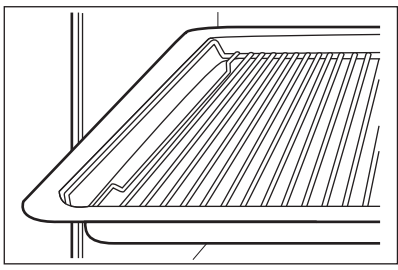
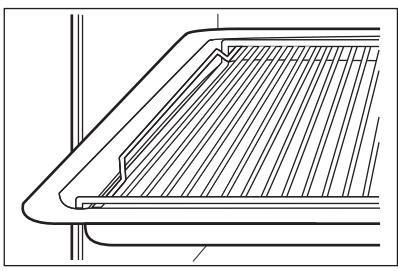
<p>Step 1</p>	<p>Put the trivet into the deep pan so that the supports of the wire shelf point up.</p>	
<p>Step 2 Put the deep pan into the oven on the necessary shelf position.</p>		
<p>You can use the trivet to grill flat dishes in large quantities and to toast.</p>		
<p>Step 1</p>	<p>Put the trivet into the deep pan so that the supports of the wire shelf point down.</p>	
<p>Step 2 Put the deep pan into the oven on the necessary shelf position.</p>		

8.4 Food Sensor

Food Sensor- measures the temperature inside the food. You can use it with every heating function.



<p>There are two temperatures to be set:</p>	
<p style="text-align: center;">°C</p> <p>The oven temperature: minimum 120 °C.</p>	<p style="text-align: center;"></p> <p>The core temperature.</p>

<p>For the best cooking results:</p>		
<p>Ingredients should be at room temperature.</p>	<p>Do not use it for liquid dishes.</p>	<p>During cooking it must remain in the dish.</p>

The oven calculates an approximate end of cooking time. It depends on the quantity of food, the set oven function and the temperature.

HOW TO USE: ACCESSORIES

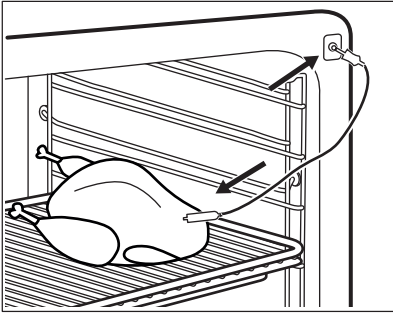
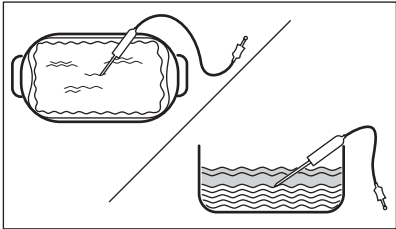
How to use: Food Sensor

Step 1	Turn on the oven.
Step 2	Set a heating function and, if necessary, the oven temperature.
Step 3	Insert: Food Sensor.
Meat, poultry and fish	Casserole
<p>Insert the tip of Food Sensor into the centre of meat, fish, in the thickest part if possible. Make sure that at least 3/4 of Food Sensor is inside of the dish.</p>	<p>Insert the tip of Food Sensor exactly in the centre of the casserole. Food Sensor should be stabilized in one place during baking. Use a solid ingredient to achieve that. Use the rim of the baking dish to support the silicone handle of Food Sensor. The tip of Food Sensor should not touch the bottom of a baking dish. Cover Food Sensor with the remaining ingredients.</p>
	
Step 4	Plug Food Sensor into the socket at the front of the oven. The display shows the current temperature of: Food Sensor.
Step 5	 - select and press the knob to set the core temperature of the sensor.
Step 6	Press the knob to set the preferred sensor option: <ul style="list-style-type: none"> • Sound alarm - when food reaches the core temperature, the signal sounds. • Sound alarm and stop cooking - when food reaches the core temperature, the signal sounds and the oven stops.
Step 7	Turn the knob to select the option. Press the knob to confirm.
Step 8	Press: START . When food reaches the set temperature, the signal sounds. You can choose to stop or to continue cooking to make sure the food is well done.

Step 9

Remove Food Sensor plug from the socket and remove the dish from the oven.

**WARNING!**

There is a risk of burns as Food Sensor becomes hot. Be careful when you unplug it and remove it from the food.

Take a shortcut!

9. ADDITIONAL FUNCTIONS

9.1 How to save: Favourites



You can save your favourite settings, such as the heating function, the cooking time, the temperature or the cleaning function. You can save 3 favourite settings.

Saved settings are available in the menu: Favourites.

Step 1	Turn on the oven.
Step 2	Select the preferred setting and press the knob.
Step 3	Select: Menu / Favourites.
Step 4	Select: Save current settings. Turn the knob to select the position of the setting.
Step 5	Press the knob to add the setting to the list of: Favourites.

9.2 Automatic switch-off

For safety reasons the oven turns off after some time, if a heating function works and you do not change any settings.

 (°C)	 (h)
30 - 115	12.5
120 - 195	8.5
200 - 245	5.5
250 - maximum	3

The Automatic switch-off does not work with the functions: Light, Food sensor, End time, Slow Cooking.

9.3 Cooling fan

When the oven operates, the cooling fan turns on automatically to keep the surfaces of the oven cool. If you turn off the oven, the cooling fan can continue to operate until the oven cools down.

10. HINTS AND TIPS

WARNING!

Refer to Safety chapters.

10.1 Cooking recommendations







The temperature and cooking times in the tables are guidelines only. They depend on the recipes and the quality and quantity of the ingredients used.

Your oven may bake or roast differently to the oven you had before. The tables below show recommended settings for temperature, cooking time and shelf position for specific types of the food. If you cannot find the settings for a special recipe, look for the similar one.





For more cooking recommendations refer to cooking tables on our website. To find the Cooking Hints check the PNC number on the rating plate on the front frame of the oven cavity.

10.2 Moist Fan Baking

For the best results follow suggestions listed in the table below.



		 (°C)		 (min)
Sweet rolls, 16 pieces	baking tray or dripping pan	180	2	25 - 35
Swiss roll	baking tray or dripping pan	180	2	15 - 25
Whole fish, 0.2 kg	baking tray or dripping pan	180	3	15 - 25
Cookies, 16 pieces	baking tray or dripping pan	180	2	20 - 30
Macaroons, 24 pieces	baking tray or dripping pan	160	2	25 - 35
Muffins, 12 pieces	baking tray or dripping pan	180	2	20 - 30
Savory pastry, 20 pieces	baking tray or dripping pan	180	2	20 - 30

HINTS AND TIPS

		 (°C)		 (min)
Short crust biscuits, 20 pieces	baking tray or dripping pan	140	2	15 - 25
Tartlets, 8 pieces	baking tray or dripping pan	180	2	15 - 25

10.3 Moist Fan Baking - recommended accessories

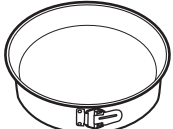





Use the dark and non-reflective tins and containers. They have better heat absorption than the light colour and reflective dishes.

			
Pizza pan	Baking dish	Ramekins	Flan base tin
Dark, non-reflective 28 cm diameter	Dark, non-reflective 26 cm diameter	Ceramic 8 cm diameter, 5 cm height	Dark, non-reflective 28 cm diameter

10.4 Cooking tables for test institutes





Information for test institutes

Tests according to: EN 60350, IEC 60350.

 BAKING ON ONE LEVEL. Baking in tins				
		 (°C)	 (min)	
Fatless sponge cake	True Fan Cooking	140 - 150	35 - 50	2
Fatless sponge cake	Conventional Cooking	160	35 - 50	2
Apple pie, 2 tins Ø20 cm	True Fan Cooking	160	60 - 90	2



BAKING ON ONE LEVEL. Baking in tins





		 (°C)	 (min)	
Apple pie, 2 tins Ø20 cm	Conventional Cooking	180	70 - 90	1



BAKING ON ONE LEVEL. Biscuits







Use the third shelf position.







		 (°C)	 (min)
Short bread / Pastry strips	True Fan Cooking	140	25 - 40
Short bread / Pastry strips, preheat the empty oven	Conventional Cooking	160	20 - 30
Small cakes, 20 per tray, preheat the empty oven	True Fan Cooking	150	20 - 35
Small cakes, 20 per tray, preheat the empty oven	Conventional Cooking	170	20 - 30









MULTILEVEL BAKING. Biscuits

		 (°C)	 (min)	
Short bread / Pastry strips	True Fan Cooking	140	25 - 45	1 / 4
Small cakes, 20 per tray, preheat the empty oven	True Fan Cooking	150	23 - 40	1 / 4

HINTS AND TIPS

 MULTILEVEL BAKING. Biscuits				
		 (°C)	 (min)	
Fatless sponge cake	True Fan Cooking	160	35 - 50	1 / 4

 GRILL				
 Preheat the empty oven for 5 minutes.				
 Grill with the maximum temperature setting.				
		 (min)		
Toast	Grill	1 - 3	5	
Beef steak, turn halfway through	Grill	24 - 30	4	

11. CARE AND CLEANING

WARNING!

Refer to Safety chapters.

11.1 Notes on cleaning

 Cleaning Agents	Clean the front of the oven with a soft cloth with warm water and a mild detergent.
	Use a cleaning solution to clean metal surfaces.
	Clean stains with a mild detergent.

 Everyday Use	Clean the cavity after each use. Fat accumulation or other residue may cause fire.
	Do not store the food in the oven for longer than 20 minutes. Dry the cavity with a soft cloth after each use.

 Accessories	Clean all accessories after each use and let them dry. Use a soft cloth with warm water and a mild detergent. Do not clean the accessories in a dishwasher.
	Do not clean the non-stick accessories using abrasive cleaner or sharp-edged objects.

11.2 How to remove: Shelf supports

Remove the shelf supports to clean the oven.

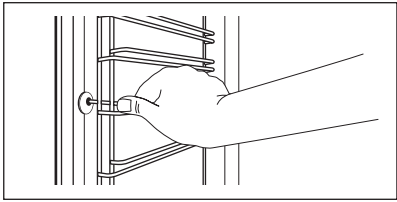
Step 1	Turn off the oven and wait until it is cold.	
Step 2	Pull the front of the shelf support away from the side wall.	

CARE AND CLEANING

Step 3	Pull the rear end of the shelf support away from the side wall and remove it.	
Step 4	Install the shelf supports in the opposite sequence. The retaining pins on the telescopic runners must point to the front.	

11.3 How to use: Pyrolytic cleaning

Clean the oven with pyrolytic cleaning.

⚠ WARNING!

There is a risk of burns.

⚠ CAUTION!

If there are other appliances installed in the same cabinet, do not use them at the same time as this function. It can cause damage to the oven.

Before the pyrolytic cleaning:

Turn off the oven and wait until it is cold.	Remove all accessories and removable shelf supports.	Clean the oven floor and the inner door glass with warm water, a soft cloth and a mild detergent.
----------------------------------------------	------------------------------------------------------	---------------------------------------------------------------------------------------------------

Step 1	Step 2	Step 3
Turn on the oven.	Select: Menu / Cleaning.	Turn the knob to select the cleaning mode. Press the knob to confirm.
Option	Cleaning mode	Duration
Quick	Light cleaning	1 h
Normal	Normal cleaning	1 h 30 min
Intense	Thorough cleaning	3 h

ⓘ When the cleaning starts, the lamp is off and the cooling fan works at a higher speed.

STOP - press to stop the cleaning before it is completed.
Do not use the oven until the door lock symbol disappears from the display.

When the cleaning ends:

Turn off the oven and wait until it is cold.	Clean the cavity with a soft cloth.	Remove the residue from the bottom of the cavity.
----------------------------------------------	-------------------------------------	---------------------------------------------------

11.4 Cleaning Reminder

When the reminder appears, cleaning is necessary.

Use the function: Pyrolytic Cleaning.

You can enable and disable the reminder in the menu: Setup.

11.5 How to remove and install: Door

You can remove the door and the internal glass panels to clean it. The number of glass panels is different for different models.

WARNING!

The door is heavy.

CAUTION!

Carefully handle the glass, especially around the edges of the front panel. The glass can break.

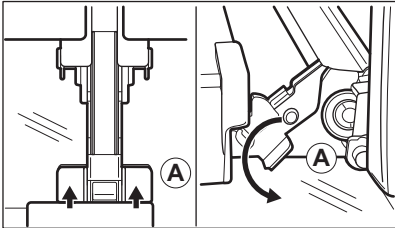
Step 1	Fully open the door.	
Step 2	Lift and press the clamping levers (A) on the two door hinges.	
Step 3	Close the oven door to the first opening position (approximately 70° angle). Hold the door at both sides and pull it away from the oven at an upwards angle. Put the door with the outer side down on a soft cloth on a stable surface.	

CARE AND CLEANING

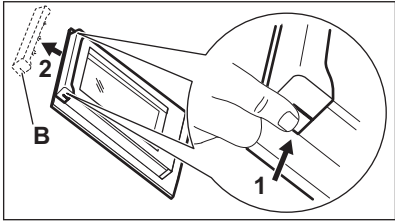
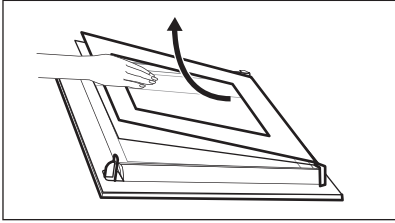
<p>Step 4</p>	<p>Hold the door trim (B) on the top edge of the door at the two sides and push inwards to release the clip seal.</p>	
<p>Step 5</p>	<p>Pull the door trim to the front to remove it.</p>	
<p>Step 6</p>	<p>Hold the door glass panels on their top edge one by one and pull them up out of the guide.</p>	
<p>Step 7</p>	<p>Clean the glass panel with water and soap. Dry the glass panel carefully. Do not clean the glass panels in the dishwasher.</p>	
<p>Step 8</p>	<p>After cleaning, do the above steps in the opposite sequence.</p>	
<p>Step 9</p>	<p>Install the smaller panel first, then the larger and the door.</p>	

11.6 How to replace: Lamp

WARNING!

Risk of electric shock.
The lamp can be hot.

Before you replace the lamp:

Step 1	Step 2	Step 3
Turn off the oven. Wait until the oven is cold.	Disconnect the oven from the mains.	Put a cloth on the bottom of the cavity.

Top lamp

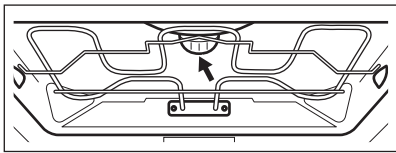
<p>Step 1</p>	<p>Turn the glass cover to remove it.</p>	
----------------------	-------------------------------------------	--------------------------------------------------------------------------------------

CARE AND CLEANING

Step 2	Clean the glass cover.
Step 3	Replace the lamp with a suitable 300 °C heat-resistant lamp.
Step 4	Install the glass cover.

Side lamp

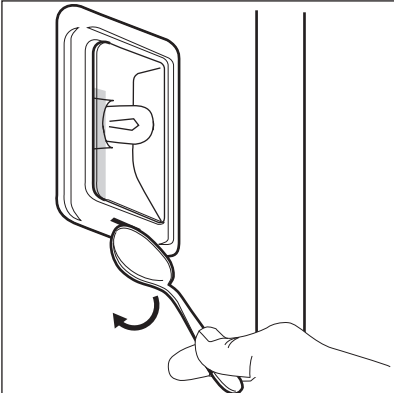
Step 1	Remove the left shelf support to get access to the lamp.	
Step 2	Use a narrow, blunt object (e.g. a teaspoon) to remove the glass cover.	
Step 3	Clean the glass cover.	
Step 4	Replace the lamp with a suitable 300 °C heat-resistant lamp.	
Step 5	Install the glass cover.	
Step 6	Install the left shelf support.	

12. TROUBLESHOOTING

WARNING!

Refer to Safety chapters.

12.1 What to do if...



The oven does not turn on or does not heat up



Possible cause



Remedy

The oven is not connected to an electrical supply or it is connected incorrectly.

Check if the oven is correctly connected to the electrical supply.

The clock is not set.

Set the clock, for details refer to "Clock Functions" chapter, How to set: Clock functions.

The door is not closed correctly.

Fully close the door.

The fuse is blown.

Make sure the fuse is the cause of the problem. If the problem recurs, contact a qualified electrician.

The oven Child Lock is on.

Refer to "Menu" chapter, Submenu for: Options.



Components need to be replaced



Description





Remedy

The lamp is burnt out.



Replace the lamp, for details refer to "Care and Cleaning" chapter, How to replace: Lamp.

Power cut always stops cleaning. Repeat cleaning if it's interrupted by power failure.

 Problems with Wi-Fi signal	
 Possible cause	 Remedy
Trouble with wireless network signal.	Check your wireless network and router. Restart the router.
New router installed or router configuration changed.	To configure oven and mobile device again, refer to "Before first use" chapter, Wireless connection.
The wireless network signal is weak.	Move router as close to the oven as possible.
The wireless signal is disrupted by a microwave appliance placed near the oven.	Turn off the microwave appliance.

12.2 How to manage: Error codes



When the software error occurs, the display shows error message. In this section, you will find the list of the problems that you can handle on your own.

 Code and description	 Remedy
C2 - the Food sensor is in the oven cavity during Pyrolytic Cleaning.	Take out the Food sensor.
C3 - the door is not fully closed during Pyrolytic Cleaning.	Close the door.
F111 - Food sensor is not correctly inserted into the socket.	Fully plug Food sensor into the socket.
F601 - there is a problem with Wi-Fi signal.	Check your network connection. Refer to "Before first use" chapter, Wireless connection.
F604 - the first connection to Wi-Fi failed.	Turn the oven off and on and try again. Refer to "Before first use" chapter, Wireless connection.
F908 - the oven system cannot connect with the control panel.	Turn the oven off and on.

When one of these error messages continues to appear on the display, it means a faulty subsystem may have been disabled. In such a case contact your dealer or an Authorized

TROUBLESHOOTING

Service Centre. If one of these errors occurs, the rest of the oven functions will continue to work as usually.

 Code and description	 Remedy
F602, F603 - Wi-Fi is not available.	Turn the oven off and on.

12.3 Service data

If you cannot find a solution to the problem yourself, contact your dealer or an Authorised Service Centre.

The necessary data for the service centre is on the rating plate. The rating plate is on the front frame of the oven cavity. Do not remove the rating plate from the oven cavity.

We recommend that you write the data here:	
Model (MOD.)
Product number (PNC)
Serial number (S.N.)

13. ENERGY EFFICIENCY

13.1 Product Information and Product Information Sheet*

Supplier's name	AEG	
Model identification	BPK948330B 944188474 BPK948330M 944188475	
Energy Efficiency Index	61.2	
Energy efficiency class	A++	
Energy consumption with a standard load, conventional mode	1.09 kWh/cycle	
Energy consumption with a standard load, fan-forced mode	0.52 kWh/cycle	
Number of cavities	1	
Heat source	Electricity	
Volume	71 l	
Type of oven	Built-In Oven	
Mass	BPK948330B	35.5 kg
	BPK948330M	35.5 kg

* For European Union according to EU Regulations 65/2014 and 66/2014.
For Republic of Belarus according to STB 2478-2017, Appendix G; STB 2477-2017, Annexes A and B.
For Ukraine according to 568/32020.

Energy efficiency class is not applicable for Russia.

EN 60350-1 - Household electric cooking appliances - Part 1: Ranges, ovens, steam ovens and grills - Methods for measuring performance.

13.2 Energy saving



The oven has features which help you save energy during everyday cooking.

Make sure that the oven door is closed when the oven operates. Do not open the oven door too often during cooking. Keep the door gasket clean and make sure it is well fixed in its position. Use metal cookware to improve energy saving.

ENERGY EFFICIENCY

When possible, do not preheat the oven before cooking.

Keep breaks between baking as short as possible when you prepare a few dishes at one time.

Cooking with fan

When possible, use the cooking functions with fan to save energy.

Residual heat

If a programme with the Duration or End Time selection is activated and the cooking time is longer than 30 min, the heating elements automatically turn off earlier in some oven functions. The fan and lamp continue to operate. When you turn off the oven, the display shows the residual heat. You can use that heat to keep the food warm.

When the cooking duration is longer than 30 min, reduce the oven temperature to minimum 3 - 10 min before the end of cooking. The residual heat inside the oven will continue to cook.

Use the residual heat to warm up other dishes.

Keep food warm

Choose the lowest possible temperature setting to use residual heat and keep a meal warm.

The residual heat indicator or temperature appears on the display.

Cooking with the lamp off

Turn off the lamp during cooking. Turn it on only when you need it.

Moist Fan Baking

Function designed to save energy during cooking.

When you use this function the lamp automatically turns off after 30 sec. You may turn on the lamp again but this action will reduce the expected energy savings.

14. MENU STRUCTURE

14.1 Menu

Select: Menu and press the knob.

Menu item		Application
Assisted cooking		Lists automatic programmes.
Favourites		Lists the favourite settings.
Cleaning		Lists cleaning programmes.
Options		To set the oven configuration.
Settings	Connections	To set the network configuration.
	Setup	To set the oven configuration.
	Service	Shows the software version and configuration.

14.2 Submenu for: Cleaning

Submenu	Application
Quick	Duration: 1 h.
Normal	Duration: 1 h 30 min.
Intense	Duration: 3 h.
Cleaning Reminder	Reminds you when to clean the oven.

14.3 Submenu for: Options

Submenu	Application
Light	Turns the lamp on and off.
Lamp icon visible	Lamp icon appears on the screen.

MENU STRUCTURE

Submenu	Application
Child lock	Prevents accidental activation of the oven. When the option is on, the text "Child Lock" appears on the display when you turn on the oven. To enable the oven use, choose the code letters in the alphabetical order. When the Child Lock is on and the oven is turned off the oven door are locked.
Fast heat up	Shortens heat up time. It is available only for some of the oven functions.

14.4 Submenu for: Connections

Submenu	Description
Wi-Fi	To enable and disable: Wi-Fi.
Remote operation	To enable and disable remote control. Option visible only after you turn on: Wi-Fi.
Network	To check network status and the signal power of: Wi-Fi.
Auto remote operation	To start remote operation automatically after pressing START. Option visible only after you turn on: Wi-Fi.
Forget network	To disable current network from auto connection with the oven.

14.5 Submenu for: Setup

Submenu	Description
Language	Sets the oven language.
Time of day	Sets the current time and date.
Time indication	Turns the clock on and off.
Digital clock style	Changes the format of the displayed time indication.
Cleaning Reminder	Turns the reminder on and off.

Submenu	Description
Key tones	Turns the tone of the touch fields on and off. It is not possible to mute the tones for: ①, STOP .
Alarm / Error tones	Turns the alarm tones on and off.
Buzzer volume	Sets the volume of key tones and signals.
Display brightness	Sets the display brightness.

14.6 Submenu for: Service

Submenu	Description
Demo mode	Activation / deactivation code: 2468
Licence	Information about licenses.
Software version	Information about software version.
Reset all settings	Restores factory settings.
Reset all popups	Restores all pop-ups to the original settings.

15. IT'S EASY!



Before first use you have to set:

Language	Display brightness	Buzzer volume	Time of day
----------	--------------------	---------------	-------------



Familiarize yourself with the basic icons on the control panel and the display:

 On / Off	 Information	 Timer options	 Food sensor	START / STOP
-----------------------------------------------------------------------------------------------	--------------------------------------------------------------------------------------------------	----------------------------------------------------------------------------------------------------	--------------------------------------------------------------------------------------------------	-----------------

Start using the oven

Quick start	Turn on the oven and start cooking with the default temperature and time of the function.	Step 1	Step 2	Step 3
		Press and hold: 	 ... - press the oven function and then press the knob.	Press: START .
Quick Off	Turn off the oven at any time, any screen or message.	 - press and hold until the oven turns off.		



Start cooking

Step 1	Step 2	Step 3	Step 4
 - press to turn on the oven.	 ... - select the heating function and press the knob.	 - turn the knob to set the temperature and press.	START - press to start cooking.

Get to know how to cook quickly

Use the automatic programmes to prepare a dish quickly with the default settings:

Step 1	Step 2	Step 3	Step 4	Step 5
Press: 	Select: Menu. Press the knob.	Select: Assisted cooking . Press the knob.	Choose the food category.	Choose the dish and press the knob.

Use quick functions to set the cooking time or change the cooking function		
Quick timer settings Use the most used timer settings by choosing from the shortcuts.	Step 1	Step 2
	Select: Timer . Press the knob.	Select preferred timer value and press the knob.
10% Finish assist Use 10% Finish assist to add extra time or change cooking function when 10% of the cooking time is left.	+1 min +5 min +10 min - press the preferred time icon to extend the cooking time.	
	Change function: Select preferred function    ... - select preferred function. Press the knob.	

16. TAKE A SHORTCUT!

Here you can see all the useful shortcuts. You can also find them in the dedicated chapters in the user manual.

Wireless connection



How to set: Heating functions



How to set: Assisted cooking



How to set: Cooking time



How to delay: Start and end of cooking



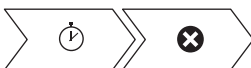

How to cancel: Set Timer



How to use: Food Sensor



17. ENVIRONMENTAL CONCERNS

Recycle materials with the symbol . Put the packaging in relevant containers to recycle it. Help protect the environment and human health by recycling waste of electrical and electronic appliances. Do not dispose of appliances marked with the symbol  with the household waste. Return the product to your local recycling facility or contact your municipal office.

www.aeg.com/shop



867362240-A-372020