

Built-in Oven

User & Installation manual

NV7B564**** / NV7B565**** / NV7B566**** / NV7B567**** /
NV7B568**** / NV7B564**C* / NV7B566**C* / NV7B568**C* /
NV7B574**** / NV7B575**** / NV7B576**** / NV7B577**** /
NV7B578****



SAMSUNG

Contents

Using this manual	3	Natural Steam	20
The following symbols are used in this User Manual:	3	Dual cook mode temperature setting range	25
Safety instructions	3	Air Fry	26
Important safety precautions	3	Air Sous Vide	28
Correct Disposal of This Product (Waste Electrical & Electronic Equipment)	6	To stop cooking	30
Auto energy saving function	6	Special Function	31
Installation	6	Auto Cook	32
What's included	6	Cleaning	33
Prepare to install the oven	7	More Functions	36
Power connection	7	System Settings	37
Cabinet mount	8	Smart Control	37
Before you start	10	Cooking smart	38
Initial settings	10	Manual cooking	38
Clock	10	Auto cook programmes	43
New oven smell	10	Test dishes	48
Smart safety mechanism	10	Collection of frequent Auto cook recipes	49
Soft closing door (gentle, safe, and silent)	11	Maintenance	52
Assembling the steam container	11	Cleaning	52
Accessories	12	Replacement	56
Water reservoir	13	Troubleshooting	56
Mechanical lock	13	Checkpoints	56
Flexible Door	14	Information codes	58
Dual cook mode	15	Technical specifications	59
Operations	15	Appendix	60
Control panel	15	Product data sheet	60
Common settings	16	Open Source Announcement	61
Cooking modes	18		

Using this manual

Thank you for choosing SAMSUNG Built-In Oven. This User Manual contains important information on safety and instructions intended to assist you in the operation and maintenance of your appliance. Please take the time to read this User Manual before using your oven and keep this book for future reference.

The following symbols are used in this User Manual:

WARNING

Hazards or unsafe practices that may result in **severe personal injury, death and/or property damage**.

CAUTION

Hazards or unsafe practices that may result in **personal injury and/or property damage**.

NOTE

Useful tips, recommendations, or information that helps users manipulate the product.

Safety instructions

Installation of this oven must be performed only by a licensed electrician. The installer is responsible for connecting the appliance to the mains power supply in observance of the relevant safety recommendations.

IMPORTANT SAFETY PRECAUTIONS

WARNING

This appliance is not intended for use by persons (including children) with reduced physical, sensory or mental capabilities, or lack of experience and knowledge, unless they have been given supervision or instruction concerning use of the appliance by a person responsible for their safety.

Children should be supervised to ensure that they do not play with the appliance.

The means for disconnection must be incorporated in the fixed wiring in accordance with the wiring rules.

This Appliance should be allowed to disconnection from the supply after installation. The disconnection may be achieved by having the plug accessible or by incorporating a switch in the fixed wiring in accordance with the wiring rules.

If the supply cord is damaged, it must be replaced by the manufacturer, its service agent or similarly qualified persons in order to avoid a hazard.

Safety instructions

The method of fixing stated is not to depend on the use of adhesives since they are not considered to be a reliable fixing means.

This appliance can be used by children aged from 8 years and above and persons with reduced physical, sensory or mental capabilities or lack of experience and knowledge if they have been given supervision or instruction concerning use of the appliance in a safe way and understand the hazards involved. Children shall not play with the appliance. Cleaning and user maintenance shall not be made by children without supervision. Keep the appliance and its cord out of reach of children less than 8 years.

During use the appliance becomes hot. Care should be taken to avoid touching heating elements inside the oven.

WARNING: Accessible parts may become hot during use. Young children should be kept away.

Do not use harsh abrasive cleaners or sharp metal scrapers to clean the oven door glass since they can scratch the surface, which may result in shattering of the glass.

If this appliance has cleaning function, excess spillage must be removed before cleaning and all utensils should not be left in the oven during steam cleaning or self cleaning. The cleaning function depends on the model.

If this appliance has cleaning function, during cleaning conditions the surfaces may get hotter than usual and children should be kept away. For appliances with pyrolytic cleaning process, Some animals, particularly birds, can be sensitive to the fumes and local temperature fluctuations during the pyrolytic cleaning process and should be moved to an appropriate well ventilated area during this process.

Ventilate the room during and after the pyro cleaning process.

The cleaning function depends on the model.

Only use the temperature probe recommended for this oven. (Meat probe model only)

A steam cleaner is not to be used.

WARNING: Ensure that the appliance is switched off before replacing the lamp to avoid the possibility of electric shock.

The appliance must not be installed behind a decorative door in order to avoid overheating.

WARNING: The appliance and its accessible parts become hot during use. Care should be taken to avoid touching heating elements. Children less than 8 years of age shall be kept away unless continuously supervised.

CAUTION: The cooking process has to be supervised. A short term cooking process has to be supervised continuously.

The door or the outer surface may get hot when the appliance is operating.

The temperature of accessible surfaces may be high when the appliance is operating. The surfaces are liable to get hot during use.

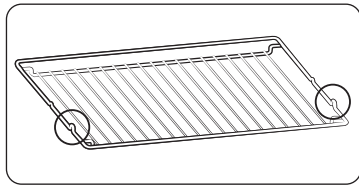

Insert the wire rack into position with the protruding parts (stoppers on both sides) towards the front so that the wire rack supports the rest position for large loads.

⚠ CAUTION

If the oven has been damaged in transport, do not connect it.

This appliance must be connected to the mains power supply only by a specially licensed electrician.

In the event of a fault or damage to the appliance, do not attempt to operate it. Repairs should be performed by a licensed technician only. Improper repair may result in considerable danger to you and others. If your oven needs repair, contact a SAMSUNG Service center or your dealer.

Electrical leads and cables should not be allowed to touch the oven.

The oven should be connected to the mains power supply by means of an approved circuit breaker or fuse. Never use multiple plug adapters or extension leads.

The power supply of the appliance should be turned off when it is being repaired or cleaned.

Take care when connecting electrical appliances to sockets near the oven.

If this appliance has a vapour or steam cooking function, do not operate this appliance when the water supply cartridge is damaged. (Vapour or steam function model only)

When the cartridge is cracked or broken, do not use it and contact your nearest service center. (Vapour or steam function model only)

This oven has been designed only for the cooking of household foods.

During use, the oven interior surfaces become hot enough to cause burns. Do not touch heating elements or interior surfaces of the oven until they have had time to cool.

Never store flammable materials in the oven.

The oven surfaces become hot when the appliance is operated at a high temperature for an extended period of time.

When cooking, take care when opening the oven door as hot air and steam can escape rapidly.

When cooking dishes that contain alcohol, the alcohol may evaporate due to the high temperatures and the Vapour can catch fire if it comes into contact with a hot part of the oven.

For your safety, do not use high-pressure water cleaners or steam jet cleaners.

Children should be kept at a safe distance when the oven is in use.

Frozen foods such as pizzas should be cooked on the big grid. If the baking tray is used, it may become deformed due to the great variation in temperatures.

Do not pour water into the bottom of the oven when it is hot. This could cause damage to the enamel surface.

The oven door must be closed during cooking.

Do not line the bottom of the oven with aluminum foil and do not place any baking trays or tins on it. The aluminum foil blocks the heat, which may result in damage to the enamel surfaces and cause poor cooking results.

Fruit juices will leave stains, which can become permanent on the enamel surfaces of the oven.

When cooking very moist cakes, use the deep pan.

Do not rest bakeware on the open oven door.

Keep children away from the door when opening or closing it as they may bump themselves on the door or catch their fingers in the door.

Do not step, lean, sit or place heavy items on the door.

Do not open the door with unnecessarily strong force.

WARNING: Do not disconnect the appliance from the main power supply even after the cooking process is completed.

WARNING: Do not leave the door open while oven is cooking.

Safety instructions

Correct Disposal of This Product (Waste Electrical & Electronic Equipment)



(Applicable in countries with separate collection systems)

This marking on the product, accessories or literature indicates that the product and its electronic accessories (e.g. charger, headset, USB cable) should not be disposed of with other household waste at the end of their working life. To prevent possible harm to the environment or human health from uncontrolled waste disposal, please separate these items from other types of waste and recycle them responsibly to promote the sustainable reuse of material resources.

Household users should contact either the retailer where they purchased this product, or their local government office, for details of where and how they can take these items for environmentally safe recycling.

Business users should contact their supplier and check the terms and conditions of the purchase contract. This product and its electronic accessories should not be mixed with other commercial wastes for disposal.

For information on Samsung's environmental commitments and product-specific regulatory obligations, e.g. REACH, WEEE, Batteries, visit : www.samsung.com/uk/aboutsamsung/sustainability/environment/our-commitment/data/

Auto energy saving function

Light : During cooking process, you can switch off Oven lamp by pressing 'Oven light' button. For energy saving, the oven lighting is switched off a few minutes after cooking program has started.

Installation

⚠ WARNING

This product is dedicated to built-in products.

This oven must be installed by a qualified technician. The installer is responsible for connecting the oven to the main power, while observing the relevant safety regulations of your area.

What's included

Make sure all parts and accessories are included in the product package. If you have a problem with the oven or accessories, contact a local Samsung customer centre or the retailer.

Oven at a glance

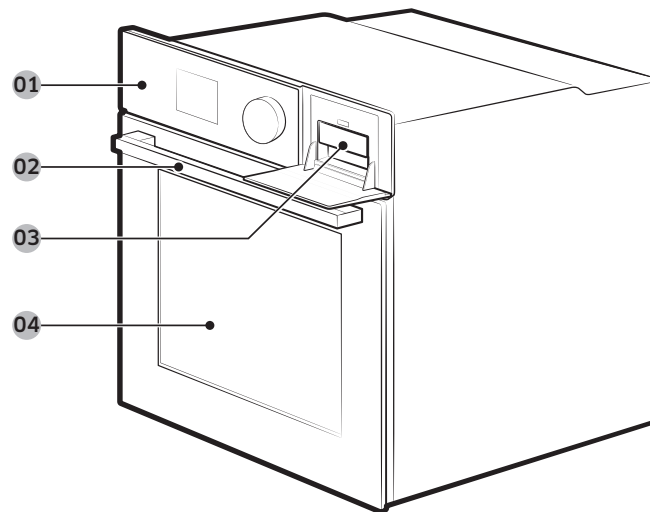

01 Control panel

02 Door handle

03 Water reservoir (*)

04 Door

📖 NOTE

Depending on the model, this oven comes in two types: single door and dual door.

Accessories

The oven comes with different accessories that help you prepare different types of food.



Wire rack

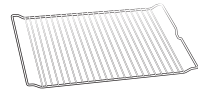

Wire rack insert (*)

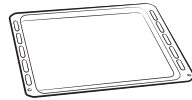

Baking tray (*)



Universal tray (*)



Extra-deep tray (*)

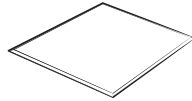

Divider

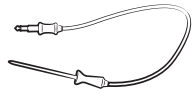

Meat probe (*)

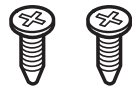

2 screws (M4 L25)

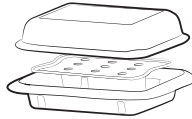

Steam container (*)



Steam tray (*)



Air Fry tray (*)

NOTE

Availability of accessories with an asterisk (*) depends on the oven model.

Prepare to install the oven



Phillips Screwdriver



Drill

Power connection

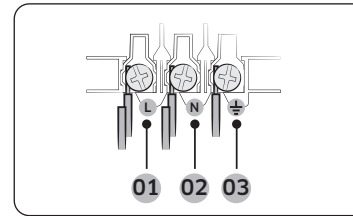

- 01 BROWN or BLACK
- 02 BLUE or WHITE
- 03 YELLOW and GREEN

Plug the oven into an electrical socket. If a plug-type socket is not available due to allowable current limitations, use a multi-pole isolator switch (with at least 3 mm spacing in-between) to meet safety regulations. Use a power cord of sufficient length that supports the specification H05 RR-F or H05 VV-F, min. 1.5 ~ 2.5 mm².

Rated current (A)	Minimum cross-sectional area
10 < A ≤ 16	1.5 mm ²
16 < A ≤ 25	2.5 mm ²

Check the output specifications on the label attached to the oven.

Open the rear cover of the oven using a screwdriver, and remove the screws on the cord clamp. Then, connect the power lines to the relevant connection terminals.

The (PE)-terminal is designed for earth grounding. First connect the yellow and green lines (earth grounding), which must be longer than the others. If you use a plug-type socket, the plug must remain accessible after the oven is installed. Samsung is not responsible for accidents caused by missing or faulty earth grounding.

WARNING

Do not step on or twist the wires during installation, and keep them away from heat-emitting parts of the oven.

Installation

Cabinet mount

If installing the oven in a built-in cabinet, the cabinet must have its plastic surfaces and adhesive parts resistant up to 90 °C. Samsung is not responsible for damage to furniture from the oven's heat emission.

The oven must be properly ventilated. For ventilation, leave a gap of about 50 mm between the lower shelf of the cabinet and the supporting wall. If you install the oven under a cooktop, follow the cooktop's installation instructions.

Required dimensions for installation

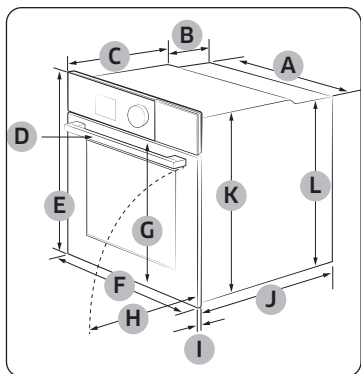

Oven (mm)

A	560	G	503
B	166	H	481
C	383	I	21
D	45	J	549
E	596	K	579
F	595	L	559

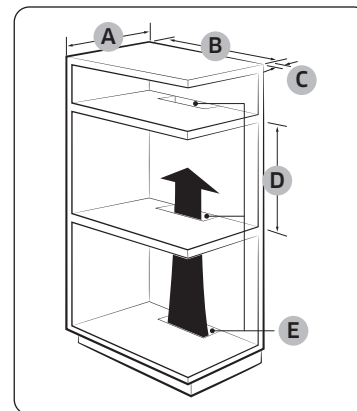

Built-in cabinet (mm)

A	Min. 550
B	Min. 560
C	Min. 50
D	Min. 590 - Max. 600
E	Min. 460 x Min. 50

NOTE

The built-in cabinet must have vents (**E**) to ventilate heat and circulate the air.

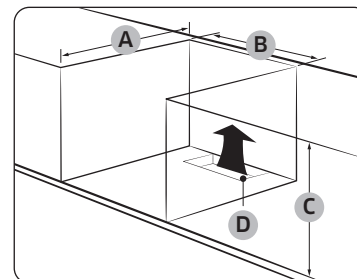

Under-sink cabinet (mm)

A	Min. 550
B	Min. 560
C	Min. 600
D	Min. 460 x Min. 50

NOTE

- The built-in cabinet must have vents (**D**) to ventilate heat and circulate the air.
- Minimum height requirement (**C**) is for oven installation alone.

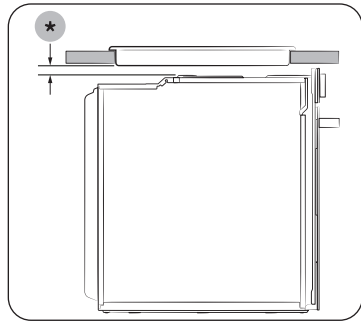

Installing with a hob
To install a hob on top of the oven, check the installation guide of the hob for the installation space requirement (*).

Mounting the oven

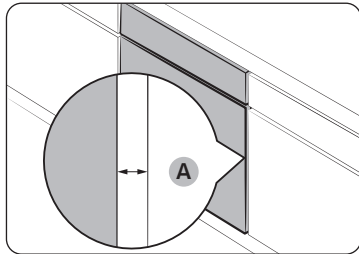

Make sure to leave a gap (A) of at least 5 mm between the oven and each side of the cabinet.

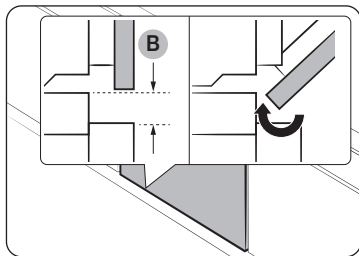

Secure at least 3 mm of gap (B) so that the door opens and closes smoothly.

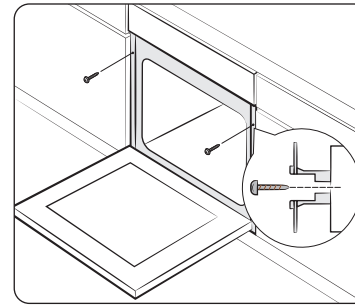

Fit the oven into the cabinet and fix the oven firmly on both sides using 2 screws.

After installation is complete, remove the protective film, tape, and other packing material, and take out the provided accessories from inside the oven. To remove the oven from the cabinet, disconnect power to the oven first, and then remove 2 screws on both sides of the oven.

⚠ WARNING

The oven requires ventilation for normal operation. Do not block the vents under any circumstance.

📖 NOTE

The actual appearance of the oven may differ with the model.

Before you start

Initial settings

When you turn on the oven for the first time, the First Use Guide screen appears. Complete the on-screen instructions, and the First Use Guide will not appear again. Once you complete the First Use Guide, the default time and date (12:00 Jan 1) appears on the screen. Follow the steps below to set the current time and date.

Clock

It is important to set the correct time to ensure correct automatic operations.

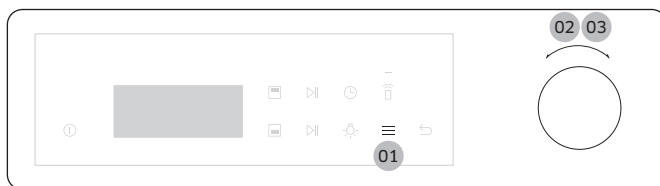

To set the clock time

1. Tap .
2. Select **Set time** using the **Dial Knob**, and then press the **Dial Knob**.
3. Set the current time using the **Dial Knob**, and then press the **Dial Knob**. (Hour, minute, and AM/PM if necessary)

To set the date

1. Tap .
2. Select **Set date** using the **Dial Knob**, and then press the **Dial Knob**.
3. Set the current date using the **Dial Knob**, and then press the **Dial Knob**. (Month, day, and year)

To set the time format

1. Tap .
2. Select **Time format** using the **Dial Knob**, and then press the **Dial Knob** to confirm.
3. Turn the **Dial Knob** to select 12hr or 24hr, and then press the **Dial Knob**.

NOTE

You cannot change the clock time while the oven is operating.

New oven smell

Before using the oven for the first time, clean inside the oven to remove the new oven smell.

1. Remove all accessories from inside the oven.
2. Run the oven with Convection 200 °C or Conventional 200 °C for an hour. This will burn any remaining production substances in the oven.
3. When complete, turn off the oven.

NOTE

- At the first-time use, you may see some smoke inside the oven while it is operating. However, this is not a product failure.
- As the temperature of the cooking room increases at an initial period, you may find some spots on the inner glass of the door. If this is the case, turn off the oven and wait until it cools down. Then, use kitchen paper or neutral detergent with a clean cloth to wipe up the inner glass.
- It is also important to make sure that you operate the oven in a well-ventilating kitchen environment.

Smart safety mechanism

If you open the door while the oven is operating, the oven light turns on, and both the fan and the heating elements stop operation. This is to prevent physical injuries such as burns as well as to prevent unnecessary energy loss. When this happens, simply close the door, and the oven continues to operate normally because this is not a system failure.

Soft closing door (gentle, safe, and silent) (applicable models only)

The Samsung Built-in Oven features a soft closing door that gently, safely, and silently closes.

When closing the door, the specially designed hinges catch the door a few centimetres before the final position. This is the perfect touch for added comfort, allowing the door to be closed silently and gently.

(Availability of this feature depends on the oven model.)

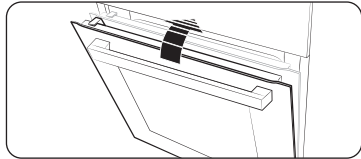

The door starts to be closed softly at about 15 degrees and completely closed within approx. 5 seconds.

Assembling the steam container (applicable models only)

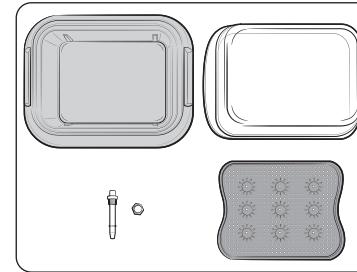

1. Check and make sure you have all the parts for the steam container.

- Parts includes glass lid, metal pan, steam tray, and steam nozzle.

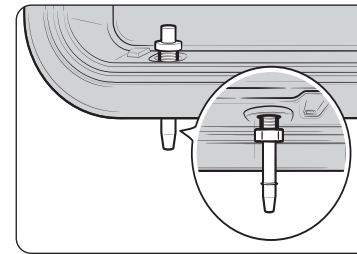

2. Insert the steam nozzle to the hole on the right-rear side of the metal pan, and then tighten the provided nut.

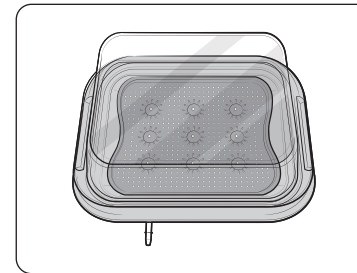

3. Put the steam tray in the metal pan, and then close the glass lid to use it in the oven.

Before you start

Before you start

Accessories

For first time use, clean the accessories thoroughly with warm water, detergent and a soft clean cloth.

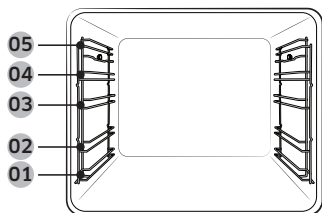

- 01 Level 1
- 02 Level 2
- 03 Level 3
- 04 Level 4
- 05 Level 5

- Insert the accessory to the correct position inside of the oven.
- Allow at least a 1 cm space from the accessory and the bottom of the oven, and from any other accessory.
- Take caution in removing cookware and/or accessories out of the oven. Hot meals or accessories can cause burns.
- The accessories may be deformed while they are gaining heat. Once they have cooled down, they will recover their original appearance and performance.

Basic use

For better cooking experience, familiarise yourself with how to use each accessory.

Wire rack	The wire rack is designed for grilling and roasting. Insert the wire rack into position with the protruding parts (stoppers on both sides) towards the front.
Wire rack insert (*)	The wire rack insert is used with the tray and prevents liquid from dripping onto the bottom of the oven.
Baking tray (*)	The baking tray (depth: 20 mm) is used for baking cakes, cookies, and other pastries. Put the slanted side to the front.
Universal tray (*)	The universal tray (depth: 30 mm) is used for cooking and roasting. Use the wire-tray insert to prevent liquid from dripping onto the bottom of the oven. Put the slanted side to the front.
Extra-deep tray (*)	The extra-deep tray (depth: 50 mm) is used for roasting with or without the wire-tray insert. Put the slanted side to the front.

Telescopic rails (*)	Use the telescopic rail plate to insert the tray as follows: <ol style="list-style-type: none"> 1. Stretch the rail plate out from the oven. 2. Put the tray on the rail plate and slide the rail plate into the oven. 3. Close the oven door.
Divider	The divider is designed to separate the oven in two zones. Use the divider with Dual cook mode. Do not use the divider as a shelf.
Meat probe (*)	The meat probe measures the internal temperature of the meat to cook. Use only the meat probe that comes with your oven.
Steam container (*)	The steam container is only for steam assisted modes. Use the steam container on the steam container level only and make sure to insert fully into the compartment so the container touches the rear wall. The steam container has 4 separate parts: Glass lid, metal pan, steam tray, and steam nozzle. The glass lid can be used as baking and gratin dish. ⚠ WARNING <ul style="list-style-type: none"> • Always wear oven mittens when handling the steam container and be careful not to drop the steam container. • Sudden temperature changes could cause glass parts to break or shatter.
Steam tray (*)	Use the steam tray only in Natural Steam mode. Put the tray in the bottom center of the compartment and fill it with clean water. As the tray becomes hot during or immediately after cooking, be sure to use oven gloves or wait until the oven cools down completely to remove the tray.
Air Fry tray (*)	Use the Air Fry tray only in Air Fry mode. As the tray becomes hot during or immediately after cooking, be sure to use oven gloves or wait until the oven cools down completely to remove the tray.

NOTE

Availability of accessories with an asterisk (*) depends on the oven model.

Water reservoir (applicable models only)

The water reservoir is used for steam functions. Fill it with water in advance of steam cooking.

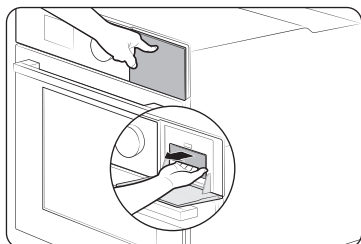

1. Locate the water reservoir in the top-right corner. Push in the reservoir to open and remove.

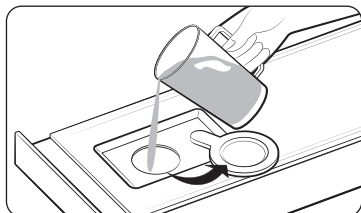

2. Open the reservoir cap, and fill the reservoir with 500 ml of drinkable water.
3. Close the cap, and reinsert the reservoir.

NOTE

Insert the water reservoir to the end until it locks.

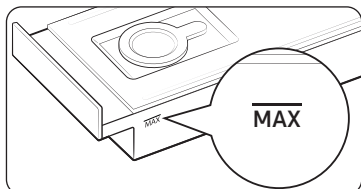

NOTE

Do not exceed the max line.

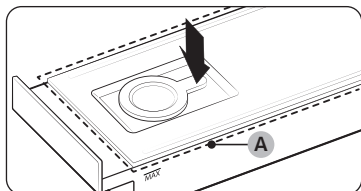

NOTE

Make sure the upper case (A) of the water reservoir is closed before using the oven.

Mechanical lock (applicable models only)

Installation

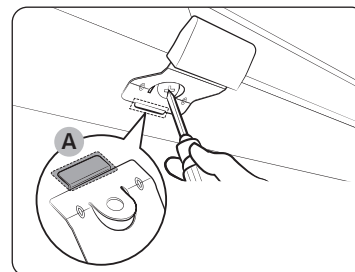

1. Insert the thin part (A) of the mechanical lock into the corresponding slot of the lock handle as shown.
2. Tighten the screw on the lock handle.

Uninstallation

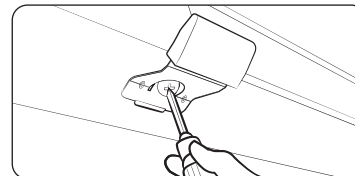

- Loosen and remove the screw from the lock handle.

Lock/unlock

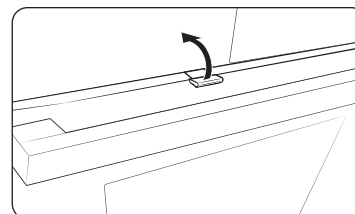

- To open the door, slightly lift up the lock handle to unlock the door. Then, open the door.
- To lock the door, simply close the door. The mechanical lock automatically locks the door.

Before you start

Flexible Door (applicable models only)

This oven has a unique Flexible Door that is hinged in the middle, so you only need to open the top half to access the upper zone. When you're using the Dual Cook capability, you can access the top oven space much more easily and with greater energy efficiency.

How to use the upper door

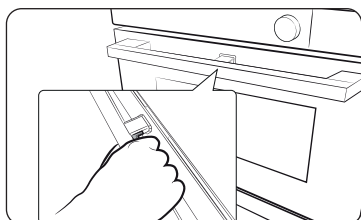

1. Completely press the handle lever.

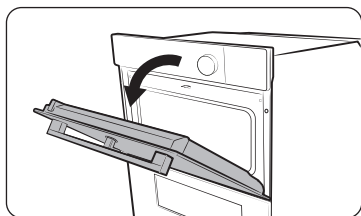

2. Pull the handle.

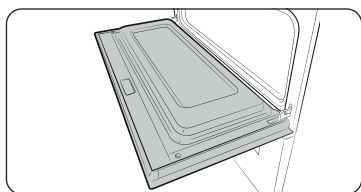

3. This will open only the upper door as shown.

How to use the full door

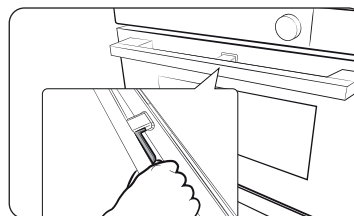

1. Hold the lever-less area of the handle, and then pull.

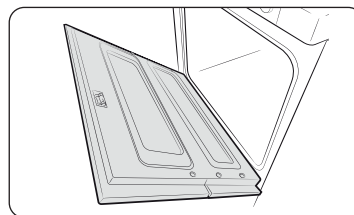

2. This will open the whole door as shown.

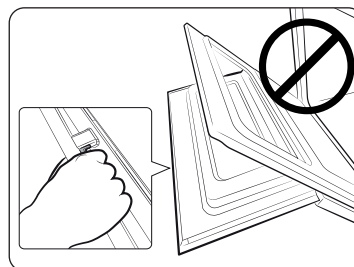

⚠ CAUTION

When opening the whole door, make sure to grasp the handle by the lever-less portion. If the lever is pressed halfway through opening the door, the upper door may open, causing physical injury.

📖 NOTE

- Do not put heavy objects on, or apply excessive force, to the upper door.
- Do not let children play with or on the upper door.

Dual cook mode

You can use both the upper and lower zones for cooking two different recipes, or simply choose one zone to cook with.

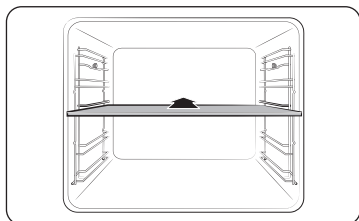

Insert the divider in level 3 to separate the cooking chamber in two zones. The oven senses the divider and activates the upper zone by default.

NOTE

Availability of Dual cook mode depends on the recipe. For more information, see the **Cooking smart** section in this manual.

Operations

Control panel

The front panel comes in a wide range of materials and colours. For improved quality, the actual appearance of the oven is subject to change without notice.

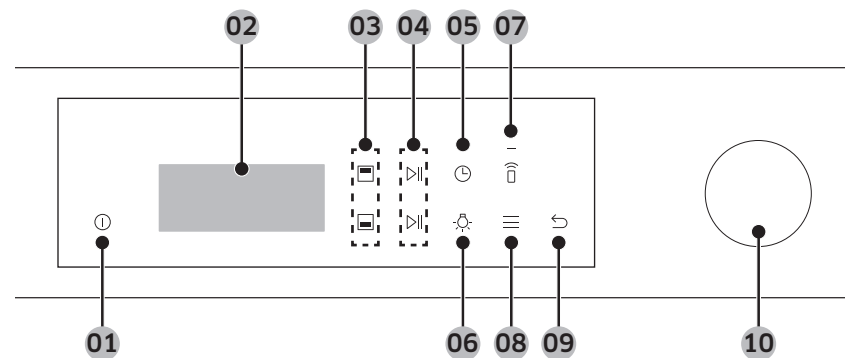

01 Power	Press to turn the oven on. To turn it off, hold down for 1 seconds.
02 Screen	Displays the menu, information, and cooking progress.
03 Upper / Lower zone selector	You can select the upper zone or lower zone to control. The buttons become active when you insert the divider into the oven.
04 Start / Stop	Tap to start or stop the oven operation. Tap and hold 3 seconds during cooking to cancel. In Dual cook mode, use the upper button for the upper zone, and the lower button for the lower zone.
05 Cooking Time	Tap to set the cooking time.
06 Light	Tap to turn the oven light on or off.



Operations

07 Smart Control	Set the Smart Control function on or off. NOTE Easy Connection must be set before using this function.
08 Options	Tap to see the Options list. Tap and hold 3 seconds to see the System settings.
09 Back	Tap to move to the previous screen or to cancel the cooking.
10 Dial Knob	Turn left and right to navigate through the menus and lists. An item will be selected to show you where you are on the screen. Press to select the item.

NOTE

Tapping on the display while wearing plastic or oven gloves may not operate properly.

Common settings

It is common to change the default temperature and/or cooking time across all cooking modes. Follow the steps below to adjust the temperature and/or cooking time for the selected cooking mode.

Most used mode and temperature

- The default order of the cooking modes will automatically change after you use the oven for 10 times. The cooking mode list will be arranged in the most used mode to least used mode so you can quickly select the cooking mode you used the most.
- The default temperature of a cooking mode will automatically change if you have used the specific temperature for that cooking mode more than 3 times.

Mode and temperature

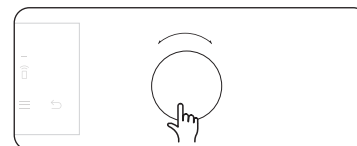

1. Turn the **Dial Knob** to choose a mode or function, and then press **Dial Knob**.
- The default temperature of the selected mode appears.

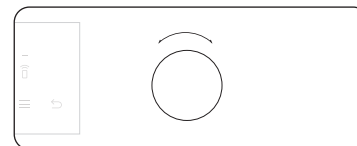

2. Turn the **Dial Knob** to set the desired temperature.

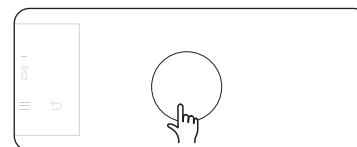

3. Press the **Dial Knob** to confirm.



NOTE

- To change the set temperature, turn the **Dial Knob** to set the desired temperature, and then tap lower ▷||.
- The exact temperature inside the oven can be measured with authorized thermometer and method defined by an authorized institution. Using other thermometers may cause a measuring error.

Cooking time

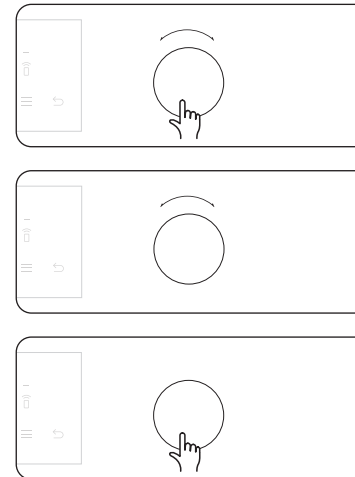

1. Select a cooking mode and set the temperature.
- See the “**Mode and temperature**” section for detailed instructions.
2. Turn the **Dial Knob** to select **Set Cook Time**, and then press the **Dial Knob** to confirm.
- Alternatively, you can tap ⌚ to set the cooking time.
3. Turn the **Dial Knob** to set the desired time up to 23 hours and 59 minutes.
4. Press the **Dial Knob** to confirm.

NOTE

- You can cook without setting the cooking time if you want to. In this case, the oven starts cooking at set temperatures without time information, and you must stop the oven manually.
- To change the set cooking time, tap ⌚ and follow the above steps.

Operations

End time

1. Select a cooking mode and set the temperature.
- See the "Mode and temperature" section for detailed instructions
2. Set the cooking time.
- See the "Cooking time" section for detailed instructions.
3. Turn the **Dial Knob** to select "Ready at (time)", and then press the **Dial Knob** to confirm.
4. Turn the **Dial Knob** to set the desired end time.
5. Press the **Dial Knob** to confirm.

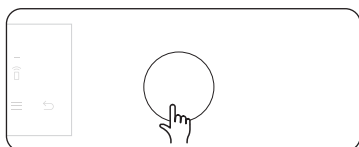
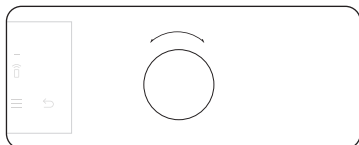
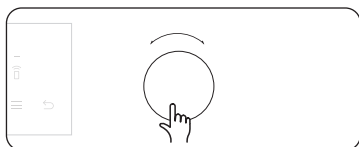



NOTE

- You can cook without setting the end time if you want to. In this case, the oven starts cooking at set temperatures immediately and end cooking when the desired cook time is up.
- To change the end time, tap  and follow the above steps.

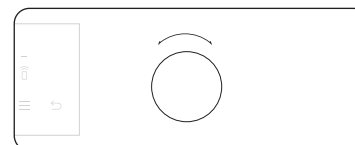
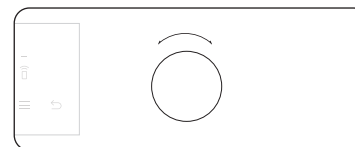
Cooking modes



1. Turn the **Dial Knob** to select a cooking mode.
2. Set the cooking time and/or temperature if necessary. See the **Common settings** section for details.
3. After setting the mode, temperature, and the cooking time, turn the **Dial Knob** to select **Set Fast Preheat**. Then, turn on the option.
- The Fast Preheat option may not be available for some cooking modes.

The oven starts preheating with the Preheat icon , or Fast Preheat icon , until the internal temperature reaches the target temperature.

When preheating is complete, the indicator disappears with a beep.







Preheating is recommended for all cooking modes unless otherwise specified in the cooking guide.







NOTE

You can change the cooking time and/or temperature during cooking.

Cooking mode descriptions

The cooking modes with an asterisk (*) are available for fast preheating and disabled for temperatures set at less than 100 °C.

Mode		Temperature range (°C)				Suggested temperature (°C)
		Single	Dual			
			Upper	Lower	Dual	
	Convection	* 30-250	40-250	40-250	40-250	160
		The rear heating element generates heat, which is evenly distributed by the convection fan. Use this mode for baking and roasting on different levels at the same time.				
	Conventional	* 30-250	-	-	-	180
		The heat is generated from the top and bottom heating elements. This function should be used for standard baking and roasting for most types of dishes.				
	Eco Convection	30-250	-	-	-	160
		Eco Convection uses the optimized heating system to save energy while cooking. The cooking times slightly increases, but the cooking results remain the same. Note that this mode does not require preheating. NOTE ECO Convection mode of heating used to determine the energy efficiency class is in accordance with EN60350-1				
Grill						
	Large grill	100-270	40-250	-	40-250	220
		The large-area grill emits heat. Use this mode for browning the tops of food (for example, meat, lasagne, or gratin).				
	Eco grill	100-270	-	-	-	220
		The small-area grill emits heat. Use this mode for food that requires less heat, such as fish and filled baguettes.				
	Fan grill	100-250	-	-	-	180
		Two top heating elements generate heat, which is distributed by the fan. Use this mode for grilling meat or fish.				

Mode		Temperature range (°C)				Suggested temperature (°C)
		Single	Dual			
			Upper	Lower	Dual	
	Top heat + Convection	* 40-250	40-250	-	40-250	180
		The top heating element generates heat, which is evenly distributed by the convection fan. Use this mode for roasting that requires a crispy top (for example, meat or lasagne).				
	Bottom heat + Convection	* 40-250	-	40-250	40-250	200
		The bottom heating element generates heat, which is evenly distributed by the convection fan. Use this mode for pizza, bread, or cake.				
	Bottom heat	100-230	-	40-250	40-250	150
		The bottom heating element generates heat. Use this mode at the end of baking or cooking to brown the bottoms of a quiche or pizza.				
	Pro-Roasting	80-200	-	-	-	160
		Pro-Roasting runs an automatic pre-heating cycle until the oven temperature reaches 220 °C. Then, the top heating element and the convection fan start operating to sear food such as meat. After searing, the meat will be cooked at low temperatures. Use this mode for beef, poultry, or fish.				
	Air Sous Vide	50-95	-	-	-	60
		Air Sous Vide mode uses low-temperature hot air to implement Sous Vide mode without steam or the water tank. In this mode, the oven keeps constant low temperatures inside the cooking chamber.				
	Air Fry	-	150-250	-	-	220
		Air Fry mode uses hot air for crispier and healthier frozen or fresh foods without, or less oil, than normal convection modes.				



Operations

Natural Steam (applicable models only)

With Natural Steam, you can bake bread that is crispy on the outside and moist inside. We recommend preheat the oven for the best results.

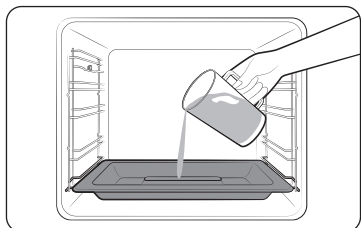

1. Insert steam tray on the bottom of compartment.
2. Fill the tray with water 250 mL only when the oven is cold.

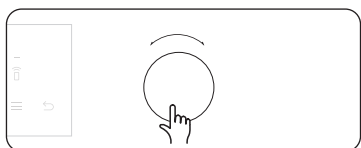

3. Select **Natural Steam** (☁️) mode.

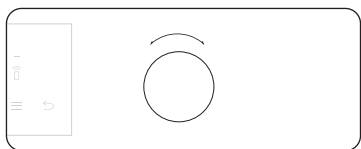

4. Turn the **Dial Knob** to set the temperature and cooking time.

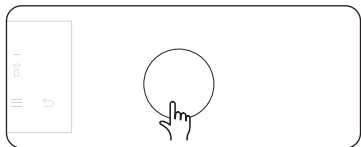

5. Press **Dial Knob** to start preheating.

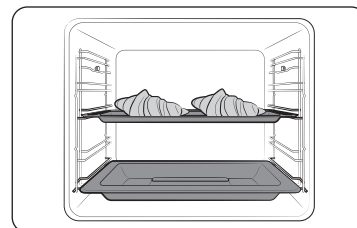

6. Put the food in the oven on any rack and start cooking.

NOTE

- Do not refill the water during cooking or when the oven is hot.
- When the oven cools down completely after using the **Natural Steam** function, use a wet cloth to wipe the bottom of the zone.
- To remove water scale that forms after using the oven for an extended time, use a soft cloth with dedicated detergent.

Food	Accessory	Level	Temp. (°C)	Time (min.)
Croissants, 4-6 pieces	Universal tray	3	190	20-25
Apple puff pastry	Universal tray	3	190	20-25
Danish pastry	Universal tray	3	190	20-30
Bread roll	Universal tray	3	180	20-30
White bread	Wire rack	2	180	30-40



Steam assisted modes

CAUTION

Make sure the water reservoir is filled before using the steam assisted modes.

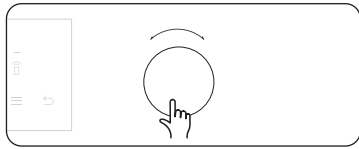

1. Select the desired cook mode, and then press the **Dial Knob**. (For detailed information of each mode, see “**Steam assisted mode descriptions**”).
 - You can use the meat probe in some modes. To cook using the meat probe, see “**Cooking with the meat probe (applicable models only)**”.

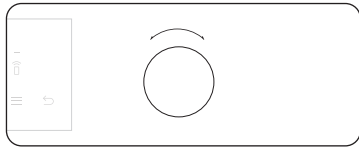

2. Set the desired temperature.
 - The default temperature and the temperature range differ depending on the cook mode.

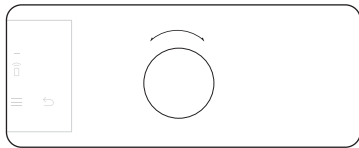

3. Set the steam level.
 - The default setting is “Medium”.

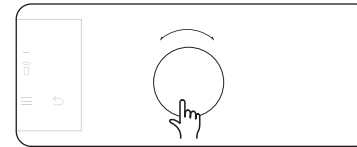

4. Select **Cook Time**, and then press the **Dial Knob** to set the desired cooking time.
 - Maximum cooking time is 23 hours and 59 minutes.
5. After setting the cooking time, select the option you want to run at the end of cooking, and then press the **Dial Knob**.



NOTE

If you start cooking without setting the cooking time for option, you must stop the oven manually.







6. Tap  to start cooking.

NOTE

- You can change the temperature and cooking time during cooking.
- During cooking, you can tap  to pause cooking, or tap  and hold for 3 seconds to stop and cancel the cooking operation.
- When cooking is complete, **Add 5 mins** appears on the screen.
 - You can select **Add 5 mins**, and then press the **Dial Knob** to extend the cooking for 5 more minutes.

Operations

Steam assisted mode descriptions

Mode	Temperature range (°C)	Default temperature (°C)	Fast Preheat	Meat probe
Steam Function				
 Steam Cook (*)	-	-	X	X
	The hot steam from the steam generator is injected through the steam nozzle into the oven to cook food. This mode is suitable for cooking vegetables, fish, eggs, fruits, and rice.			
 Steam Convection (*)	120-250	160	0	0
	The heat generated by the convection heater and fans is continuously supported by hot steam. The intensity of the steam can be adjusted to Low, Medium, or High. This mode is suitable for baking puff pastries, yeast cake, bread, and pizza and roasting meat and fish.			
 Steam Top Heat + Convection (*)	120-250	180	0	0
	The heat generated by the top heater and the convection heater is shared evenly in the oven by the fan, and the hot steam supports the heating elements. This mode is suitable for roasting crusty dishes like meat, poultry, or fish.			
 Steam Bottom Heat + Convection (*)	120-250	200	0	0
	The heat generated by the bottom heating element and the convection heater is shared evenly in the oven by the fan, and the hot steam supports the heating elements. This mode is suitable for crispy baking foods like pizza or apple pie.			

NOTE

- Availability of the modes with an asterisk (*) depends on the oven model.
- Always fill the water reservoir with fresh water when cooking with these modes.

Dual cook mode

You can use the provided divider to separate the cooking chamber in the upper and lower zones. This allows users to enable two different cooking modes simultaneously, or to simply choose one zone to cook with.

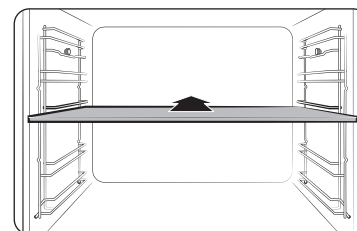

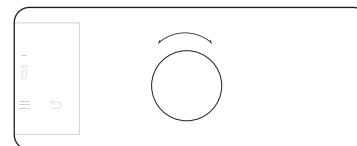

1. Insert the divider in level 3 to separate the cooking chamber in two zones.



2. Turn the **Dial Knob** to select the cooking mode. You can select Grill, Convection, Top heat + Convection and Air Fry mode on the upper zone and Convection, Bottom heat + Convection, and Bottom heat mode on the lower zone.



3. Tap  to select the upper zone, or tap  to select the lower zone. The  button activates for the selected zone.
4. Set the cooking time and/or temperature if necessary. See the **Common settings** section for details.

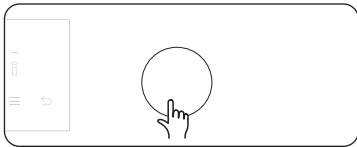

5. When done, press the **Dial Knob** to confirm.

The oven starts preheating with  icon until the internal temperature reaches the set temperature.

Preheating is recommended for all cooking modes unless otherwise specified in the cooking guide.

NOTE

Availability of Dual cook mode depends on the cooking mode. For more information, see the **Cooking smart** section in this manual.

Dual cook mode (Grill mode)

Grilling with Dual cook mode is useful for small serving sizes to save power. By default, only the Large grill option in the upper zone is available because the oven uses only the top heating element.

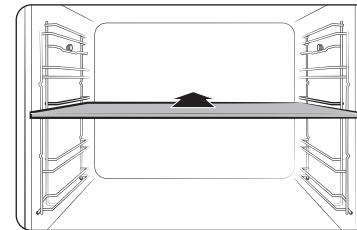

1. Insert the divider in level 3 to activate Dual cook mode.

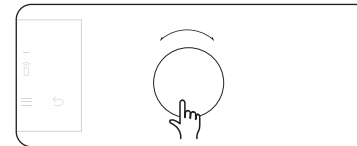

2. Turn the **Dial Knob** to select **Large Grill**, and then press the **Dial Knob** to confirm.
- Eco Grill and Fan Grill is not available in Dual cook mode.

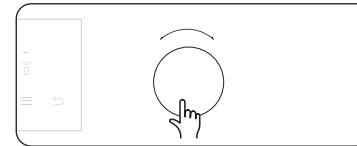

3. Turn the **Dial Knob** to set the desired temperature, and then press the **Dial Knob** to confirm.

Operations

Cooking with the meat probe (applicable models only)

The meat probe measures the internal temperature of meat while it's cooking. When the temperature reaches the target temperature, the oven stops and finishes cooking.

- Use only the meat probe that comes with your oven.
- You cannot set the cooking time if the meat probe is plugged in.

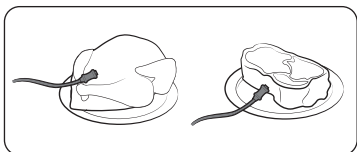

1. On the feature panel, tap to choose a cooking mode and temperature.
2. Insert the tip of the meat probe into the centre of the meat to cook. Make sure the rubber handle is not inserted.

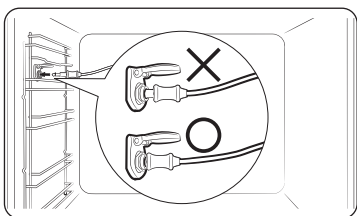

3. Plug the probe connector into the socket on the left side wall. Make sure you see the Meat Probe inserted indicator when the probe connector is connected.

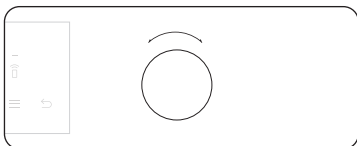

4. Turn the **Dial Knob** to set the internal temperature of the meat.

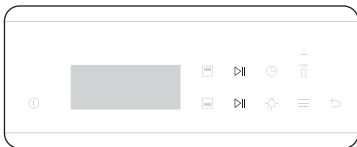

5. Tap **▶** to start cooking. The oven completes cooking with a melody when the internal temperature of the meat reaches the set temperature.

⚠ WARNING

- To prevent damage, do not use the meat probe with the spit accessory.
- When cooking is complete, the meat probe becomes very hot. To prevent burns, use oven gloves to take out the food.

📄 NOTE

Not all modes support using the meat probe. If you use the meat probe with inapplicable modes, the current mode indicator blinks. When this happens, remove the meat probe instantly.

Dual cook mode temperature setting range

You can use both the upper and lower zones simultaneously for different cooking operations.

In Dual Cook mode, the temperature range of one zone is affected by the temperature settings of the other zone. For instance, broiling in the upper zone will be limited by the operation in the lower zone in terms of cooking temperatures. However, either zone limits its temperature settings between minimum 40 and maximum 250.

If Upper is set to (°C)	Lower zone is limited to (°C)	
	Minimum	Maximum
40	40	45
60	50	75
80	65	105
100	80	135
120	90	160
140	105	190
160	120	220
180	135	250
200	145	250
220	160	250
250	170	250

If Lower is set to (°C)	Upper zone is limited to (°C)	
	Minimum	Maximum
40	40	45
60	50	75
80	65	105
100	80	135
120	90	160
140	105	190
160	120	220
180	135	250
200	145	250
220	160	250
250	170	250

Operations

Available modes in each zone

Zone	Available mode	Temperature range (°C)	Default temperature (°C)	Fast Preheat	Meat probe
Upper	Convection	40-250	160	X	X
	Large Grill	40-250	220	X	X
	Top Heat + Convection	40-250	180	X	X
	Air Fry	150-250	220	X	X
Lower	Convection	40-250	160	X	X
	Bottom Heat + Convection	40-250	200	X	X
	Bottom Heat	40-250	150	X	X
	Steam Cook (*)	-	-	X	X
	Steam Convection (*)	120-250	160	X	X
	Steam Bottom Heat + Convection (*)	120-250	200	X	X

NOTE

- Refer to “Cooking mode descriptions” or “Steam assisted mode descriptions” for description of each mode.
- Availability of the modes with an asterisk (*) depends on the oven model.

Air Fry (applicable models only)

Preheating is not necessary for this mode. We recommended place a baking sheet or tray on the divider for getting any drippings.
For better cooking results, flip food over during the process.

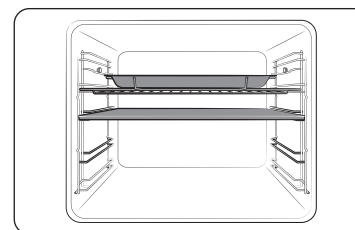

1. Insert divider and place the tray with wire rack on rack position 4.

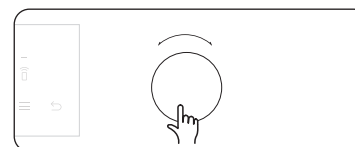

2. Select **Air Fry** mode using the **Dial Knob**.

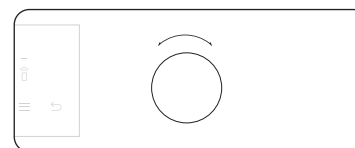

3. Use the **Dial Knob** to change the default temperature. Enter the suggested temperature for your food as recommended cooking guide. The default temperature is 220 °C.

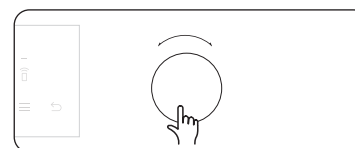

4. Press the **Dial Knob** and set the **Cook Time** or **End Time**, if necessary.

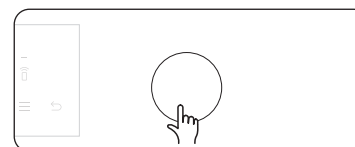

5. Tap **▶||** or press the **Dial Knob**.

NOTE

- Place a baking sheet or tray on the divider for getting any drippings. This will help to reduce splatter and smoke.
- Before using a baking sheet, check the maximum allowable temperature of baking sheet.
- **Air Fry** is designed for a dual upper oven rack. Insert divider and place food on rack position 4 for best results.
- For cooking fresh or homemade foods, spread the oil over a larger area more evenly, crisping up the food more effectively.

WARNING

- If anything is in progress in lower zone, **Air Fry** is not available in the upper zone.
- When **Air Fry** is in progress in the upper zone, the lower zone is not available at all.

We recommend turnover after half of cooking time for the best results.

Food	Accessory	Level	Temp. (°C)	Time (min.)
Potatoes				
Frozen French fries	Wire rack + Air Fry tray	4	210-220	20-25
Frozen French fries, seasoned	Wire rack + Air Fry tray	4	210-220	20-25
Frozen tater tots	Wire rack + Air Fry tray	4	210-220	15-20
Frozen hash brown	Wire rack + Air Fry tray	4	210-220	15-20
Frozen potato wedges	Wire rack + Air Fry tray	4	210-220	15-20
Homemade French fries	Wire rack + Air Fry tray	4	200-210	20-25
Homemade potato wedges	Wire rack + Air Fry tray	4	210-220	20-25
Frozen				
Frozen chicken nuggets	Wire rack + Air Fry tray	4	210-220	15-20
Frozen chicken wings	Wire rack + Air Fry tray	4	210-220	25-30
Frozen onion rings	Wire rack + Air Fry tray	4	210-220	15-20
Frozen chicken strips	Wire rack + Air Fry tray	4	210-220	20-25
Frozen Churros	Wire rack + Air Fry tray	4	190-200	10-15

Operations

Food	Accessory	Level	Temp. (°C)	Time (min.)
Chicken				
Fresh drumsticks	Wire rack + Air Fry tray	4	200-210	30-35
Fresh wings	Wire rack + Air Fry tray	4	200-210	25-30
Breasts, breaded	Wire rack + Air Fry tray	4	200-210	25-30
Vegetable				
Asparagus, breaded	Wire rack + Air Fry tray	4	200-210	15-20
Aubergine, sliced and breaded	Wire rack + Air Fry tray	4	200-210	15-20
Onion rings, breaded	Wire rack + Air Fry tray	4	200-210	15-20
Squash cubes	Wire rack + Air Fry tray	4	200-210	20-25
Cauliflower florets	Wire rack + Air Fry tray	4	190-200	15-20
Vegetable mix	Wire rack + Air Fry tray	4	200-210	15-20

Air Sous Vide (applicable models only)

Air Sous Vide mode uses low-temperature hot air to implement Sous Vide mode without steam or the water tank. In this mode, the oven keeps constant low temperatures inside the cooking chamber, cooking food that can keep its original fragrance and nutrients while offering enriched flavor and soft texture.



- Put food in a clean vacuum bag and seal it up. Then, load the food in rack position 3 of the oven.

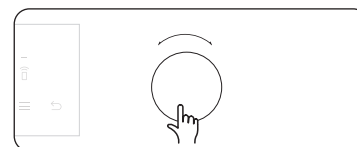
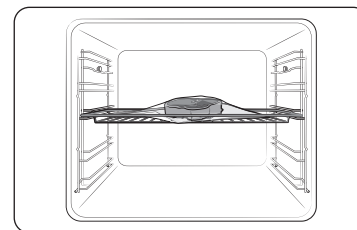

- Select **Air Sous Vide** mode.

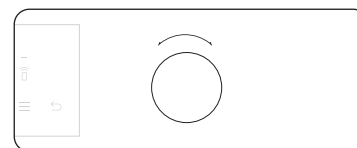

- Use the **Dial Knob** to change the default temperature. Enter the suggested temperature for your food as recommended cooking guide. The default temperature is 60 °C. (You can change the temperature by 1 °C)

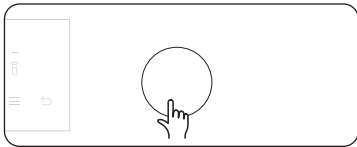

4. Press the **Dial Knob** and set the cooking time.

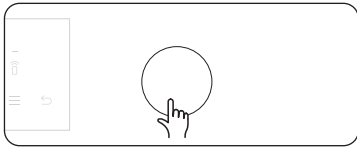

5. Tap **▶||** or press the **Dial Knob**.

NOTE

- Use fresh and quality ingredients only. Trim them in a clean condition and store under refrigeration.
- Use heat-resistant vacuum bags for moving and storing ingredients.
- Do never reuse the heat-resistant vacuum bags.
- The cooking time depends on the thickness of food. Addition of salt or sugar may shorten the cooking time.

Tips

- To keep the original taste, we recommend you use less herbs and spices than in ordinary recipes.
- Meat and fishery offer better flavors when seared and served.
- If not served immediately after cooked, put the food in ice water and cool down completely. Then, store them under 5 °C to keep the fragrance and texture of food.
- Exceptionally, chicken is recommended to eat immediately after cooked.

We recommended preheat the oven for the best results.

Food	Doneness	Accessory	Level	Temp. (°C)	Time (hrs.)
Beef					
Steak, 4cm thick	Rare	Wire rack	3	54	3-4
Steak, 4cm thick	Medium	Wire rack	3	60	3-4
Steak, 4cm thick	Well done	Wire rack	3	68	3-4
Roast	Medium	Wire rack	3	62	6-8
Roast	Well done	Wire rack	3	68	6-8
Pork					
Chop, boneless	Tender	Wire rack	3	60	3-4
Chop, boneless	Firm	Wire rack	3	71	3-4
Roast	Medium	Wire rack	3	62	4-6
Roast	Well done	Wire rack	3	72	4-6
Pulled pork	Well done	Wire rack	3	74	18-24
Poultry					
Chicken, breast	Tender	Wire rack	3	66	3-4
Chicken, breast	Firm	Wire rack	3	72	3-4
Duck, breast	Tender	Wire rack	3	63	3-4
Fish					
Salmon steak	Tender	Wire rack	3	52	2-3
Salmon steak	Well done	Wire rack	3	63	2-3
Cod fillet	Tender	Wire rack	3	55	2-3

Operations

Food	Doneness	Accessory	Level	Temp. (°C)	Time (hrs.)
Vegetables					
Asparagus	-	Wire rack	3	85	2-3
Potato, sliced	-	Wire rack	3	90	2-3
Sweet potato, sliced	-	Wire rack	3	90	2-3
Carrot, sliced	-	Wire rack	3	90	2-3
Squash, cubes	-	Wire rack	3	90	2-3
Fruit					
Apple, sliced	-	Wire rack	3	80	2-3
Pineapple, sliced	-	Wire rack	3	85	1-2
Pear, sliced	-	Wire rack	3	83	2-3
Others					
Hen's eggs	Poached	Wire rack	3	63	2-3
Hen's eggs	Hard boiled	Wire rack	3	71	2-3

* Cook hen's eggs without vacuum sealing.

To stop cooking

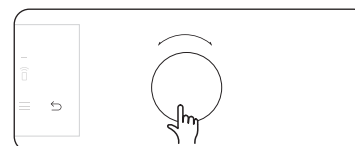

- While cooking is in process, you can tap **▷||** button to turn the oven off. However, the oven will not turn off immediately to avoid any unintended manipulation. If you tap **▷||** button by mistake, you can tap **▷||** button on within 3 seconds.
- You can tap **▷||** to pause cooking, or tap and hold **▷||** for 3 seconds to stop and cancel the cooking operation.
- Alternatively, you can tap **↶**, use the **Dial Knob** to select **Yes**, and then press the **Dial Knob** to cancel the cooking operation.

To stop cooking for an individual zone

Follow these instructions to stop cooking in Dual cook mode.

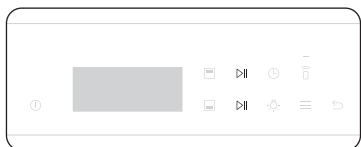

- You can tap to pause cooking, or tap and hold for 3 seconds to stop and cancel the cooking operation.
 - Tap the upper button for the upper zone, and the lower button for the lower zone.

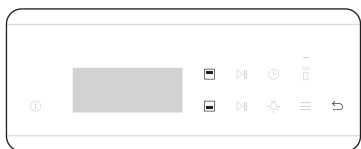

- Alternatively, you can follow the below instructions.
 - tap to select the upper zone or tap to select the lower zone, and then tap .

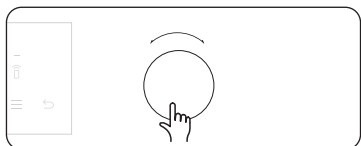

- Turn the **Dial Knob** to select **Yes**, and then press the **Dial Knob** to cancel the cooking operation.

Special Function

Additional functions improve your cooking experience. Special functions are not enabled in Dual cook mode.

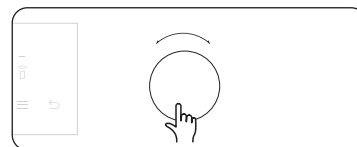

- Turn the **Dial Knob** to select **Special Function** and press the **Dial Knob** to confirm.

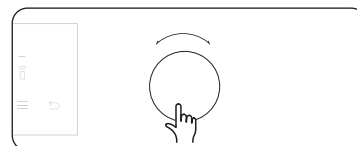

- Turn the **Dial Knob** to select a function, and then press the **Dial Knob** to confirm.
- Set the cooking time and/or temperature if necessary. See the **Common settings** section for details.

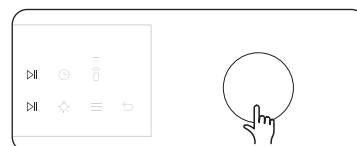

- Press the **Dial Knob** or tap button to start the function.

Mode	Temperature range (°C)	Suggested temperature (°C)	Instructions
Keep warm	40-100	60	Use this only for keeping foods warm that just have been cooked.
Plate warm	30-80	50	Use this for warming dishes or ovenware.
Defrost	30-60	30	This mode uses for defrosting frozen products, baking goods, fruit, cake, cream and chocolate. The defrosting time is depending on the type, size and quantity of the food.

Operations

Auto Cook

For inexperienced cooks, the oven offers a total of 50 auto cooking recipes. Take advantage of this feature to save you time or shorten your learning curve. The cooking time and temperature will be adjusted according to the selected recipe.

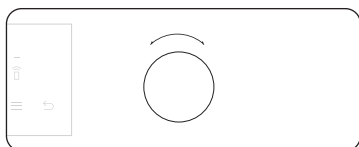

1. Turn the **Dial Knob** to select **Auto Cook**.

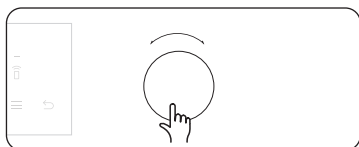

2. Turn the **Dial Knob** to select a programme, and then press the **Dial Knob** to confirm.

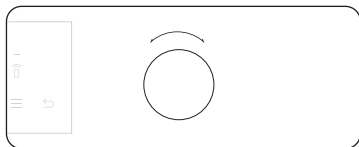

3. Turn the **Dial Knob** to select a serving size. The weight range depends on the programme.

4. Press the **Dial Knob** or tap **▶||** button to start cooking.

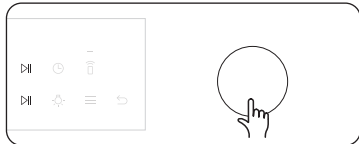

NOTE

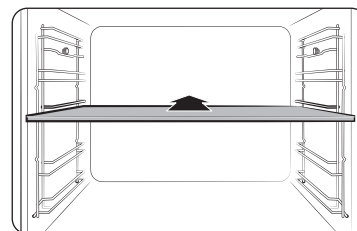

- Some of the items in the Auto cook programmes include preheating. For those items, the preheating progress is displayed. Please put the food in the oven after preheating beep. Then, press the **Dial Knob** or tap **▶||** button to start Auto Cook.
- For more information, see the **Cooking smart** section in this manual.

Dual cook mode



1. Insert the divider in level 3 to activate Dual cook mode.



2. Tap  to select the upper zone or tap  to select the lower zone. The **▶||** button activates for the selected zone.

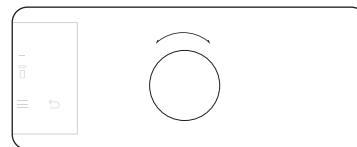

3. Turn the **Dial Knob** to select **Auto Cook**.

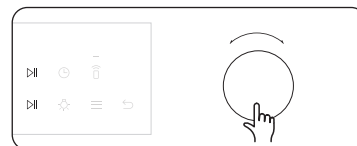

4. Turn the **Dial Knob** to select a programme for the selected zone, and then press the **Dial Knob** or tap **▶||** button.

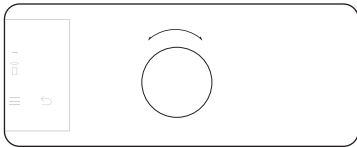

5. Turn the **Dial Knob** to select a serving size. The weight range depends on the programme.

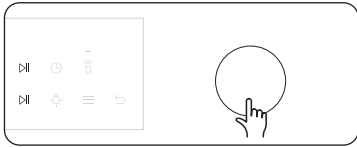

6. Press the **Dial Knob** or tap ▷|| button to start cooking.

NOTE

For more information, see the **Cooking smart** section in this manual.

Cleaning

Two cleaning modes are available for you. This function saves you time by removing the need for regular manual cleaning. The remaining time appears on the display during this process.

Function	Instructions
Steam Clean	This is useful for cleaning light soiling with steaming.
Pyrolytic	Pyrolytic features high temperature thermal cleaning. It burns off oily leftovers to facilitate manual cleaning. 1 h 50 m / 2 h 10 m (default setting) / 2 h 30 m
Descale	Clean inside the steam generator to prevent affecting the food quality and taste.
Drain	After using the steam assisted modes, you must drain the remaining water to prevent affecting other cooking modes.

Pyrolytic (applicable models only)

Pyrolytic features high temperature thermal cleaning. It burns off oily leftovers to facilitate manual cleaning.

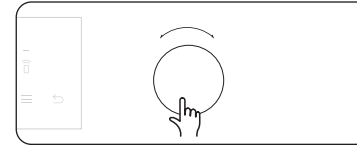

1. Remove all accessories, including the side runners, and wipe out large pieces of impurities manually from inside the oven. Otherwise, they may cause flames during the cleaning cycle, resulting in a fire.
2. Turn the **Dial Knob** to select **Cleaning** and then press the **Dial Knob** to confirm.

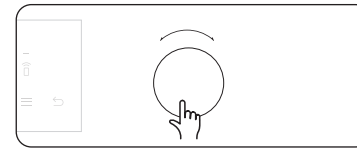

3. Turn the **Dial Knob** to select **Pyrolytic**, and then press the **Dial Knob** to confirm.

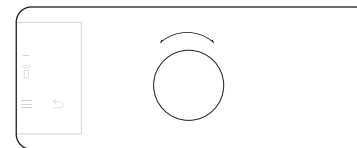

4. Turn the **Dial Knob** to select a cleaning time from 3 levels: 1 hr 50 min, 2 hr 10 min (default setting), and 2 hr 30 min.

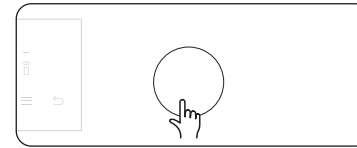

5. Press the **Dial Knob** to start cleaning.

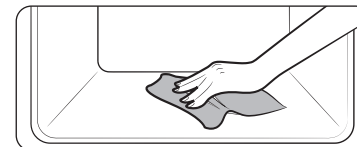

6. When complete, wait until the oven cools down, and then wipe the door along its edges using a wet cloth.

Operations

⚠ CAUTION

- Do not touch the oven because the oven becomes very hot during the cycle.
- To avoid accidents, keep children away from the oven.
- After the cycle is complete, do not power off while the cooling fan is operating to cool the oven down.

📖 NOTE

- Once the cycle starts, the oven becomes hot inside. Then, the door will be locked for safety. When the cycle is complete and the oven cools down, the door will be unlocked.
- Make sure you empty the oven before cleaning. Accessories can be deformed due to high temperatures inside the oven.

Steam Clean

This is useful for cleaning light soiling with steaming.

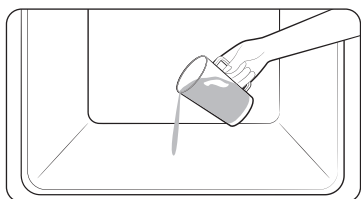

1. Pour 400 ml (3/4 pint) of water onto the bottom of the oven and close the oven door.

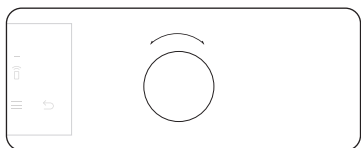

2. Turn the **Dial Knob** to select **Cleaning**.

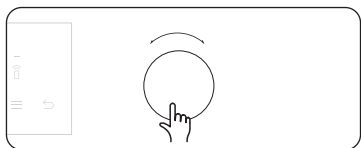

3. Turn the **Dial Knob** to select **Steam Clean**, and then press the **Dial Knob** to start cleaning. Steam cleaning runs for 26 minutes.

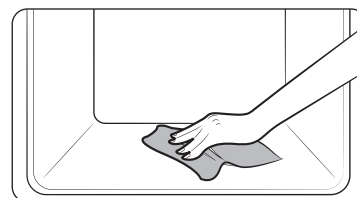

4. Use a dry cloth to clean inside the oven.

⚠ WARNING

Do not open the door before the cycle is complete. The water inside the oven is very hot, and it can cause a burn.

📖 NOTE

- If the oven is heavily soiled with grease, for example, after roasting or grilling, it is recommended to remove stubborn soils manually using a cleaning agent before activating Steam cleaning.
- Leave the oven door ajar when the cycle is complete. This is to allow the interior enamel surface to dry thoroughly.
- If the oven is hot inside, cleaning is not activated. Wait until the oven cools down, and try again.
- Do not pour water onto the bottom by force. Do it gently. Otherwise, the water overflows to the front.

Descal

Clean inside the steam generator to prevent affecting the food quality and taste.

NOTE

The oven counts the time of steam assisted modes and notifies you to run the Descal function when required. You can still use the steam assisted modes for the next two hours without running the Descal function. However, you cannot use the steam assisted modes after two hours unless you run and complete the Descal function.

1. Touch the  **Dial Knob** to select Cleaning.
2. And then press the **Dial Knob**.
3. Select **Descal**, and then press the **Dial Knob**.
4. Select **Next**, and then press the **Dial Knob**.
5. Follow the instruction on the screen, select **Start**, and then press the **Dial Knob**.
 - If you get a notification message that you have insufficient water, add more water in the water reservoir, select **OK**, and then press the **Dial Knob**.
6. When descaling is complete, the oven drains water automatically.
7. Once draining is complete, empty the water reservoir.
8. Refill the water reservoir with 500 ml of drinkable water as instructed on the screen, select **OK**, and then press the **Dial Knob** to start rinsing.
9. When rinsing is complete, empty the water reservoir.
 - After emptying the reservoir, clean it before putting it back to the oven.

WARNING

- Wear oven gloves when you handle the water reservoir.
- Use only descaling agents that are specific to steam ovens or coffee machines.

CAUTION

- Do not cancel descaling in the process. Otherwise, you must restart the descaling cycle and complete within the next three hours in order to enable steam assisted modes.
- To avoid accidents, keep children away from the oven.
- For the mixture ratio of water and the descaling agent, follow the agent manufacturer's instruction as it precedes.

Drain

After using the steam assisted modes, you must drain the remaining water to prevent affecting other cooking modes. Also, if you want to drain again for cleaning purposes, use this function.

1. Turn the **Dial Knob** to select Cleaning.
2. And then press the **Dial Knob**.
3. Select **Drain**, and then press the **Dial Knob**.
4. Select **Start**, and then press the **Dial Knob**.
5. Follow the instruction on the screen, select **OK**, and then press the **Dial Knob**.
 - The oven drains water from the steam generator to the water reservoir.
6. When draining is complete, empty the water reservoir.
 - After emptying the reservoir, clean it before putting it back to the oven.

WARNING



- Wear oven gloves when you handle the water reservoir.
- Do not remove the water reservoir while draining.

NOTE

- Once the oven starts draining, please wait until the draining cycle is complete.
- Depending on the product's environment, the drain operation may take a long time. It's not a product malfunction, it's for safety, so wait for the water to cool down.

Operations

More Functions



Menu	Description
Timer	You can set the timer.
Lock	You can lock the control panel.
My Modes	You can edit the cooking mode list.
Screen timeout	You can adjust the display timeout.
Auto date & time	You can set the Auto date & time.
Set date	You can set the current date.  NOTE For detailed instruction, see page 10
Time format	You can set the time format to 12-hour or 24-hour format.  NOTE For detailed instruction, see page 10.
Sound	You can turn the oven's sound (beeps) on or off.
Fast Preheat (*)	You can set the Fast Preheat.

(*) applicable models only.



Timer

1. Tap .
2. Select **Timer** using the **Dial Knob**, and then press **Dial Knob**.
3. Set the timer (hour and minute) using the **Dial Knob**, and then press **Dial Knob**.
4. Press **Dial Knob** to start the timer.
5. If you want to pause, cancel, or edit timer, press **Dial Knob** or turn the **Dial Knob**.

Lock

1. Tap .
2. Select **Lock** using the **Dial Knob**, and then press **Dial Knob**.
3. If you want to unlock the control panel, tap and hold  for 3 seconds.

My Modes

1. Tap .
2. Select **My Modes** using the **Dial Knob**, and then press **Dial Knob**.
3. Turn the **Dial Knob**, and then press **Dial Knob** to select or unselect modes.
4. Tap  to save.
5. Select **Save** to save the changes.

Screen timeout

1. Tap .
2. Select **Screen timeout** using the **Dial Knob**, and then press **Dial Knob**.
3. Turn the **Dial Knob** to select the desired time.
4. Press **Dial Knob** to save the changes.

Auto date and time

1. Tap .
2. Select **Auto date & time** using the **Dial Knob**, and then press **Dial Knob**.
3. Turn the **Dial Knob** to select **On** or **Off**.
4. Press **Dial Knob** to save the changes.

Sound

1. Tap .
2. Select **Sound** using the **Dial Knob**, and then press **Dial Knob**.
3. Turn the **Dial Knob** to select **On** or **Off**.
4. Press **Dial Knob** to save the changes.

Fast Preheat

1. Tap .
2. Select **Fast Preheat** using the **Dial Knob**, and then press **Dial Knob**.
3. Turn the **Dial Knob** to select **On** or **Off**.
4. Press **Dial Knob** to save the changes.

System Settings

Tap and hold  for 3 seconds to enter the **System Settings** menu, and then turn the **Dial Knob** to change various settings for your oven.

Please refer to the following table for detailed descriptions.

System Setting	Description
Wi-Fi	You can turn the Wi-Fi on or off.
Language	You can select a language.
My Patterns	This function remembers and stores the cook settings.
Default Cavity	You can select upper or lower oven as your default setting. (Dual cook mode only)
Water hardness	You can select the Water hardness.
Reset	Reset your setting. (More Functions, System settings)

Wi-Fi / My Patterns

1. Tap and hold  for 3 seconds to enter the **System Settings** menu.
2. Select the desired menu using the **Dial Knob**, and then press **Dial Knob**.
3. Turn the **Dial Knob** to select **On** or **Off**.
4. Press **Dial Knob** to save the changes.

Language

1. Tap and hold  for 3 seconds to enter the **System Settings** menu.
2. Select **Language** using the **Dial Knob**, and then press **Dial Knob**.
3. Turn the **Dial Knob** to select the desired language.
4. Press **Dial Knob** to save the changes.

Default Cavity

1. Tap  and hold for 3 seconds to enter the **System Settings** menu.
2. Select Default Cavity using the **Dial Knob**, and then press **Dial Knob**.
3. Turn the **Dial Knob** to select **Upper** or **Lower**.
4. Press **Dial Knob** to save the changes.

Water hardness

1. Tap  and hold for 3 seconds to enter the **System Settings** menu.
2. Select **Water hardness** using the **Dial Knob**, and then press **Dial Knob**.
3. Turn the **Dial Knob** to select the desired **Water hardness**.
4. Press **Dial Knob** to save the changes.



Reset

1. Tap and hold  for 3 seconds to enter the **System Settings** menu.
2. Select **Reset** using the **Dial Knob**, and then press **Dial Knob**.
3. Turn the **Dial Knob** to select **Reset** or **Cancel**.
4. press **Dial Knob** to confirm.

Smart Control

To use the oven's Smart Control, you must download the SmartThings app to a mobile device. Functions operated by the SmartThings app may not work smoothly if communication conditions are poor or the oven is installed in a place with a weak Wi-Fi signal.

How to connect the oven

1. Download and open the SmartThings app on your mobile device.
2. Follow the app's on-screen instructions to connect your oven.
3. Once the process is complete, the  icon located on your oven display, and the app will confirm you are connected.
4. If the  icon does not appear, follow the instruction on the app to reconnect.

Cooking smart

Manual cooking

⚠ WARNING on acrylamide

Acrylamide produced while baking starch-contained food such as potato chips, French fries, and bread may cause health problems. It is recommended to cook these foods at low temperatures and avoid overcooking, heavy crisping, or burning.

📖 NOTE

- Pre-heating is recommended for all cooking modes unless otherwise specified in the cooking guide.
- When using Eco Grill, put food in the centre of the accessory tray.













Accessory tips



Your oven comes with a different number or kind of accessories. You may find that some accessories are missing from the table below. However, even if you are not provided with the exact accessories specified in this cooking guide, you can follow along with what you already have, and achieve the same results.

- The Baking tray and the Universal tray are interchangeable.
- When cooking oily foods, it is recommended to put a tray under the Wire rack to collect oil residue. If you are provided with the Wire rack insert, you can use it together with the tray.
- If you are provided with the Universal tray or Extra deep tray, or both, it is better to use whichever is deeper for cooking oily foods.





Baking









We recommend to preheat the oven for best results.

Food	Accessory	Level	Type of heating	Temp. (°C)	Time (min.)
Sponge cake	Wire rack, Ø 25-26 cm tin	2		160-170	35-40
Marble cake	Wire rack, Gugelhopf tin	3		175-185	50-60
Tart	Wire rack, Ø 20 cm tart tin	3		190-200	50-60
Yeast cake on tray with fruits and crumbles	Universal tray	2		160-180	40-50
Fruit crumble	Wire rack, 22-24 cm oven dish	3		170-180	25-30
Scones	Universal tray	3		180-190	30-35
Lasagne	Wire rack, 22-24 cm oven dish	3		190-200	25-30
Meringues	Universal tray	3		80-100	100-150
Soufflé	Wire rack, soufflé cups	3		170-180	20-25
Apple yeast tray cake	Universal tray	3		150-170	60-70
Homemade pizza, 1-1.2kg	Universal tray	2		190-210	10-15
Frozen puff pastry, filled	Universal tray	2		180-200	20-25
Quiche	Wire rack, 22-24 cm oven dish	2		180-190	25-35

Food	Accessory	Level	Type of heating	Temp. (°C)	Time (min.)
Apple pie	Wire rack, Ø 20 cm tin	2		160-170	65-75
Chilled pizza	Universal tray	3		180-200	5-10

Roasting

Food	Accessory	Level	Type of heating	Temp. (°C)	Time (min.)
Meat(Beef/Pork/Lamb)					
Sirloin of beef, 1 kg	Wire rack + Universal tray	3 1		160-180	50-70
Boned loin of veal, 1.5 kg	Wire rack + Universal tray	3 1		160-180	90-120
Pork roast, 1 kg	Wire rack + Universal tray	3 1		200-210	50-60
Joint of pork, 1 kg	Wire rack + Universal tray	3 1		160-180	100-120
Leg of lamb on the bone, 1 kg	Wire rack + Universal tray	3 1		170-180	100-120









Food	Accessory	Level	Type of heating	Temp. (°C)	Time (min.)
Poultry(Chicken/Duck/Turkey)					
Chicken, Whole, 1.2 kg *	Wire rack + Universal tray (to catch drippings)	3 1		205	80-100*
Chicken pieces	Wire rack + Universal tray	3 1		200-220	25-35
Duck breast	Wire rack + Universal tray	3 1		180-200	20-30
Small turkey, whole, 5 kg	Wire rack + Universal tray	3 1		180-200	120-150
Vegetables					
Vegetables, 0.5 kg	Universal tray	3		220-230	15-20
Baked potato halves, 0.5 kg	Universal tray	3		200	45-50
Fish					
Fish fillet, baked	Wire rack + Universal tray	3 1		200-230	10-15
Roast fish	Wire rack + Universal tray	3 1		180-200	30-40

* Turnover after half of time.

Cooking smart









Grilling

We recommend preheat the oven using large grill mode. Turn over after half of time.

Food	Accessory	Level	Type of heating	Temp. (°C)	Time (min.)
Bread					
Toast	Wire rack	5		270	2-4
Cheese toast	Universal tray	4		200	4-8
Beef					
Steak *	Wire rack + Universal tray	4 1		240-250	15-20
Burgers *	Wire rack + Universal tray	4 1		250-270	13-18
Pork					
Pork chops	Wire rack + Universal tray	4 1		250-270	15-20
Sausages	Wire rack + Universal tray	4 1		260-270	10-15
Poultry					
Chicken, breast	Wire rack + Universal tray	4 1		230-240	30-35
Chicken, drumstick	Wire rack + Universal tray	4 1		230-240	25-30

* Turnover after $\frac{2}{3}$ of the cooking time.

Frozen ready-meal

Food	Accessory	Level	Type of heating	Temp. (°C)	Time (min.)
Frozen pizza, 0.4-0.6 kg	Wire rack	3		200-220	15-25
Frozen lasagne	Wire rack	3		180-200	45-50
Frozen oven chips	Universal tray	3		220-225	20-25
Frozen Croquettes	Universal tray	3		220-230	25-30
Frozen oven camembert	Wire rack	3		190-200	10-15
Frozen baguettes with topping	Wire rack + Universal tray	3 1		190-200	10-15
Frozen fish fingers	Wire rack + Universal tray	3 1		190-200	15-25
Frozen fish burger	Wire rack	3		180-200	20-35

Pro-Roasting

This mode includes an automatic heating-up cycle up to 220 °C. The top heater and the convection fan are operating during the process of searing the meat. After this stage the food is cooked gently by the low temperature of pre-selection. This process is done while the top and the bottom heaters are operating. This mode is suitable for meat roasts and poultry.

Food	Accessory	Level	Temp. (°C)	Time (hrs.)
Roast beef	Wire rack + Universal tray	3 1	80-100	3-4
Pork roast	Wire rack + Universal tray	3 1	80-100	4-5
Lamb roast	Wire rack + Universal tray	3 1	80-100	3-4
Duck breast	Wire rack + Universal tray	3 1	80-100	2-3

ECO convection

This mode uses the optimized heating system so that you save the energy during cooking your dishes. The times of this category are suggested to not be preheated before cooking for saving more energy.

You can increase or decrease the cooking time and/or temperature to your preference.

Food	Accessory	Level	Temp. (°C)	Time (min.)
Fruit crumble, 0.8-1.2 kg	Wire rack	2	160-180	60-80
Jacket potatoes, 0.4-0.8 kg	Universal tray	2	190-200	70-80
Sausages, 0.3-0.5 kg	Wire rack + Universal tray	3 1	160-180	20-30
Frozen oven chips, 0.3-0.5 kg	Universal tray	3	180-200	25-35
Frozen potato wedges, 0.3-0.5 kg	Universal tray	3	190-210	25-35
Fish fillets, baked, 0.4-0.8 kg	Wire rack + Universal tray	3 1	200-220	30-40
Crispy fish fillets, breaded, 0.4-0.8 kg	Wire rack + Universal tray	3 1	200-220	30-45
Roast sirloin of beef, 0.8-1.2 kg	Wire rack + Universal tray	2 1	180-200	65-75
Roast vegetables, 0.4-0.6 kg	Universal tray	3	200-220	25-35











Cooking smart

Dual cook

Before using dual cook function insert the divider into the oven. We recommend preheat the oven for best results.





The following table presents 5 dual cook guides we recommended for cooking, roasting and baking. Using dual cook function, you will be able to cook your main dish & side dish or main dish & dessert simultaneously.

- Using dual cook function, preheating time can be extended.

No	Zone	Food	Accessory	Level	Type of heating	Temp. (°C)	Time (min.)
1	Upper	Sponge cake	Wire rack, Ø 25-26 cm tin	4		160-170	40-45
	Lower	Homemade pizza, 1.0-1.2 kg	Universal tray	1		190-210	13-18
2	Upper	Roast vegetables, 0.4-0.8 kg	Universal tray	4		220-230	13-18
	Lower	Apple pie	Wire rack, Ø 20 cm tin	1		160-170	70-80
3	Upper	Pita bread	Universal tray	4		230-240	13-18
	Lower	Potato gratin, 1.0-1.5 kg	Wire rack, 22-24cm oven dish	1		180-190	45-50
4	Upper	Chicken, drumstick	Wire rack + universal tray	4 4		210-230	30-35
	Lower	Lasagne, 1.0-1.5 kg	Wire rack, 22-24cm oven dish	1		190-200	30-35
5	Upper	Fish fillet, baked	Wire rack + Universal tray	4 4		210-230	15-20
	Lower	Apple puff pastry	Universal tray	1		170-180	25-30





You can also use upper or lower zone only to save power. The cooking time can be extended when you use separated zone. We recommend preheat the oven for best results.

Upper

Food	Accessory	Level	Type of heating	Temp. (°C)	Time (min.)
Small cakes	Universal tray	4		170	30-35
Scones	Universal tray	4		180-190	30-35
Lasagne	Wire rack	4		190-200	30-35
Chicken, drumstick*	Wire rack + Universal tray	4 4		230-250	30-35

* Do not preheat the oven.

Lower

Food	Accessory	Level	Type of heating	Temp. (°C)	Time (min.)
Small cakes	Universal tray	1		170	30-35
Marble cake	Wire rack	1		160-170	60-70
Apple pie	Wire rack	1		160-170	70-80
Homemade pizza, 1.0-1.2 kg	Universal tray	1		190-210	13-18

Auto cook programmes

⚠ CAUTION

Foods that can easily spoil (such as milk, eggs, fish, meat, or poultry) should not stand in the oven for more than 1 hour before cooking begins, and should be removed promptly when cooking is completed. Eating spoiled food can result in sickness from food poisoning.

Single cook

The following table presents 40 auto programmes for cooking, roasting and baking.

It contains its quantities, weight ranges and appropriate recommendations. Cooking modes and times have been pre-programmed for your convenience. You will find some recipes for the auto programmes in your instruction book.

Auto cook programmes 1 to 19, 38 and 39 include preheating and display the preheating progress. Please put the food in the oven after preheating beep. Then, press the **Dial Knob** or tap **▶||** button to start Auto Cook.

⚠ WARNING

Always use oven gloves while taking out food.

Code	Food	Weight (kg)	Accessory	Level
1	Potato gratin	1.0-1.5	Wire rack	3
		Prepare fresh potato gratin using an ovenproof dish, 22-24 cm. Start programme, after preheating beep sounds, put dish on the centre of rack.		
2	Vegetable gratin	0.8-1.2	Wire rack	3
		Prepare fresh vegetable gratin using an ovenproof dish, 22-24 cm. Start programme, after preheating beep sounds, put dish on the centre of rack.		

Code	Food	Weight (kg)	Accessory	Level
3	Pasta bake	1.2-1.5	Wire rack	3
		Prepare pasta gratin using 22-24 cm ovenproof dish. Start programme, after preheating beep sounds, put dish on the centre of rack.		
4	Lasagne	1.0-1.5	Wire rack	3
		Prepare homemade lasagna using 22-24 cm ovenproof dish. Start programme, after preheating beep sounds, put dish on the centre of rack.		
5	Ratatouille	1.2-1.5	Wire rack	3
		Put ingredients for Ratatouille in casserole dish with lid. Start programme, after preheating beep sounds, put dish on the centre of rack. Bake covered. Stir before serving.		
6	Apple pie	1.2-1.4	Wire rack	2
		Prepare apple pie using a 20-24 cm round metal baking tin. Start programme, after preheating beep sounds, put tin on the centre of rack.		
7	Croissants	0.3-0.4	Universal tray	3
		Prepare croissants (chilled ready dough). Put on baking paper on universal tray. Start programme, after preheating beep sounds, put tray into the oven.		
8	Apple puff pastry	0.3-0.4	Universal tray	3
		Put apple puff pastries on baking paper on universal tray. Start programme, after preheating beep sounds, put tray into the oven.		

Cooking smart

Code	Food	Weight (kg)	Accessory	Level
9	Fruit flan base	0.4-0.5	Wire rack	3
		Put the dough into a black metal buttered baking dish for cake base. Start programme, after preheating beep sounds, put tin on the centre of rack.		
10	Quiche Lorraine	1.2-1.5	Wire rack	2
		Prepare quiche dough, put in a round quiche dish with 25 cm diameter. Start programme, after preheating beep sounds add filling and put dish on the centre of rack.		
11	White bread loaf	0.6-0.7	Wire rack	2
		Prepare dough and put into a black metal rectangular baking dish (length 25 cm). Start programme, after preheating beep sounds put dish on the centre of rack.		
12	Mixed grain bread loaf	0.8-0.9	Wire rack	2
		Prepare dough and put into a black metal rectangular baking dish (length 25 cm). Start programme, after preheating beep sounds put dish on the centre of rack.		
13	Bread roll	0.3-0.5	Universal tray	3
		Prepare rolls (chilled ready dough). Put on baking paper on universal tray. Start programme, after preheating beep, put tray into the oven.		

Code	Food	Weight (kg)	Accessory	Level
14	Fruit crumbles	0.8-1.2	Wire rack	3
		Put fresh fruits (raspberries, blackberries, apple slices, or pear slices) into oven dish 22-24 cm. Distribute crumbles on top. Start programme, after preheating beep sounds, put dish on the centre of rack.		
15	Scones	0.5-0.6	Universal tray	3
		Put scones (5-6 cm diameter) on baking paper on universal tray. Start programme, after preheating beep sounds, put tray into the oven.		
16	Sponge cake	0.5-0.6	Wire rack	3
		Prepare cake batter and put into a black metal round baking tin with 26 cm diameter. Start programme, after preheating beep sounds, put tin on the centre of rack.		
17	Marble cake	0.7-0.8	Wire rack	2
		Prepare cake batter and put into a metal round gugelhupf or bundt tin. Start programme, after preheating beep sounds, put tin on the centre of rack.		
18	Dutch loaf cake	0.7-0.8	Wire rack	2
		Prepare cake batter and put into a black metal rectangular baking dish (length 25 cm). Start programme, after preheating beep sounds, put tin on the centre of rack.		
19	Brownies	0.7-0.8	Wire rack	3
		Prepare cake batter using a 20-24 cm ovenproof dish. Start programme, after preheating beep sounds, put dish on the centre of rack.		

Code	Food	Weight (kg)	Accessory	Level
20	Roast sirloin of beef	0.8-1.2	Wire rack	2
			Universal tray	1
Season the beef and leave in refrigerator for 1 hour. Put on the wire-rack with fat-side up.				
21	Slow Cooked Roast Beef	0.8-1.2	Wire rack	2
			Universal tray	1
Season the beef and leave in refrigerator for 1 hour. Put on the wire-rack with fat-side up.				
22	Herb Roasted Lamb Chops	0.4-0.8	Wire rack	4
			Universal tray	1
Marinate the lamb chops with herbs and spices and put them on wire rack.				
23	Leg of Lamb on the bone	1.0-1.4	Wire rack	3
			Universal tray	1
Marinate the lamb and put on wire rack.				
24	Roast Pork with Crackling	0.8-1.2	Wire rack	3
			Universal tray	1
Put pork roast with fat side to the top on wire rack.				
25	Rack of Pork Ribs	0.8-1.2	Wire rack	3
			Universal tray	1
Put rack of pork rib on rack.				

Code	Food	Weight (kg)	Accessory	Level
26	Chicken, Whole	1.0-1.4	Wire rack	2
			Universal tray	1
Rinse and clean chicken. Brush chicken with oil and spices. Put it breast side down on the rack and turn over as soon as the oven beeps.				
27	Chicken, Breast	0.5-0.9	Wire rack	4
			Universal tray	1
Marinate breasts and put on the rack.				
28	Chicken Drumstick	0.5-0.9	Wire rack	4
			Universal tray	1
Brush with oil and spices and put on rack.				
29	Duck, Breast	0.3-0.7	Wire rack	4
			Universal tray	1
Put duck breasts with fat-side up on the rack. The first setting is for medium, the second for medium- well done cooking level.				
30	Trout fillet, baked	0.3-0.7	Universal tray	4
			Put trout fillets with the skin side up on the universal tray.	
31	Trout	0.3-0.7	Wire rack	4
			Universal tray	1
Rinse and clean the fish and put head to tail on the rack. Add lemon juice, salt and herbs inside fish. Cut skin surface with knife. Brush oil and salt.				

Cooking smart

Code	Food	Weight (kg)	Accessory	Level
32	Sole	0.3-0.7	Universal tray	3
		Put sole on baking paper on the universal tray. Cut surface with knife.		
33	Salmon steak/fillet	0.3-0.7	Wire rack	4
			Universal tray	1
Rinse and clean fillets or steaks. Put fillets skin side up on rack.				
34	Roast vegetables	0.3-0.7	Universal tray	4
		Rinse and prepare slices of courgette, egg plant, pepper, onion and cherry tomatoes. Brush with olive oil, herbs and spices. Distribute evenly on universal tray.		
35	Baked potato halves	0.5-0.9	Universal tray	3
		Cut large potatoes (each 200 g) into halves lengthways. Put with cut side up on universal tray and brush with olive oil, herbs and spices.		
36	Frozen Oven Chips	0.3-0.7	Universal tray	3
		Distribute frozen oven chips evenly on universal tray.		
37	Frozen potato wedges	0.3-0.7	Universal tray	3
		Distribute frozen potato wedges evenly on universal tray.		
38	Frozen Pizza	0.3-0.7	Wire rack	3
		Start programme, after preheating beep sounds, put the frozen pizza on the middle of the wire rack.		

Code	Food	Weight (kg)	Accessory	Level
39	Homemade Pizza	0.8-1.2	Universal tray	2
		Prepare homemade pizza with the yeast dough and put it on the universal tray. The weight include dough and topping such as sauce, vegetables, ham and cheese. Start programme, after preheating beep sounds, put tray into the oven.		
40	Dough Proofing	0.3-0.7	Wire rack	2
		Prepare dough in bowl, cover with cling film. Put in centre of rack.		

Dual cook

The following table presents 10 auto programmes for cooking, roasting and baking. You can use only upper zone or lower zone and use the upper and lower zone at the same time.

The programme contains its quantities, weight ranges and appropriate recommendations. Cooking modes and times have been pre-programmed for your convenience. You will find some recipes for the auto programmes in your instruction book.

All dual auto cook programmes include preheating and display the preheating progress.

Please put the food in the oven after preheating beep.

Then, press the **Dial Knob** to start Auto Cook.

WARNING

Always use oven gloves while taking out food.

1. Upper

Code	Food	Weight (kg)	Accessory	Level
1	Potato gratin	1.0-1.5	Wire rack	4
		Prepare fresh potato gratin using an ovenproof dish, 22-24 cm. Start programme, after preheating beep sounds, put dish on the centre of rack.		
2	Lasagne	1.0-1.5	Wire rack	4
		Prepare homemade lasagna using 22-24 cm ovenproof dish. Start programme, after preheating beep sounds, put dish on the centre of rack.		
3	Chicken Drumstick	0.5-0.9	Wire rack	4
			Universal tray	4
		Brush with oil and spices and put on rack.		

Code	Food	Weight (kg)	Accessory	Level
4	Baked potato halves	0.5-0.9	Universal tray	4
		Cut large potatoes (each 200 g) into halves lengthways. Put with cut side up on universal tray and brush with olive oil, herbs and spices.		
5	Frozen oven chips	0.3-0.7	Universal tray	4
		Distribute frozen oven chips evenly on universal tray.		

2. Lower

Code	Food	Weight (kg)	Accessory	Level
1	Apple pie	1.2-1.4	Wire rack	1
		Prepare apple pie using a 20-24 cm round metal baking tin. Start programme, after preheating beep sounds, put tin on the centre of rack.		
2	Apple puff pastry	0.3-0.4	Universal tray	1
		Put apple puff pastries on baking paper on universal tray. Start programme, after preheating beep sounds, put tray into the oven.		
3	Quiche Lorraine	1.2-1.5	Wire rack	1
		Prepare quiche dough, put in a round quiche dish with 22-24 cm diameter. Start programme, after preheating beep sounds add filling and put dish on the centre of rack.		

Cooking smart

Code	Food	Weight (kg)	Accessory	Level
4	Frozen Pizza	0.3-0.7	Wire rack	1
		Start programme, after preheating beep sounds, put the frozen pizza on the middle of the wire rack.		
5	Home made Pizza	0.8-1.2	Universal tray	1
		Prepare homemade pizza with the yeast dough and put it on the universal tray. The weight include dough and topping such as sauce, vegetables, ham and cheese. Start programme, after preheating beep sounds, put tray into the oven.		

3. Twin

You can select one auto programme for the lower and upper zone and cook simultaneously.

CAUTION









When you use either the upper or lower zone, the fan and the heater of the other zone may operate for optimal performance. The zone that is not being used must not be used for any unintended purposes.

Test dishes

According to standard EN 60350-1.

1. Baking

The recommendations for baking refer to a preheated oven. Do not use the Fast Preheat function. Always put trays the slanted side to the door front.

Type of food	Accessory	Level	Type of heating	Temp. (°C)	Time (min.)
Small cakes	Universal tray	3		165	23-28
		3		165	25-30
		1+3		155	33-38
Shortbread	Universal tray	1+3		140	28-33
Fatless sponge cake	Wire rack + Spring form cake tin (Dark coated, Ø 26 cm)	2		165	30-35 *
		2		160	30-35
		1+4		155	35-40
Apple pie	Wire rack + 2 Spring form cake tins ** (Dark coated, Ø 20 cm)	2, placed diagonally		160	70-80
	Universal tray + Wire rack + 2 Spring form cake tins *** (Dark coated, Ø 20 cm)	1+3		160	80-90



* Increase the cooking time by 5 minutes if you are cooking in Conventional mode using a glass ovenware (Ø 26 cm).

** Two cakes are arranged on the grid at the back left and at the front right.

*** Two cakes are arranged in the center on top of each other.



2. Grilling

Preheat the empty oven for 5 minutes using Large Grill function.

Type of food	Accessory	Level	Type of heating	Temp. (°C)	Time (min.)
White bread toast	Wire rack	5		270 (Max)	1-2
Beef burgers * (12 ea)	Wire rack + Universal tray (to catch drippings)	4 1		270 (Max)	1 st 15-18 2 nd 5-8

* Turn over after $\frac{2}{3}$ of the cooking time.

3. Roasting

Type of food	Accessory	Level	Type of heating	Temp. (°C)	Time (min.)
Whole chicken * 1.3-1.5 kg	Wire rack + Universal tray (to catch drippings)	3 1		200	60-75
Whole chicken * 1.5-1.7 kg	Wire rack + Universal tray (to catch drippings)	3 1		200	70-85

* Turn over after half of time.

Collection of frequent Auto cook recipes

Potato gratin

Ingredients 800 g potatoes, 100 ml milk, 100 ml cream, 50 g beaten whole egg, 1 tbsp each of salt, pepper, nutmeg, 150 g grated cheese, butter, thyme

Directions Peel potatoes and slice them to 3 mm thickness. Rub the butter all over the surface of a gratin dish (22-24 cm). Spread the slices on a clean towel and keep them covered with the towel while you prepare the rest of the ingredients.

Mix the rest of the ingredients except for grated cheese into a large bowl and stir well. Layer the potato slices in the dish slightly overlapping and pour the mixture over the potatoes. Spread the grated cheese over the top and bake. After cooking, serve sprinkled with a few fresh thyme leaves.

Vegetable gratin

Ingredients 800 g vegetables (courgette, tomato, onion, carrot, pepper, pre-cooked potatoes), 150 ml cream, 50 g beaten whole egg, 1 tbsp each of salt, herb (pepper, parsley or rosemary), 150 g grated cheese, 3 tbsp olive oil, some thyme leaves

Directions Wash the vegetables and slice them to 3-5 mm thickness. Layer the slices on a gratin dish (22-24 cm) and pour the oil on the vegetables. Mix the rest of the ingredients except for grated cheese and pour on the vegetables. Spread the grated cheese over the top and bake. Then serve sprinkled with a few fresh thyme leaves.

Cooking smart

Lasagne

Ingredients 2 tbsp olive oil, 500 g minced beef, 500 ml tomato sauce, 100 ml beef stock, 150 g dried lasagne sheets, 1 onion (chopped), 200 g grated cheese, 1 tsp each of dried parsley flakes, oregano, basil

Directions Prepare tomato meat sauce. Heat the oil in a frying pan, then cook the minced beef and chopped onion for about 10 min until browned all over. Pour over the tomato sauce and beef stock, add the dried herbs. Bring up to the boil, then simmer for 30 min.
Cook lasagne noodles according to package directions. Layer the lasagne noodle, meat sauce, and cheese then repeat. Then sprinkle evenly with remaining cheese on the top of layer of noodles and bake.

Apple pie

Ingredients

- **Pastry:** 275 g flour, $\frac{1}{2}$ tbsp salt, 125 g white castor sugar, 8 g vanilla sugar, 175 g cold butter, 1 egg(beaten)
- **Filling:** 750 g firm whole apples, 1 tbsp lemon juice, 40 g sugar, $\frac{1}{2}$ tbsp cinnamon, 50 g seedless raisins, 2 tbsp bread crumbs

Directions Sift the flour with the salt above a big bowl. Sift the castor sugar and vanilla sugar with it. Cut with 2 knives the butter through the flour in small cubes. Add $\frac{3}{4}$ of the beaten egg. Knead all the ingredients in the food processor until a crumbly mass appears. Form the dough into a ball with your hands. Wrap it in plastic foil and leave it chilled for about 30 min. Grease the spring tin (24-26 cm diameter) and dust the surface with flour. Roll out $\frac{3}{4}$ of the dough till 5 mm thickness. Put it in the tin (bottom and sides). Peel and core the apples. Cut them in cubes of about $\frac{3}{4} \times \frac{3}{4}$ cm. Sprinkle the apples with lemon juice and mix well. Wash and dry the currants and raisins. Add sugar, cinnamon, raisins and currants. Mix well and sprinkle the bottom of dough with bread crumbs. Press slightly. Roll out the rest of the dough. Cut the dough in small strips and put them cross wise on the filling. Brush the pie evenly with the rest of the beaten egg.

Quiche Lorraine

- Ingredients**
- **Pastry:** 200 g plain flour, 80 g butter, 1 egg
 - **Filling:** 75 g cubed fatless bacon, 125 ml cream, 125 g crème fraiche, 2 eggs, beaten, 100 g grated cheese from Switzerland, salt and pepper

Directions To make the pastry, put the flour, butter and egg in a bowl and mix to a soft pastry and then rest it in the refrigerator for 30 min. Roll out the pastry and place in the greased ceramic dish for quiche (25 cm diameter). Prick the bottom with a fork. Mix the egg, cream, crème fraiche, cheese, salt and pepper. Pour it on the pastry just before baking.

Fruit crumbles

- Ingredients**
- **Topping:** 200 g flour, 100 g butter, 100 g sugar, 2 g salt, 2 g cinnamon powder
 - **Fruit:** 600 g mixed fruits

Directions Mix all ingredients until to be crumble for making topping. Spread the mixed fruits into an oven dish and sprinkle the crumble.

Homemade pizza

- Ingredients**
- **Pizza dough:** 300 g flour, 7 g dried yeast, 1 tbsp olive oil, 200 ml warm water, 1 tbsp sugar and salt
 - **Topping:** 400 g sliced vegetable (aubergine, courgette, onion, tomato), 100 g ham or bacon(chopped), 100 g grated cheese

Directions Put the flour, yeast, oil, salt, sugar and warm water in a bowl and mix to a wet dough. Knead in a mixer or by hand about 5-10 min. Cover with lid and place in oven for 30 min at 35 °C to prove. Roll out the dough on a floured surface into a rectangle shape and put on the tray or pizza pan. Spread the tomato puree on the dough and place ham, mushroom, olive and tomato. Sprinkle evenly with cheese on the top and bake.

Roast sirloin of beef

- Ingredients** 1 kg sirloin of beef joint, 5 g salt, 1 g pepper, 3 g each of rosemary, thyme

Directions Season the beef with salt, pepper and rosemary and leave in refrigerator for 1 hour. Put on the Wire rack. Put it in the oven and cook.



Cooking smart

Herb roasted lamb chops

Ingredients 1 kg lamb chops (6 pieces), 4 large garlic cloves (pressed), 1 tbsp fresh thyme (crushed), 1 tbsp fresh rosemary (crushed), 2 tbsp salt, 2 tbsp olive oil

Directions Mix the salt, garlic, herbs and oil and add the lamb. Turn to coat and leave at a room temperature at least 30 min to 1 hour.

Rack of Pork rib

Ingredients 2 racks pork spare ribs, 1 tbsp black peppercorns, 3 bay leaves, 1 onion (chopped), 3 garlic cloves (chopped), 85 g brown sugar, 3 tbsp Worcestershire sauce, 2 tbsp Tomato puree, 2 tbsp olive oil

Directions Make a barbecue sauce. Heat oil in a sauce pan and add the onion. Cook until softened and add remaining ingredients. Broil and reduce heat and simmer for 30 min until thickened. Marinate the rib with the barbecue sauce at least 30 min to 1 hour.

Maintenance

Cleaning

For easier cleaning, regularly clean the oven.

WARNING

- Make sure the oven and accessories are cool before cleaning.
- Do not use abrasive cleaning agents, hard brushes, scouring pads or cloths, steel wool, knives or any other abrasive materials.

Oven interior

- For cleaning the interior of the oven, use a clean cloth and a mild cleaning agent or warm soapy water.
- Do not hand-clean the door seal.
- To avoid damaging the enamelled oven surfaces, only use standard oven cleaners.
- To remove stubborn soils, use a special oven cleaner.
- As the temperature of the cooking room increases at an initial period, you may find some spots on the inner glass of the door. If this is the case, turn off the oven and wait until it cools down. Then, use kitchen paper or neutral detergent with a clean cloth to wipe up the inner glass.

Oven exterior

For cleaning the exterior of the oven such as the oven door, handle, and display, use a clean cloth and a mild cleaning detergent or warm soapy water, and dry with a kitchen roll or dry towel.

Grease and dirt can remain, especially around the handle because of the hot air coming from inside. It is recommended to clean the handle after each use.

Accessories

Wash the accessories after every use, and dry it with a tea towel. To remove stubborn impurities, soak the used accessories in warm soapy water for about 30 minutes before washing.



Catalytic enamel surface (applicable models only)

The removable parts are coated with dark grey catalytic enamel. They can be soiled with oil and fat spattered by the circulating air during convection heating. However, these impurities burn off at oven temperatures of 200 °C or above.

1. Remove all accessories from the oven.
2. Clean the interior of the oven.
3. Select Convection mode with max temperature, and run the cycle for an hour.

Door

Do not remove the oven door unless for cleaning purposes. To remove the door for cleaning, follow these instructions.

⚠ WARNING

The oven door is heavy.

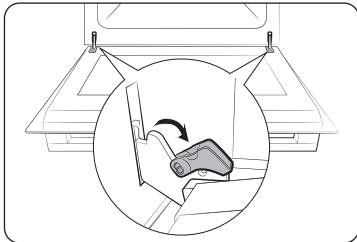

1. Open the door and flip open the clips at both hinges.

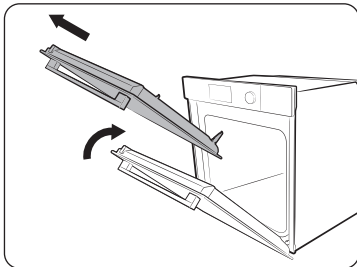

2. Close the door approximately 70°. Hold the oven door by the sides using both hands, and lift and pull upwards until the hinges are removed.
3. Clean the door with soapy water and a clean cloth.

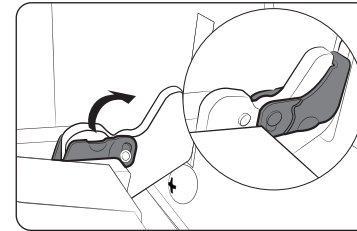

4. When done, follow steps 1 to 2 above in the reverse order to reinstall the door. Make sure the clips are hinged on both sides.

Door glass

Depending on the model, the oven door is equipped with 3-4 sheets of glass placed against each other. Do not remove the door glass unless for cleaning purposes. To remove the door glass for cleaning, follow these instructions.

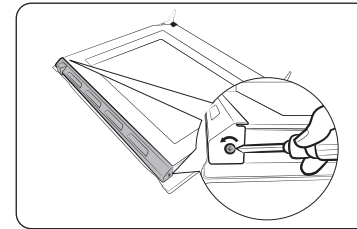

1. Use a screwdriver to remove the screws on the left and right sides.

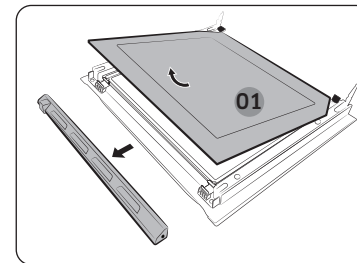

2. Detach the coverings in the arrow directions
3. Remove the first sheet from the door.

Maintenance

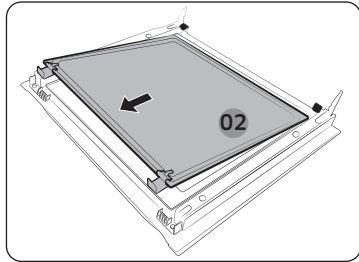

4. Remove the second sheet from the door in the arrow direction.

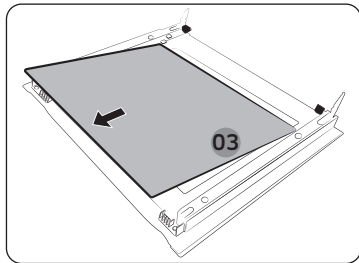

5. Remove the third sheet from the door in the arrow direction.

6. Clean the glass with soapy water and a clean cloth.

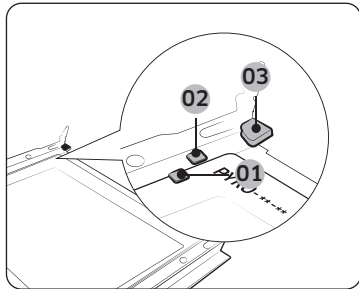

- 01 Support clip 1
- 02 Support clip 2
- 03 Support clip 3

7. When done, reinsert the sheets as follows:

- See the picture and locate the hinges. Insert sheet 3 below support clip 1, sheet 2 between support clip 1 and 2, and sheet 1 into support clip 3 in this order. Make sure the printed side of sheets is inserted inward.

⚠ CAUTION

To identify the correct side of the sheet, locate the "PYRO" mark on the corner of every sheet.
 Correct direction: PYRO-**-**
 Wrong direction: **-**-ORYP

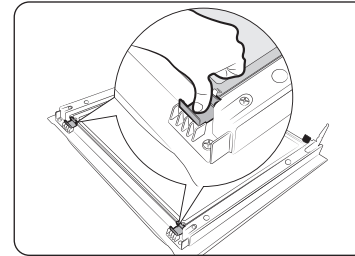

8. After inserting the sheet 2, press down the glass clips and check if they secure the glass sheet properly.
 9. Follow steps 1-2 above in the reverse order to reinstall the coverings.

⚠ WARNING

To prevent heat leaks, make sure you properly reinsert the glass sheets.

Dual door glass (applicable models only)

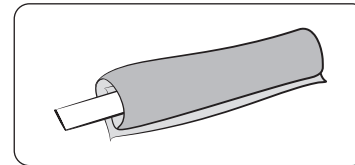

1. Tie the wet tissue to stick.

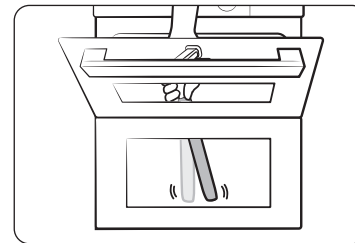

2. Put on the towel below door.
 3. Clean the door.
 4. Apply detergent to tissue and clean again.
 5. Wipe the dry tissue to the moisture and bubble.

⚠ CAUTION

Do not detach the door for cleaning.

Water collector

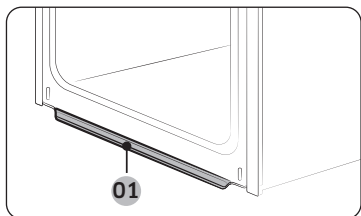

01 Water collector

The water collector collects not only excess moisture from cooking but also food residue. The water collector cannot be detached. Wipe water on the water collector when the oven cools down after a cooking process.

⚠ WARNING

If you encounter a water leak from the water collector, contact us at a local Samsung service centre.

Side runners (applicable models only)

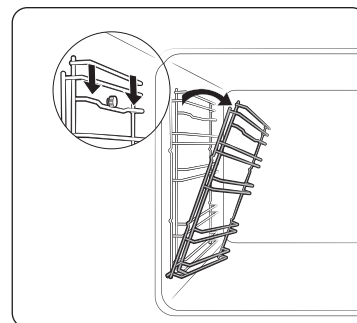

1. Press the top line of the left side runner, and lower by approximately 45°.

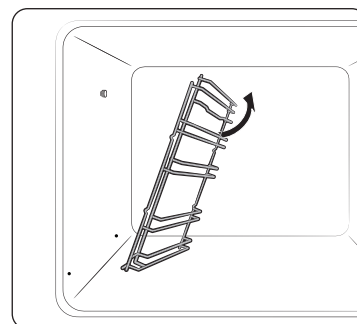

2. Pull and remove the bottom line of the left side runner.
3. Remove the right side runner in the same way.
4. Clean both side runners.
5. When done, follow steps 1 to 2 above in the reverse order to reinsert the side runners.

📖 NOTE

The oven operates without the side runners and racks in position.

Maintenance

Replacement

Bulbs

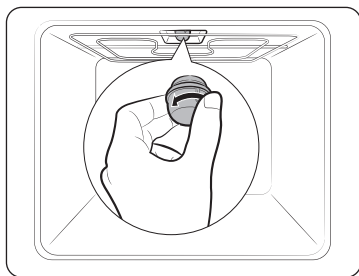

1. Remove the glass cap by turning anti-clockwise.
2. Replace the oven light.
3. Clean the glass cap.
4. When done, follow step 1 above in the reverse order to reinsert the glass cap.

⚠ WARNING

- Before replacing a bulb, turn off the oven and unplug the power cord.
- Use only 25-40 W/220-240 V, 300 °C heat-resistant bulbs. You can purchase approved bulbs at a local Samsung service centre.
- Always use a dry cloth when handling a halogen bulb. This is to prevent the bulb from being tampered with fingerprints or sweat, resulting in a shortened lifecycle.

Side oven light

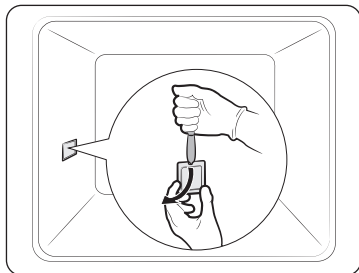

1. Hold the lower end of the cover of the side oven light with one hand, and use a flat-sharp tool such as a table knife to remove the cover as shown.
2. Replace the side oven light.
3. Reinsert the light cover.

Troubleshooting

Checkpoints

If you encounter a problem with the oven, first check the table below and try the suggestions. If the problem continues, contact a local Samsung service centre.

Problem	Cause	Action
The buttons cannot be pressed properly.	• If there is foreign matter caught between the buttons	• Remove the foreign matter and try again.
	• Touch model: if there is moisture on the exterior	• Remove the moisture and try again.
	• If the lock function is set	• Check whether the lock function is set.
The time is not displayed.	• If there is no power supplied	• Check whether there is power supplied.
The oven does not work.	• If there is no power supplied	• Check whether there is power supplied.
The oven stops while in operation.	• If it is unplugged from the power socket	• Reconnect the power.
The power turns off during operation.	• If continuous cooking takes a long time	• After cooking for a long time, let the oven cool.
	• If the cooling fan does not work	• Listen for the sound of the cooling fan.
	• If the oven is installed in a place without good ventilation	• Keep the gaps specified in the product installation guide.
	• When using several power plugs in the same socket	• Use a single plug.

Problem	Cause	Action
There is no power to the oven.	<ul style="list-style-type: none"> If there is no power supplied 	<ul style="list-style-type: none"> Check whether there is power supplied.
The oven exterior is too hot during operation.	<ul style="list-style-type: none"> If the oven is installed in a place without good ventilation 	<ul style="list-style-type: none"> Keep the gaps specified in the product installation guide.
The door cannot be opened properly.	<ul style="list-style-type: none"> If there is food residue stuck between the door and product interior 	<ul style="list-style-type: none"> Clean the oven well and then open the door again.
The interior light is dim or does not turn on.	<ul style="list-style-type: none"> If the lamp turns on and then off 	<ul style="list-style-type: none"> The lamp automatically turns off after a certain amount of time to save power. You can turn it on again by pressing the oven light button.
	<ul style="list-style-type: none"> If the lamp is covered by foreign matter during cooking 	<ul style="list-style-type: none"> Clean the inside of the oven and then check.
Electric shock occurs on the oven.	<ul style="list-style-type: none"> If the power is not properly grounded If you are using a socket without grounding 	<ul style="list-style-type: none"> Check whether the power supply is properly grounded.
There is water dripping.	<ul style="list-style-type: none"> There may be water or steam in some cases depending on the food. This is not a product malfunction. 	<ul style="list-style-type: none"> Let the oven cool and then wipe with a dry dish towel.
There is steam through a crack in the door.		
There is water remaining in the oven.		

Problem	Cause	Action
The brightness inside the oven varies.	<ul style="list-style-type: none"> The brightness changes depending on power output changes. 	<ul style="list-style-type: none"> Power output changes during cooking are not malfunctions, so there is no need to worry.
Cooking is finished, but the cooling fan is still running.	<ul style="list-style-type: none"> The fan automatically runs for a certain amount of time to ventilate inside the oven. 	<ul style="list-style-type: none"> This is not a product malfunction, so there is no need to worry.
The oven does not heat.	<ul style="list-style-type: none"> If the door is open 	<ul style="list-style-type: none"> Close the door and restart.
	<ul style="list-style-type: none"> If oven controls are not correctly set 	<ul style="list-style-type: none"> Refer to the chapter on oven operation and reset the oven.
	<ul style="list-style-type: none"> If the household fuse has been blown or the circuit breaker has been tripped. 	<ul style="list-style-type: none"> Replace the fuse or reset the circuit. If it happens repeatedly, call an electrician.
Smoke comes out during operation.	<ul style="list-style-type: none"> During initial operation 	<ul style="list-style-type: none"> Smoke may come from the heater when you first use the oven. This is not a malfunction, and if you run the oven 2-3 times, it should stop happening.
	<ul style="list-style-type: none"> If there is food on the heater 	<ul style="list-style-type: none"> Let the oven cool sufficiently and remove the food from the heater.

Troubleshooting

Problem	Cause	Action
There is a burning or plastic smell when using the oven.	<ul style="list-style-type: none"> If using plastic or other containers that are not heat-resistant 	<ul style="list-style-type: none"> Use glass containers suitable for hot temperatures.
The oven does not cook properly.	<ul style="list-style-type: none"> If the door is often opened during cooking 	<ul style="list-style-type: none"> Do not frequently open the door unless you are cooking things that need to be turned. If you frequently open the door, the interior temperature will be lower and this may affect the results of your cooking.
The oven is warm during pyro cleaning.	<ul style="list-style-type: none"> This is because pyro cleaning uses high temperatures. 	<ul style="list-style-type: none"> This is not a product malfunction, so there is no need to worry.
There is a burning smell during pyro cleaning.	<ul style="list-style-type: none"> Pyro cleaning uses high temperatures, so you may smell food residue burning. 	<ul style="list-style-type: none"> This is not a product malfunction, so there is no need to worry.
Steam cleaning does not work.	<ul style="list-style-type: none"> This is because the temperature is too high. 	<ul style="list-style-type: none"> Let the oven cool and then use.
Dual cook mode does not work.	<ul style="list-style-type: none"> If the divider is not properly assembled 	<ul style="list-style-type: none"> Insert the divider correctly and use.
Single cook mode does not work.	<ul style="list-style-type: none"> If the divider is inserted in the oven. 	<ul style="list-style-type: none"> Take out the divider and use.

Information codes

If the oven fails to operate, you may see an information code on the display. Check the table below and try the suggestions.

Code	Meaning	Action
C-d1	Door lock malfunctions	Turn off the oven and then restart. If the problem continues, turn off all power for 30 seconds or more and then reconnect. If the problem is not fixed, please contact a service centre.
C-20	Sensor malfunctions	
C-21		
C-22		
C-23		
C-F1	Only occurs during EEPROM Read/Write	
C-70	Steam-related problems	
C-72		
C-F0	If there is no communication between the main PCB and sub PCB	
C-F2	Occurs when a communication problem is maintained between the Touch IC <-> Main or Sub micom	
C-d0	Button problem Occurs when a button is pressed and held for a period of time.	Clean the buttons and make sure there is no water on/around them. Turn off the oven and try again. If the problem continues, contact a local Samsung service centre.

Code	Meaning	Action
-dC-	If the divider is removed during cooking in Dual cook mode. If the divider is inserted during cooking in Single cook mode.	The divider must not be removed during cooking in Dual cook mode. Turn off the oven and then restart. If the problem continues, turn off all power for 30 seconds or more and then reconnect. If the problem is not fixed, please contact a service centre.
S-01	Safety shutoff Oven has continued operating at a set temperature for an extended time. <ul style="list-style-type: none"> • Under 100 °C - 16 hours • From 105 °C to 240 °C - 8 hours • From 245 °C to Max - 4 hours 	This is not system failure. Turn off the oven and remove food. Then try again normally.

Technical specifications

SAMSUNG strives to improve its products at all times. Both the design specifications and these user instructions are thus subject to change without notice.

Connection voltage		230-240 V ~ 50 Hz
Maximum connected load power		3650-3950 W
Dimensions (W x H x D)	Main unit	595 x 596 x 570 mm
	Built-in	560 x 579 x 549 mm
Volume		76 liter

* This product contains a light source of energy efficiency class <G>.

Appendix

Product data sheet

SAMSUNG	SAMSUNG		
Model identification	NV7B564****, NV7B565****, NV7B566****, NV7B567****, NV7B568****, NV7B564**C*, NV7B566**C*, NV7B568**C*, NV7B574****, NV7B575****, NV7B576****, NV7B577****, NV7B578****		
Energy Efficiency Index per cavity (EEI _{cavity})	81.6		
Energy Efficiency Class per cavity	A+		
Energy consumption (electricity) required to heat a standardised load in a cavity of an electric heated oven during a cycle in conventional mode per cavity (electric final energy) (EC _{electric cavity})	1.05 kWh/cycle		
Energy consumption required to heat a standardised load in a cavity of an electric heated oven during a cycle in fan-forced mode per cavity (electric final energy) (EC _{electric cavity})	0.71 kWh/cycle		
Number of cavities	1		
Heat source per cavity (electricity or gas)	electricity		
Volume per cavity (V)	76 L		
Type of oven	Built-in		
Mass of the appliance (M)	NV7B564**** : 33.4kg NV7B565**** : 38.4kg NV7B566**** : 35.6kg NV7B567**** : 40.6kg NV7B568**** : 35.6kg	NV7B564**C* : 35.4kg NV7B566**C* : 37.6kg NV7B568**C* : 37.6kg	NV7B574**** : 36.9kg NV7B575**** : 40.9kg NV7B576**** : 39.1kg NV7B577**** : 43.1kg NV7B578**** : 39.1kg

Data determined according to standard EN 60350-1, EN 50564, Commission Regulations (EU) No 65/2014 and (EU) No 66/2014, and Regulation (EC) NO 1275/2008.

60 English

Overall Standby Power consumption (W) (All network ports is "on" condition)		1.9 W
Period of time for the power management (min)		20 min.
WIFI	Standby-mode Power Consumption (W)	1.9 W
	Period of time for the power management (min.)	20 min.
Off Mode	Power consumption	0.5 W
	Period of time for the power management (min.)	30 min.

Energy saving tips

- During cooking, the oven door should remain closed except for turning food over. Do not open the door frequently during cooking to maintain the oven temperature and to save energy.
- Plan oven use to avoid turning the oven off between cooking one item and the next to save energy and reduce the time for re-heating the oven.
- If cooking time is more than 30 minutes, the oven may be switched off 5-10 minutes before the end of the cooking time to save energy. The residual heat will complete the cooking process.
- Wherever possible cook more than one item at a time.

NOTE

Hereby, Samsung declares that this radio equipment is in compliance with Directive 2014/53/EU and with the relevant statutory requirements in the UK. The full text of the EU declaration of conformity and the UK declaration of conformity is available at the following internet address: The official Declaration of conformity may be found at <http://www.samsung.com>. go to Support > Search Product Support and enter the model name.

	Frequency range	Transmitter power (Max)
Wi-Fi	2412-2472 MHz	20 dBm
Bluetooth	2402-2480 MHz	10 dBm

Open Source Announcement

The software included in this product contains open source software.
The following URL http://opensource.samsung.com/opensource/SMART_TP1_0/seq/0 leads to open source license information as related to this product.



QUESTIONS OR COMMENTS?

COUNTRY	CALL	OR VISIT US ONLINE AT
AUSTRIA	0800 72 67 864 (0800-SAMSUNG)	www.samsung.com/at/support
BELGIUM	02-201-24-18	www.samsung.com/be/support (Dutch) www.samsung.com/be_fr/support (French)
DENMARK	707 019 70	www.samsung.com/dk/support
FINLAND	030-6227 515	www.samsung.com/fi/support
FRANCE	01 48 63 00 00	www.samsung.com/fr/support
GERMANY	06196 77 555 77	www.samsung.com/de/support
ITALIA	800-SAMSUNG (800.7267864)	www.samsung.com/it/support
CYPRUS	8009 4000 only from landline, toll free	www.samsung.com/gr/support
GREECE	80111-SAMSUNG (80111 726 7864) only from land line (+30) 210 6897691 from mobile and land line	www.samsung.com/gr/support
LUXEMBURG	261 03 710	www.samsung.com/be_fr/support
NETHERLANDS	088 90 90 100	www.samsung.com/nl/support
NORWAY	21629099	www.samsung.com/no/support
PORTUGAL	210 608 098 Chamada para a rede fixa nacional Dias úteis das 9h às 20h	www.samsung.com/pt/support
SPAIN	91 175 00 15	www.samsung.com/es/support
SWEDEN	0771-400 300	www.samsung.com/se/support
SWITZERLAND	0800 726 786	www.samsung.com/ch/support (German) www.samsung.com/ch_fr/support (French)
UK	0333 000 0333	www.samsung.com/uk/support
IRELAND (EIRE)	0818 717100	www.samsung.com/ie/support



DG68-01412D-00