

Built in Double Oven

LAM4603



Instructions & Installation

LAMONA
Exclusive to Howdens Joinery Co.

Register 
my appliance www.howdens.com/appliance-registration

Register my appliance

Register your Lamona appliance purchased from Howdens Joinery to allow us to easily contact you in the event of important product updates at:

www.howdens.com/appliance-registration

LAMONA

Exclusive to Howdens Joinery Co.

See back page for product serial number

Dear Customer,
Congratulations on your choice of oven.

The user manual will help you use your product quickly and safely.

- Please read this user manual before installing and using the oven.
- Always follow the safety instructions.
- Keep this user manual within easy reach for future reference.
- Please read any other documents supplied with the product.

Explanation of symbols

Throughout this user manual the following symbols are used:



Important information or useful tips about usage.



Warning for possible hazards to health and property.



Warning possibility of electric shock.

Product information correct at the time of publication in January 2017.

The company has a policy of continuous product development and reserves the right to change any products and specifications given in this manual.



The appliance is marked according to the European Directive 2012/19/EU on waste Electrical and Electronic Equipment (WEEE). By ensuring this product is disposed of correctly you will help prevent potential negative consequences for the environment and human health. The symbol on this product indicates that this product may not be treated as household waste. Instead it should be handed over to the applicable collection point for recycling of electronic equipment. Disposal must be carried out in accordance with local environmental regulations for waste disposal. For more detailed information please contact your local council household waste site.

Index

01 - Before using the oven	05	09 - How to operate the timer	16
		Minute minder	16
02 - Safety	05	Timer setting	16
General	05	Time stop point	16
Safety for children	05	Delayed start cooking	17
Safety when working with electricity	08		
Safety and cleaning	08	10 Cooking and baking advice	18
Shelf positions	09		
		11 Cooking tables	19
03 - General information	10		
Oven layout	10	12 Care and maintenance	21
		General information	21
04 - Preparation	11	Cleaning the control panel	21
First cleaning of the appliance	11	Cleaning the door	21
Setting the time	11	Removal of the oven door	21
Initial heating	11	Removing the inner door glass	22
Tips for saving energy	11	Replacing the oven Lamp	22
05 Operation modes	12	13 Installation	23
Operating modes	12	Before installation	23
06 How to operate the main oven	13	14 Electrical connections	24
How to use the main oven	13	Cooling Fan	25
Select a temperature and operating mode	13		
Switch off the oven	13	15 Technical specification	26
07 How to operate the top oven	14	16 Troubleshooting	27
How to use the top oven	14		
Select a temperature and operating mode	14	17 Your Guarantee	28
Shelf positions	14		
Switch off the oven	14		
08 - How to operate the Grill	15		
How to use the grill	15		
Select grill temperature and operating mode	15		
Shelf positions	15		
Switch off the grill	15		

01 - Before using the Oven

- Make sure that you have removed all packaging, wrappings, stickers and films from the oven's surface.
- It is recommended that you clean and wash the oven's surface before using for the first time.

02 - Safety

-  This appliance is for domestic cooking purposes only. It must not be used for other purposes, e.g room heating, or drying towels and dish cloths over the handle. Commercial use will void the guarantee (see guarantee page).
- The manufacturer shall not be liable for any damage caused by improper use or handling errors.

General

- This product is not intended to be used by persons with physical, sensory or mental disorders or unlearned or inexperienced people (including children) unless they are supervised by a person who will be responsible for their safety or who will instruct them accordingly in the use of the product.

Safety for children

- Children must be supervised to prevent them from playing with the product.
- Electrical products can be dangerous to children. Keep children away from the product when it is operating and do not allow them to play with or near the product.
-  **CAUTION:** Accessible parts of the oven may become hot when the oven or grill is in use. Children should be kept away until the product has cooled down.”
- Do not store any items above the appliance that children may reach for.
- When the door is open, do not load any heavy object on it and do not allow children to sit on it. The door or door hinges may be damaged.
- The packaging materials will be dangerous for children. Keep the packaging materials away from children. Please dispose of all parts of the packaging according to environmental

- Accessible parts may become hot during use. To avoid burns, children less than 8 years of age should be kept away unless continuously supervised.
- This appliance can be used by children aged 8 years and above, persons with reduced physical, sensory or mental capabilities or lack of experience and knowledge, if they have been given supervision or instruction concerning use of the appliance in a safe way and understand the hazards involved.
- Cleaning and user maintenance must not be made by children without supervision.
- Connect the product to an earthed outlet protected by a fuse of suitable capacity as stated in the “Technical specifications” table. Our company shall not be liable for any problems arising due to the product not being earthed in accordance with the local regulations.
- Do not operate the product if the power cable is damaged. Replace with a suitable cable by a qualified person.
- Do not operate the product if it is defective or has any visible damage.
- Do not carry out any repairs or modifications to the product.
- Never wash down the product with excessive water, as there is the risk of electric shock!
- Never use the product when your judgment or coordination is impaired by the use of alcohol and/or drugs.
- Product must be disconnected from the mains during installation, maintenance, cleaning and repair procedures.
- Repair procedures must always be performed by qualified persons. The manufacturer shall not be held responsible for damages arising from procedures carried out by unauthorised persons, which may also void the guarantee.
- Be careful when using alcoholic drinks in your dishes. Alcohol evaporates at high temperatures and may ignite when it comes into contact with hot surfaces.
- Do not heat closed tins and glass jars in the oven. The pressure that would build-up in the tin/jar may cause it to burst.





- Do not place any materials close to the product as the sides may become hot during use.
- **⚠ WARNING FIRE RISK**
- Do not place aluminium foil, baking trays or cook on the base of this oven, doing so will cause permanent damage to your appliance and cabinetry with the potential risk of fire.
- Parts of the oven may become hot during or immediately after use. Care should be taken to avoid touching the heating elements, and components inside the oven which maybe hot. Always allow oven to cool.
- If the door seal is very dirty this can prevent the door from closing properly during use, resulting in possible damage to adjacent furniture and poor efficiency. Always ensure the door seal is clean.
- Product may become hot when it is in use. Please be careful not to touch these hot surfaces.
- Always use heat resistant oven gloves when putting dishes in or removing dishes from the hot oven.
- Do not use the product if any door glass is removed or damaged.
- Always use heat resistant oven gloves when putting dishes in or removing dishes from the hot oven.
- Rear surface of the oven may get hot when it is in use. Make sure that the electrical connections do not contact the rear surface; otherwise, connections may be damaged.
- Do not trap the mains cable and do not route it over hot surfaces. The cable insulation may melt and cause a short circuit.
- Product must be installed by a qualified person in accordance with the regulations in force. Otherwise, the guarantee may become void.
- When hot and cold air meet, condensation can form. The outer door is air cooled and the inner glass will become hot during cooking, therefore some condensation might form. This is perfectly normal. All condensation will disappear as the oven reaches cooking temperature.
- Make sure that the product control knobs are switched off after every use.

Safety when working with electricity

- Any work on electrical equipment and systems should only be carried out by authorised or qualified persons.
- In case of any damage, switch off the product and disconnect it from the mains. To do this, turn off at the fuse box.
- The appliance must be installed so that it can be completely disconnected from the mains easily after installation by the isolation switch.
- Do not bend or trap cable against hot surfaces during install.
- Make sure that fuse rating is compatible with the product.
- Do not switch the oven off at the mains isolation switch immediately after cooking. Cooling fan continues to run for up to 20-30 minutes (approx) even after the oven control is turned off.
- Keep all ventilation slots clear of obstructions, as this may cause premature failure of the oven element.
- Do not allow the oven to cool with the door open. Even if the appliances door is only open a little, front panels become damaged over time.

of adjacent units could become damaged over time.

Safety and cleaning

-  Do not use harsh abrasive cleaners or sharp metal scrapers to clean the oven door since they can scratch the surface, which may result in the shattering of the glass.
-  **WARNING:** Ensure that the appliance is switched off before replacing the lamp to avoid the possibility of an electric shock.
-  Do not use oven light for household room illumination.
-  Do not use steam cleaners for cleaning.
- The appliance must not be installed behind a decorative door.

- The oven has 5 shelf positions. It is important to position the wire shelf into the runners correctly before placing items on the shelf. Do not insert shelves forcefully.

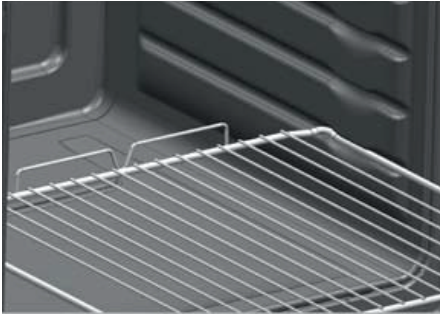

03 - General Information

Oven layout

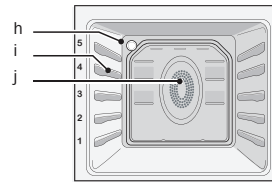
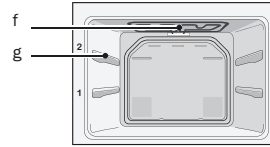
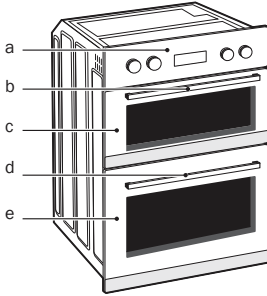

- a. Control panel
- b. Handle
- c. Top oven
- d. Handle
- e. Main Oven

- f. Grill heating element
- g. Shelf supports
- h. Light
- i. Shelf supports
- j. Fan motor (behind steel plate)

Control panel layout

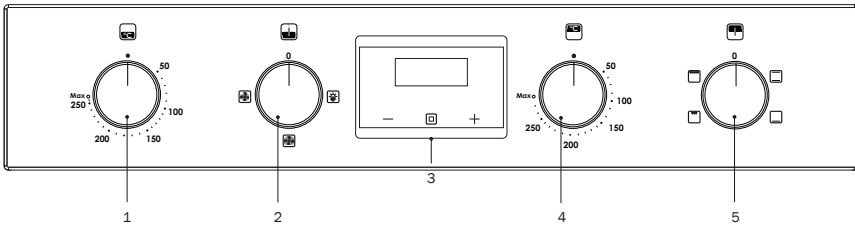

- 1 Main oven thermostat knob
- 2 Main oven function knob
- 3 Digital timer

- 4 Top oven / grill thermostat knob
- 5 Top oven/ grill function knob

Accessories



Oven tray / grill pan x1



Grill pan wire rack / trivet x1

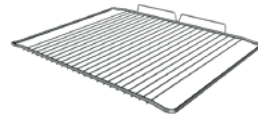

Oven shelf x3

04 - Preparation

First cleaning of the appliance

1. Remove all packaging materials.
2. Wipe the surfaces of the appliance with a damp cloth or sponge with mild detergent and dry with a clean cloth

The surface may get damaged by some detergents or cleaning materials.

Do not use aggressive detergents, cleaning powder/cream or any sharp objects.



Setting the time

Warning: The main oven will not operate until the clock is set.

When first switched on the clock will flash '12.00' Touch the + or - buttons whilst the display is flashing to adjust the time (the display stops flashing after 5 seconds and the time is displayed).



To adjust the clock:

Press mode button  x 4 times until clock symbol  is displayed. Touch the + or - whilst display is flashing to set the time of day. (The display stops flashing after 5 seconds and the time is displayed).

Initial heating

It is recommended to heat up the product for about 30 minutes and then switch it off. Thus, any production residues or layers will be burnt off and removed.

1. Take the tray and the wire grid out of the oven.
2. Close the oven doors.
3. Select Fan and Grill cooking
4. Select the highest oven & grill power levels; See How to use the electric oven, pages 8-11.
5. Operate oven & grill for about 30 minutes.
6. Turn off your oven & grill and allow to cool.

 Small amounts of smoke & fumes may emit during the initial heating process; this is normal, however monitor the oven at all times and ensure that the room is well ventilated.

Tips for saving energy

The following information will help you to use your appliance in an ecological way, and to save energy:

- Use dark coloured or enamel coated cookware in the oven as the heat transmission will be better.
- Perform a preheating operation if it is advised in the user manual or cooking instructions.
- Do not open the door of the oven frequently during cooking.
- Try to cook more than one dish in the oven at the same time whenever possible. You can place two cooking vessels onto the wire shelf.
- Cook one dish after another. The oven will already be hot.
- You can save energy by switching off your oven a few minutes before the end of the cooking time. Do not open the oven door.
- Defrost frozen dishes before cooking them if possible.

05 - Operating modes

Operating modes

All functions for the ovens and grill are listed in this section.

The order of operating modes shown here might deviate from the arrangement on your appliance.

Oven lamp



The oven is not heated. Only the oven lamp is lit, the outside cooling fan can also be running to protect cabinets from heat.

Top and bottom heat



Top and bottom heat is used. The foodstuffs are heated simultaneously from above and below. Suitable for cakes, cookies and casseroles. For best results Cook with one tray only.

Bottom heat



Only bottom heat is used. Is particularly suitable for dishes, such as pizza, which are required to be baked from bottom.

Defrost



The oven is not heated. Only the fan (in the rear wall) is in operation. Frozen granular food can be thawed slowly at room temperature, and cooked food can be cooled down.

Fan Cooking



The element & fan (in the rear wall) are both in operation. Hot air is distributed evenly and quickly all over the cavity by the fan. In most cases, preheating is not required. This mode is suitable when several levels are used for the cooking and an even temperature is required throughout the oven cavity .

Grill-small



The inner grill element in the top oven is in operation. This is suitable for small or medium-sized portions

Ensure correct shelf position is used, set the temperature to maximum level, and turn the food as required to ensure even cooking.

Grill -Full



The full grill element in the top oven is in operation. This is suitable for grilling larger dishes

Ensure correct shelf position is used, set the temperature to maximum level, and turn the food as required to ensure even cooking.

06 - How to operate the main oven

How to use the main oven

As your appliance has two ovens please ensure that the appropriate function and thermostat control are selected for the oven you wish to use.



- Main oven

Select temperature & operating mode

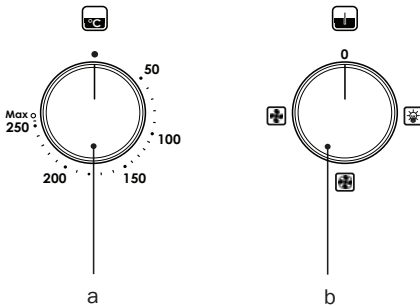

- Main oven thermostat knob
- Main oven function knob

The operating modes of the electric oven are selected with the function knob. The temperature is adjusted with the thermostat knob.

- Set thermostat knob to the desired temperature.
- Set function knob to the required operating mode.

The oven heats up to the adjusted temperature and maintains it. During heating, the temperature indicator light will remain on until the desired temperature is reached.

Shelf positions

The main oven has 5 shelf positions as illustrated below

It is important to position the wire shelf into the runners correctly.

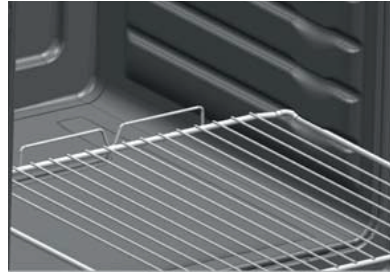

Warning Please ensure shelves are fully inserted before closing the oven door, failure to do so could lead to damage to the door.

Warning -Do not place aluminium foil or baking trays on the base of the oven. This can lead to permanent damage to your appliance.

Warning -Do not place plates, dishes or trays on the floor of the top oven cavity when main oven is in use.

Warning - Do not use the oven or grill cavity for storage when not in use.

Switch off electric oven

Turn function knob and thermostat knob to off position (top).

07 - How to operate the top oven

How to use the Top oven

As your appliance has two ovens please ensure that the appropriate function and thermostat control are selected for the oven you wish to use.



- Top oven / Grill

Select temperature & operating mode

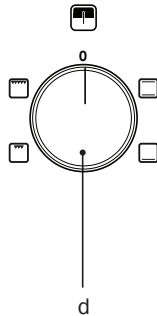
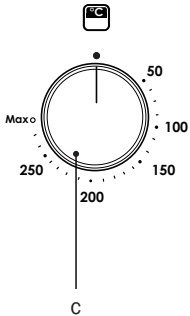

- c. Top oven thermostat knob
 - d. Top oven function knob
1. Set thermostat knob to the desired temperature.
 2. Set function knob to the required operating mode.

The oven heats up to the adjusted temperature and maintains it. During heating, the temperature indicator light will remain on until the desired temperature is reached.

Shelf positions

The top oven has 2 shelf positions.

It is important to position the wire shelf into the runners correctly.

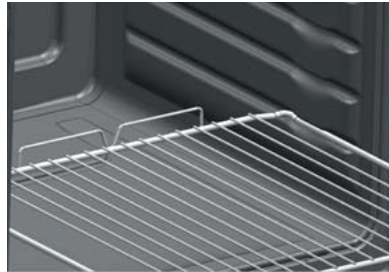

Please ensure shelves are fully inserted before closing the oven door, failure to do so could lead to damage to the door.

Warning -Do not place aluminium foil or baking trays on the base of the oven. This can lead to permanent damage to your appliance.

Warning -Do not place plates, dishes or trays on the floor of the top oven cavity when main oven is in use.

Warning - Do not use the oven or grill cavity for storage when not in use.

Switch off electric oven

Turn function knob and thermostat knob to off position (top).

08 - How to operate the Grill

How to use the grill

As your appliance is fitted with a grill please ensure that the appropriate function and thermostat control are selected for the oven you wish to use.



Select grill temperature & operating mode

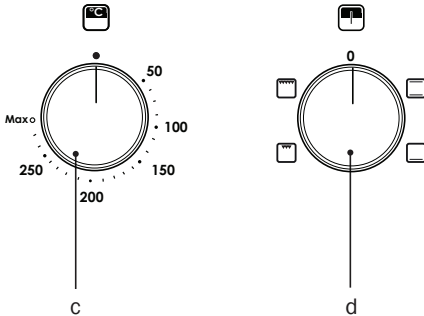

- c. Top oven / grill thermostat knob
- d. Top oven / grill function knob

1. Set thermostat knob to the desired temperature.
2. Set function knob to the required operating mode.
3. **Ensure the door is closed.**

The grill heats up to the adjusted temperature and maintains it. During heating, the temperature indicator light will remain on until the desired temperature is reached.



Shelf positions



It is important to position the wire shelf into the runners correctly.

Please ensure shelves are fully inserted before closing the oven door, failure to do so could lead to damage to the door.

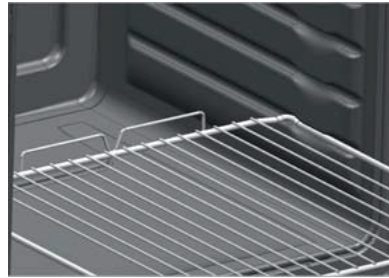

Food can be grilled using the supplied grill pan (with or without the trivet) or in a dish placed on the base of the grill cavity, according to the size and depth of the dish (using level 1).

Turn large and medium sized portions of food during the grilling process to ensure thorough and even cooking.

Warning - Never leave grill unattended when cooking food.

Warning - Only use food for grilling, which is suitable for intensive grilling heat. Do not place the food too high or too far back in the grill. This is the hottest area and food may smoke, burn or even catch fire.

Warning - Do not use aluminium foil to line the base of the grill pan.

Warning - Do not use the oven or grill cavity for storage when not in use.



Switch off grill

Turn function knob and thermostat knob to off position (top).

09 - How to operate the Timer

Minute minder (0.01 min - 2.30hr)



Press mode button  x3 times until alarm symbol  is displayed. Touch the + or - buttons to set the desired time duration. The alarm will sound when the selected time has elapsed. Touch any button to stop the alarm.

To cancel:

Press the mode button  x3 times until the alarm symbol  is displayed. Touch the + or - buttons to set the duration to 00.00.

Timer cooking

Timed operation period

Oven cooks for a selected time period then stops: (0.01 min to 10.00 hr)

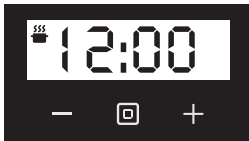

Press mode button  x1 until cook symbol  is displayed flashing.

Touch the + or - buttons to set the desired cooking time duration (display reverts to time of day after desired time period is set and the  symbol remains lit).

Select desired oven cooking mode and temperature using the oven control knobs.

The alarm will sound and the cook symbol  will flash when the selected cooking time has elapsed.

Turn oven control knobs to 'off' and touch any button to stop the alarm and return oven to 'manual' use mode.

To check time left:

Press mode button  x1

To cancel:

Press mode button  x1 time until the cook symbol  is displayed.

Touch the + or - buttons until the alarm sounds and display shows 00.00. Clock time returns.

Note: Whilst cook symbol  is flashing the oven cannot be used in 'manual' mode.

Time stop point

Oven cooks until a designated time then stops: (up to 23.59 hr)



Press mode button  x2 times until symbol **A** is displayed and flashing.

Touch the + or - buttons to set the desired stop time. (Display reverts to time of day after desired stop time is set and **A** symbol remains lit).

Select desired oven cooking mode and temperature using the oven control knobs.

The alarm will sound and the **A** symbol will flash when the selected time has been reached.

Turn oven control knobs to 'off' and touch any button to stop the alarm and turn to 'manual' use mode. (Timer will sound for 2 minutes then stop if no button is pressed).

To cancel:

Press the mode button  x2 times until the **A** symbol is displayed.

Touch the + or - button until **A** flashes, alarm will sound and time of day returns.

(Timer sounds for 2 minutes then stops if no button is pressed)

Delayed start cooking

The timed cooking modes can be combined to create a delayed start cooking period.

Programme a timed operation period

(as described on page 16)

Programme a time stop point

(as described on page 16)





Both symbols **A** and  will be displayed and the cooking process will start at a future point in time e.g -

If time stop is set to 16.00 and timed operation period is set to 1.30 hrs



- The oven will switch on at 14.30 and cook until 16.00

To check settings:

Push mode button  x1 time to see  cooking period.

Push mode  x2 times to see **A** cooking end time.

To cancel:

Press mode button  x1 time until cook symbol  is displayed.

Touch the + or - buttons until alarm sounds and display shows 00.00 clock time returns.

10 - Cooking and baking advice



Risk of scalding by hot steam! Take care when opening the oven door as steam may escape.

Tips for baking

- Use nonstick coated appropriate metal trays and containers or heat-resistant silicone moulds.
- Make best use of the space on the shelf.
- It is recommended to place the vessels in the middle of the shelf.
- Select the correct shelf position before turning the oven or grill on - don't move oven shelves when hot.
- Keep the oven door closed.

Tips for roasting

- Seasoning with lemon juice and black pepper will improve the cooking performance when cooking a whole chicken, turkey or a large piece of meat.
- Meat with bones takes about 15 to 30 minutes longer to cook than a roast of the same size without bones.
- Let meat rest in the oven for about 10 minutes after the cooking time. The juices will be better distributed throughout the meat and will not run out when the meat is cut.
- Fish in a heat proof dish should be placed at the medium or lower level.

Tips for grilling

- Grilling is ideal for cooking meat, fish and poultry and will achieve nice browning without drying out the food. Flat pieces, meat skewers and sausages are particularly suited for grilling, as are vegetables with a high water content, such as tomatoes and onions.
- Distribute the pieces to be grilled on the wire rack.
- Use tray or grill pan under the wire rack in order to collect dripping fat or juices.
- Adding some water to the grill pan will assist with cleaning.

Tips for baking cake

- If the cake is too dry, increase the temperature by 10 °C and decrease the cooking time.
- If the cake is wet, use less liquid or lower the temperature by 10 °C.
- If the cake is too dark on top, place it on a lower shelf, lower the temperature and increase the cooking time.
- If cooked well on the inside but sticky on the outside use less liquid, lower the temperature and increase the cooking time.

Tips for baking pastry

- If the pastry is too dry, increase the temperature by 10 °C and decrease the cooking time. Dampen the layers of pastry with a wash composed of milk, oil, egg.
- If the pastry takes too long to bake, pay attention that the thickness of the pastry you have prepared
- If the upper side of the pastry gets browned, but the lower part is not cooked, make sure that the amount of wash you have used for the pastry is not too much at the bottom of the pastry. Try to spread the wash equally over the pastry for an even browning.
- Cook the pastry in accordance with the mode and temperature given in the cooking table. If the bottom part is still not browned enough, place it on one lower shelf next time.

Tips for cooking vegetables

- If the vegetable dish runs out of juice and gets too dry, cook it in a dish with a lid instead of an open tray. Closed vessels will preserve the juice of the dish.
- If a vegetable dish is not cooked, boil the vegetables beforehand.

11 - Cooking Tables



The values indicated in the tables below are indicative. They may vary according to the type of food as well as your preferences of cooking.



















Baking and roasting
Level 1 is the bottom level in the oven.

MAIN OVEN COOKING TABLE				
Dish	Shelf Level	Oven Function	Temperature °C	Cooking Time min
Baking				
Cakes in tray*	level 3		175	30 - 40
	2 = level 1 & 5		175	45 - 50
Cakes in mould*	level 2		175	50 - 60
Cakes in bun cases	level 3		175	25 - 35
	2 = level 1 & 5		175	35 - 45
	3 = level 1,3 & 5		180	45 - 55
Sponge cake*	level 3		200	15 - 20
Cookies*	level 3		175	25 - 30
	2 = level 1 & 5		170 ... 190	35 - 45
	3 = level 1,3 & 5		175	30 - 40
Dough pastry*	level 3		200	35 - 45
	2 = level 1 & 5		200	50 - 60
	3 = level 1,3 & 5		200	55 - 65
Rich pastry*	level 3		200	25 - 35
	2 = level 1 & 5		200	35 - 45
	3 = level 1,3 & 5		190	45 - 55
Meat				
Lasagne*	level 3		200	30 - 40
Roast Beef	level 3		25 min at 250/max then 180 ... 190	100 - 120
Leg of Lamb	level 3		25 min at 220 then 180 ... 190	70 - 90
Roasted chicken	level 2		25 min at 250/max then 180 ... 190	55 - 65
Turkey (5.5kg)	level 1		15 min at 250/max then 190	150 - 210
Fish				
Fish	level 3		200	20 - 30

When cooking with 2 trays at the same time, place the deeper tray on the upper rack and the other one on the lower rack.
* It is suggested to perform preheating for all foods

If cooking requires preheating, heat the oven until the thermostat lamp goes out.

TOP OVEN COOKING TABLE				
Food	Shelf Level	Oven Function	Temperature °C	Cooking Time min
Cakes in tray	level 2		175	25 - 30
Cakes in mould	level 1		175	25 - 30
Cakes in bun cases	level 1		175	25 - 30
Cookies	level 2		175	25 - 30
Dough pastry	level 2		200	35 - 40
Filled Savoury pastry	level 1		180	25 - 35
Lasagne	level 1		180	30 - 40
Pizza	level 1		200	15 - 20
Roast Beef	level 2		25 min at 250/max then 180 ... 190	100 - 120
Leg of Lamb	level 2		25 min at 220 then 180 ... 190	70 - 90
Roasted chicken	level 1		15 min at 250 then 190	55 - 65
Turkey (5.5kg)	level 1		25 min at 250 then 190	150 - 210
Fish	level 2		200	20 - 30

GRILL COOKING TABLE			
Food	Shelf Level	Oven Function	Cooking Time (min)
Fish	level 1 - 2		20 - 25
Sliced chicken	level 1 - 2		25 - 30
Lamb chops	level 1 - 2		20 - 25
Steak	level 1 - 2		25 - 30
Toast	level 1 - 2		1 - 2

Please Note: cooking times may vary depending on their thickness of food

12 - Care and maintenance

General information

Service life of the product will extend and the possibility of problems will decrease if the product is cleaned at regular intervals.



Risk of electric shock!

Switch off the electricity before cleaning appliance to avoid possibility of an electric shock.



Hot surfaces may cause burns!

Allow the appliance to cool down before you clean it.

- Clean the product thoroughly after each use. This way it will be possible to remove cooking residues more easily and will avoid burning them on the next time the appliance is used.
- No special cleaning agents are required for cleaning the product. Use warm water with washing liquid, a soft cloth or sponge to clean the product and wipe with a dry cloth.
- Always ensure any excess liquid is thoroughly wiped off after cleaning and any spillage is immediately wiped dry.
- Do not use cleaning agents that contain acid or chloride to clean the stainless steel surfaces and the handle. Use a soft cloth with a liquid detergent (not abrasive) to wipe those parts clean, paying attention to sweep in a horizontal direction.



The surface may be damaged by some detergents or cleaning materials.

Do not use aggressive detergents, cleaning powder/cream or any sharp objects.

Do not use steam cleaners for cleaning.

Cleaning the control panel

Clean the control panel and control knobs with a damp cloth and wipe them dry.



Do not remove the control knobs for control panel cleaning.

Cleaning oven door

Don't use any harsh abrasive cleaners or sharp metal scrapers for cleaning the oven door. They could scratch the surface and damage the glass.

Removal of the oven door

1. Open the door.
2. Unlock the clips at the hinge housing on the right and left hand sides of the door by pressing them down as illustrated in the diagram.

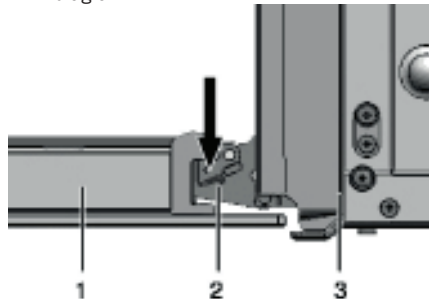

1. Door door
2. Hinge
3. Oven

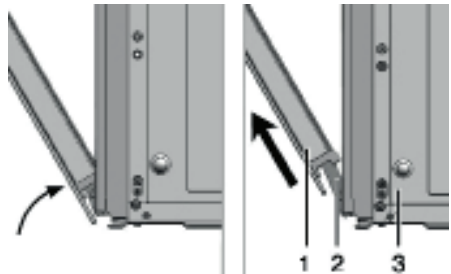

4. Raise the door to the half-way position.
5. Remove the door by pulling it up-wards to slide it from the hinges.

Steps carried out during removing process should be performed in reverse order to reattach the door.



Do not forget to lock the clips at the hinge housing when reinstalling the door.

Removing oven door inner glass

The inner glass panels of the door can be removed for cleaning.

When cleaning, avoid the use of any harsh abrasive chemicals or sharp metal scrapers as this could scratch the surface and damage the glass.

Please be aware when removing and cleaning the glass that the door has the potential to spring closed.

We recommend you support the door at all times or remove the entire door assembly prior to attempting to clean it.

In order to do this:

1. Open the door fully.

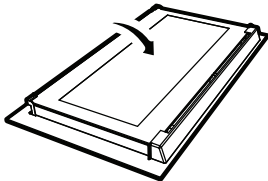

2. The top plastic cap can be pulled away from the retaining clips.

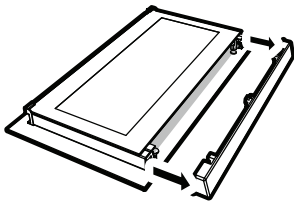

3. The upper glass can be slid out of its retaining slots and the inner glass can be removed.

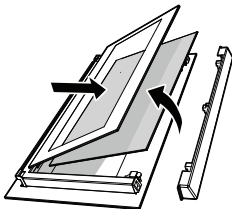

4. To replace the glass follow this process in reverse ensuring the printed surface of the glass is facing downwards.

Ensure the glass is fully located in the lower retaining slots before attempting to re-fit the top cap.

Replacing the oven lamp

! Hot surfaces may cause burns!

Make sure that the appliance is switched off and cooled down in order to avoid the risk of an electrical shock or burns.

i The oven lamp is a special electric lamp that can resist up to 300 °C. See Technical specifications, for details.

i Position of lamp might vary from the diagram.

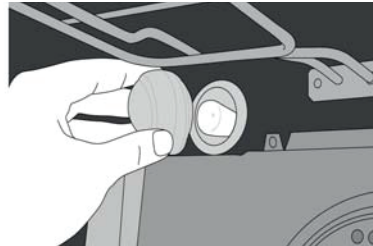

1. Disconnect the product from mains.
2. Turn the glass cover counter clock-wise to remove it.
3. Remove the oven lamp by turning it counter clockwise and replace it with the new one.
4. Install the glass cover

13 - Installation

The product should only be installed by suitably qualified persons.

 The product must be installed in accordance with all local regulations.

 Prior to installation, visually check the product for any damage/defects. Do not install if any issues are found.

Damaged products may cause risks to your own safety.

Before installation

The appliance is intended for installation in Howdens kitchen cabinets.

- Surfaces, synthetic laminates and adhesives used must be heat resistant.
- Kitchen cabinets must be set level and fixed.
- If there is a drawer beneath the oven, a shelf must be installed between oven and drawer.
- The following installation drawings are representational and may not match exactly with your appliance.

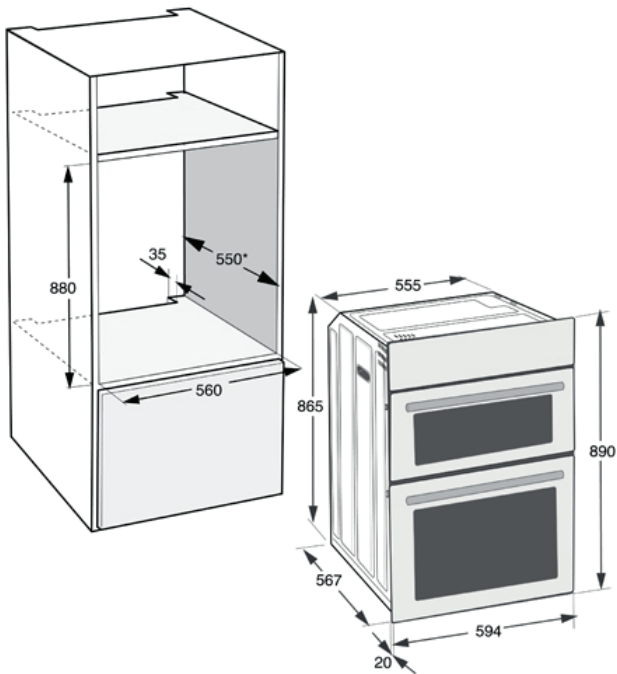

14 - Electrical Connections



IMPORTANT: Ensure that the electricity supply is switched off before connecting. Your oven is intended for permanent installation.

Your appliance must be connected to fixed wiring via the use of a double pole switched outlet with at least 3mm contact separation. The isolation switch must be accessible after installation (see technical data for fuse rating). We recommend the use of an RCD device as additional protection.

We strongly recommend the appliance is connected by a qualified electrician who is a member of the N.I.C.E.I.C who will comply with the I.E.E and any local regulations.

The terminology DOUBLE POLE -/+ means that both the live and neutral supplies are switched and disconnected at the same time.

The terminations labelled SUPPLY are connections for the internal house wiring and the terminations labelled LOAD are for connection to the appliance.

IMPORTANT: The wires in the mains lead are coloured in accordance with the following code:-

Blue..... Neutral

Brown.....Live

Green and Yellow.....Earth

As the colours of the wires in the mains lead of this appliance may not correspond with the coloured markings identifying the terminals in your spur box, proceed as follows;

The wire which is coloured blue must be connected to the terminal which is marked with the letter 'N' or coloured 'BLACK'. The wire which coloured brown must be connected to the terminal which is marked with the letter 'L' or coloured RED. The green and yellow earth 'E' should be connected to the terminal marked with the following symbol .

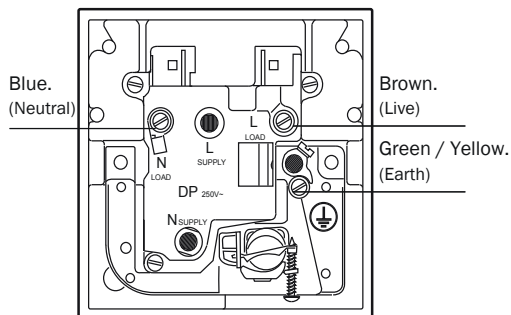

The appliance may be connected to the mains supply only by a competent person.

The mains lead must not be clamped, bent, trapped, or come into contact with hot parts of the appliance.



If the mains lead is damaged, it must be replaced by a qualified person (mains cable must not be longer than 2m for safety reasons). It should be routed away from the appliance and not trapped between the appliance and the wall.

Your oven comes prefitted with a mains cable. If you need to change it:

1. Open the terminal block cover with screwdriver.
2. Pass the mains lead under the cable clamp and secure clamp with the screw over the outer cable insulation
3. Connect the cables according to the supplied diagram.
4. Close the cover of the terminal block once the wiring is complete.
5. Mains cable must not be longer than 2 metres for safety reasons.
6. The mains lead should be routed away from the appliance and not be trapped between the appliance and the wall.

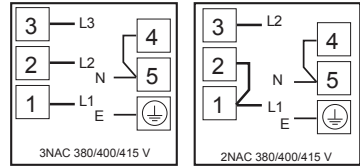
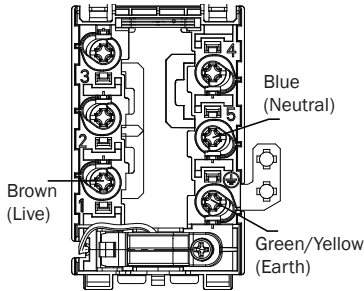

EUROPEAN TERMINALS

Installation

Slide the oven through the cabinet aperture, align and secure.

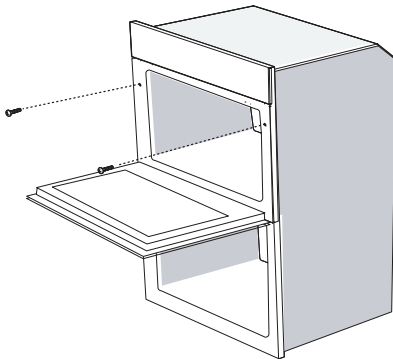

Fix your oven with the 2 screws and washers as indicated in the illustration.

Final check

Connect the appliance to the mains supply, switch on the mains supply and check the oven's functions,

⚠ The clock time must be set in order for the main functions to work. Refer to initial use section for further info.

Cooling fan

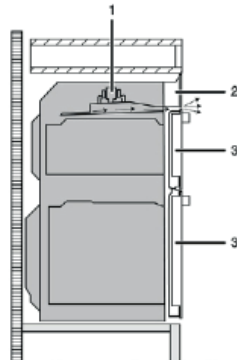

- 1 Fan
- 2 Control panel
- 3 Door

The Built-in cooling fan cools both the front of the appliance and cabinetry.

⚠ Do not switch the oven off at the mains isolation switch immediately after cooking. Cooling fan continues to run for up to 20-30 minutes (approx) even after the oven control is turned off.

15 - Technical specification

TECHNICAL INFORMATION

General

Voltage / Frequency	220-240 V ~ 50 Hz
Total power consumption	3530 - 4200 W
Fuse	Min. 20 A
Cable type / section	H05VV-F 2.5m ² , 3 core or equivalent
Cable length	Max. 2 m

Double Oven/Grill

External dimensions (height / width / depth)	890 mm/594 mm/567 mm
Installation dimensions (height / width / depth)	**890-890 mm/560 mm/min. 550 mm

Main oven	Fan Oven
Inner lamp	15/25 W
Energy consumption fan - forced mode	0.79 kWh / cycle

Top oven	Conventional oven/Grill
Energy consumption conventional mode	0.74 kWh / cycle

Basics: Information on the energy label of electrical ovens is given in accordance with the EN 60350-1/ IEC60350-1 standard. Those values are determined under standard load with bottom-top heater or fan assisted heating (if any) functions.

Energy efficiency class is determined in accordance with the following prioritization depending on whether the relevant functions exist on the product or not. 1-Cooking with eco-fan, 2- Turbo slow cooking, 3- Turbo cooking, 4- Fan assisted bottom/top heating, 5-Top and bottom heating.

** See. Installation section.

- Technical specifications may be changed without prior notice to improve the quality of the product.
- Figures in this manual are schematic and may not exactly match your product.
- Values stated on the product labels or in the documentation accompanying it are obtained in laboratory conditions in accordance with relevant standards. Depending on operational and environmental conditions of the product, these values may vary.

16 - Troubleshooting

TROUBLESHOOTING GUIDE

Symptoms	Possible Cause	Solutions
Oven emits steam when it is in use.	<ul style="list-style-type: none"> Food is being cooked with a high water content 	It is normal that steam escapes from food during cooking. This is not a fault.
Product emits metal noises while heating and cooling.	<ul style="list-style-type: none"> When the oven cavity heats up or cools down parts will expand and contract. 	This is quite normal and the oven is designed to accommodate such movement (this is not a fault).
Product does not operate	<ul style="list-style-type: none"> The mains fuse maybe defective or has tripped Product is not connected properly. 	<p>Check fuses in the fuse box. If necessary, replace or reset them.</p> <p>Check all power connections.</p>
Oven light does not work.	<ul style="list-style-type: none"> Oven bulb is defective Power is cut. 	<p>Replace oven bulb</p> <p>Check if there is power. Check the fuses in the fuse box. If necessary, replace or reset the fuses.</p>
Oven does not heat.	<ul style="list-style-type: none"> Function and/or Temperature are not set. The timer is not adjusted correctly Power is cut. 	<p>Set the function and the temperature with the Function and/or Temperature knob/key.</p> <p>Reset the oven timer.</p> <p>Check if there is power. Check the fuses in the fuse box. If necessary, replace or reset the fuses.</p>



If you cannot eliminate the problem after following the instructions in this section, consult your depot or the Authorized Service Agent. Never try to repair a nonfunctional product yourself.

17 - Your guarantee

Product Guarantee Details (UK only)

Your appliance has the benefit of a comprehensive manufacturer's guarantee which covers the cost of breakdown repairs. (Details of which are shown on your Proof of Purchase Document).

- Any claim during the period of the guarantee (MUST BE ACCOMPANIED BY THE PROOF OF PURCHASE)
- The product must be correctly installed and operated in accordance with the manufacturer's instructions and used for normal domestic purposes.
- This guarantee does not cover accidental damage, misuse or alternations which are likely to affect the product.
- The guarantee is invalid if the product is tampered with, or repaired by any unauthorised person.

(The guarantee in no way affects your statutory or legal rights)

What to do if you need to report a problem-

Please ensure you have ready:

- The product's model and serial numbers
- Howdens Proof of Purchase document
- Your full contact details

Call the Depot number on your Proof of Purchase Document supplied with the product / kitchen.

Or

Call the LAMONA Service Line on 0845 00 60 006

*** Product installed within a domestic kitchen or non-domestic kitchen where 8 or fewer people are using the appliance.**

Where to find the model and serial number on your machine.	Open door, on panel just below door seal main oven.
---	--

PRODUCT FICHE		
Energy Label Directive EU2010/30/EU-No65/2014 of ovens		
Brand	LAMONA	
Model	LAM4603	
Energy Efficiency Index per cavity EEI cavity	94.1	
Energy efficiency class	A	
Energy consumption (kWh)-Conventional per cycle (1)	-	
Energy consumption (kWh)-Forced air convection per cycle (1)	0.79	
Usable volume (litres)	69	
Number of cavity	1.0	
Heat source per cavity	Electrical	x
	Gas	
	Mix	

PRODUCT FICHE		
Energy Label Directive EU2010/30/EU-No65/2014 of ovens		
Brand	LAMONA	
Model	LAM4603	
Energy Efficiency Index per cavity EEI cavity	105.5	
Energy efficiency class	A	
Energy consumption (kWh)-Conventional per cycle (1)	0.74	
Energy consumption (kWh)-Forced air convection per cycle (1)	-	
Usable volume (litres)	36	
Number of cavity	1.0	
Heat source per cavity	Electrical	x
	Gas	
	Mix	

INSTRUCTION BOOKLET		
PRODUCT INFORMATION		
Comply with EU directive 2009/125/EC – Regulation No 66/2014		
Brand	LAMONA	
Model	LAM4603	
Type of oven	Free Standing	
	Built-in	x
Mass of the appliance(M) (Net Weight) kg	48.2	
Number of cavity	1.0	
Heat source per cavity	Electrical	x
	Gas	
	Mix	
Usable volume (litres)	69	
Energy consumption (electricity) required to heat a standardised load in a cavity of an electric heated oven during a cycle in conventional mode per cavity(kWh/cycle)(electric final energy) EC electric cavity	-	
Energy consumption required to heat a standardised load in a cavity of an electric heated oven during a cycle in fan-forced mode per cavity(kWh/cycle)(electric final energy) EC electric cavity	0.79	
Energy consumption required to heat a standardised load in a gas-fired cavity of an oven during a cycle in conventional mode per cavity (MJ/cycle) (kWh/cycle)(gas final energy) EC gas cavity (1)		
Energy consumption required to heat a standardised load in a gas-fired cavity of an oven during a cycle in fan-forced mode per cavity (MJ/cycle) (kWh/cycle)(gas final energy) EC gas cavity (1)		
Energy Efficiency Index per cavity EEI cavity	94.1	
(1) 1 kWh/cycle = 3,6 MJ/cycle.		

INSTRUCTION BOOKLET		
PRODUCT INFORMATION		
Comply with EU directive 2009/125/EC – Regulation No 66/2014		
Brand	LAMONA	
Model	LAM4603	
Type of oven	Free Standing	x
	Built-in	
Mass of the appliance(M) (Net Weight) kg	48.2	
Number of cavity	1.0	
Heat source per cavity	Electrical	x
	Gas	
	Mix	
Usable volume (litres)	36	
Energy consumption (electricity) required to heat a standardised load in a cavity of an electric heated oven during a cycle in conventional mode per cavity(kWh/cycle)(electric final energy) EC electric cavity	0.74	
Energy consumption required to heat a standardised load in a cavity of an electric heated oven during a cycle in fan-forced mode per cavity(kWh/cycle)(electric final energy) EC electric cavity	-	
Energy consumption required to heat a standardised load in a gas-fired cavity of an oven during a cycle in conventional mode per cavity (MJ/cycle) (kWh/cycle)(gas final energy) EC gas cavity (1)		
Energy consumption required to heat a standardised load in a gas-fired cavity of an oven during a cycle in fan-forced mode per cavity (MJ/cycle) (kWh/cycle)(gas final energy) EC gas cavity (1)		
Energy Efficiency Index per cavity EEI cavity	105.5	
(1) 1 kWh/cycle = 3,6 MJ/cycle.		

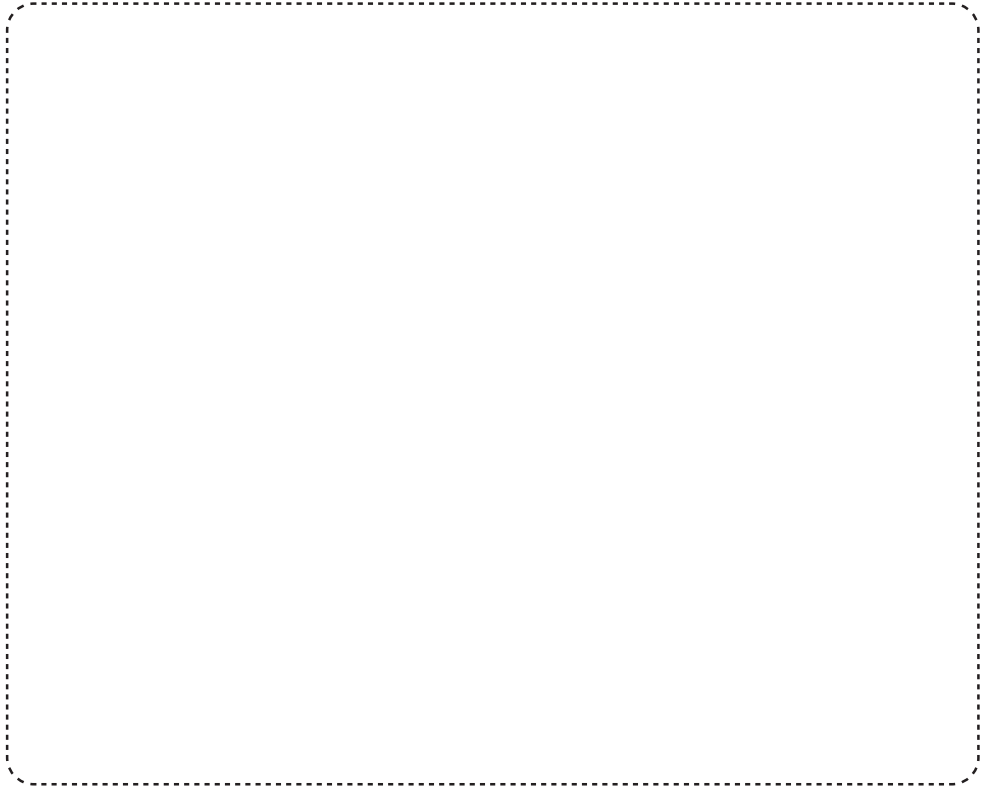

Product serial number
(Place sticker here)

LAMONA
Exclusive to Howdens Joinery Co.

ISSUE v5 250117