

LAMONA

at the heart of the kitchen

T-Box Island Hood

LAM2851



Instructions and Installation

Register 
my appliance

www.howdens.com/appliances-registration

ISSUE v5.1 090522



Free 3 year guarantee

Call now¹

Within the UK:

0333 010 0009

Within Republic of Ireland:

01525 5752

Alternatively, visit www.howdens.com/appliance-registration

LAMONA

**3 year guarantee available.
Register your appliance within 90 days²**

By registering your appliance and creating an account, we will keep you up to date with the latest product information and notify you immediately of any important product updates

¹Lines are open Monday to Friday 9am to 5pm. Calls will be charged at your local rate and may be recorded and monitored for training and quality purposes.

²So that in the event of an important product update, or recall, we can contact you.

Register 
my appliance

Dear Customer,

Congratulations on your choice of a LAMONA domestic appliance.

The user manual will help you use your product quickly and safely.

- Please read this user manual before installing and using the product.
- Always follow the safety instructions.
- Keep this user manual within easy reach for future reference.
- Please read any other documents supplied with the product.

Explanation of symbols

Throughout this user manual the following symbols are used:



Important information or useful tips about usage.



Warning for possible hazards to health and property.



Warning possibility of electric shock.

Energy Efficiency

In order to optimise efficiency of the product and reduce environmental impact we recommend the following:

- Product is installed in ducted configuration, using maximum Ø of ducting advised in this manual, ducting as straight and as short as possible.
- Any filters are cleaned/replaced when necessary to maintain good airflow and grease filter efficiency.
- Switch on the hood at the minimum speed required to clear unwanted cooking odours.
- Switch off lighting when not in use or not required.

Metal Surfaces of the Extractor and Condensation

When cooking with pans using a large water content, large quantities of vapour and steam can be produced very quickly. This steam may condense onto the cold metallic surfaces of the extractor and even the splash back area if tiled, glazed etc.

(This is not a fault with either the hob or extractor if correctly installed).

The amount of this condensation on any particular surface will depend on many factors including the ambient temperature in the kitchen, the related ambient temperature of the metal surfaces, the general ventilation within the kitchen, the type of food being cooked and the duration. Using lids on pans can help reduce the amount of steam being released and subsequent condensation.



This appliance is marked according to the European Directive 2012/19/EU on Waste Electrical and Electronic Equipment (WEEE). By ensuring this product is disposed of correctly you will help prevent potential negative consequences for the environment and human health. The symbol on this product indicates that this product may not be treated as household waste. Instead it should be handed over to the applicable collection point for recycling or electrical and electronic equipment. Disposal must be carried out in accordance with local environmental regulations for waste disposal. For more detailed information please contact your local council household waste site.

By placing the  marking on this product, we declare, on our own responsibility, compliance to all of European safety, health and environmental requirements stated in the legislation for this product.

Index

Before using the extractor	05
Safety	05
Fire safety	06
Ventilation	06
Important safety information	07
Electrical safety	07
General information & operation	08
Extractor contents	08
Control panel layout	08
Using your cooker hood	09
Speed selection	09
Light control	09
Remote controls	09
Battery	10
Connecting the remote control	10
Care and maintenance	11
General cleaning	11
Grease filters	11
Carbon filters	12
Replacing the lamps	12
Installation	13
Methods of extraction	13
Extraction via ducting	13
Extraction via recirculation	13
Before beginning installation	14
Installation fixing method outline	15
Installation	16
Building and fixing the extractor	17-18
Electrical connections	19
Technical specifications	20
Trouble shooting	21
Your guarantee	22

Before using the Extractor

- Make sure that you have removed all packaging, wrappings, stickers and films from the Extractor.
- It is recommended that you clean the extractor's surface before using for the first time.

Safety

Important!

Always switch off the electricity supply at the mains during installation, maintenance and cleaning.

- This appliance can be used by children aged from 8 years and above and persons with reduced physical, sensory or mental capabilities or lack of experience and knowledge if they have been given supervision or instruction concerning use of the appliance in a safe way and understand the hazards involved. Children shall not play with the appliance. Cleaning and user maintenance shall not be made by children without supervision.

- **Caution:** The appliance and its accessible parts can become hot during operation. Children younger than 8 years old should stay away unless they are under permanent supervision.

- The cooker hood must be installed in accordance with the

instructions and all measurements followed.

- All installation work must be carried out by a competent person or qualified electrician.

- Please dispose of the packing material carefully. Children are vulnerable to it.

- Pay attention to the sharp edges inside the cooker hood especially during installation and cleaning.

- If the cooker hood is damaged, do not attempt to use.

- If the supply cord is damaged, it must be replaced by the manufacturer, its service agent or similarly qualified persons in order to avoid a hazard.

- Cooker hood is for domestic use only (see guarantee page for definition).

- Use suitable and appropriate fittings for mounting the hood.

Important Safety Information

Fire Safety

- Do not leave frying pans unattended during use because overheated fats or oils might catch fire.

- Never leave naked flames under the cooker hood.

- There is a fire risk if cleaning is not carried out in accordance with the instructions.

- Do not flambé under the cooker hood.

- Do not use the cooker hood without the grease filter fitted.

- The minimum distance between the pan supports on the hob and the lowest part of the cooker hood. (When the cooker hood is located above a gas appliance) shall be a minimum of 650mm. (Coal or oil 750mm)

Ventilation

- There shall be adequate ventilation of the room when the cooker hood is used at the same time as appliances burning gas or other fuels.

- When in extraction mode, air in the room is being removed by the cooker hood. Please make sure that proper ventilation measures are being observed. The cooker hood removes odours from room but not steam.

- The air must not be discharged into a flue that is used for exhausting fumes from appliances burning gas or other fuels.

- Make sure the ducting has no bends sharper than 90 degrees as this will reduce the efficiency of the cooker hood (max duct length 3m, 150mm Ø).

- Always put lids on pots and pans when cooking.

- Large quantities of vapour and steam can be produced very quickly. This steam may condense onto the cold metallic surfaces of the extractor (This is not a fault with either the hob or extractor if correctly installed.) The amount of this condensation on any particular surface will depend on many factors including the general ventilation within the kitchen, the type of food being cooked and the duration.

Important Safety Information

Using lids on pans can help reduce the amount of steam being released and subsequent condensation.

Induction hobs offer a powerful, more efficient heating process but do not generate the higher levels of ambient heat that would normally help dissipate vapour and steam as with older hob technology.

- The manufacturer refuses to accept any responsibility for damage to or damages arising from failure to observe this instructions.

- Ensure the ducting for cooker hood has the same diameter all the way through and at the outlet.

- If the cooker hood is installed for use above a gas appliance then the provision for ventilation must be in accordance with the Gas Safety Codes of Practice BS.6172, BS.5440 & BS.6891 (Natural Gas) and BS.5482 (LP Gas) 1994, the Gas Safety (Installation & Use) Regulations, the Building Regulations issued by the Department of the Environment, the Building Standards (Scotland) (Consolidated) Regulations issued by the Scottish Development Department.

- Do not use high level grills or BBQ type products under this extractor.

Electrical Safety

- In case of any damage, switch off the product and disconnect it from the mains. To do this, turn off the fuse at the fuse box. Make sure that fuse rating is compatible with the product.

General Information & Operation

Extractor Contents



Reducer

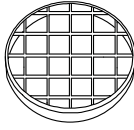

Cable grid



Struts x 8

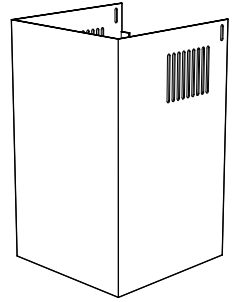
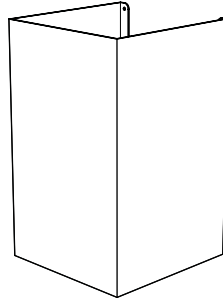

Chimney sections

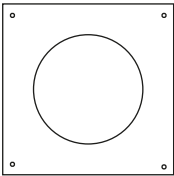

Ceiling plate



Fixings

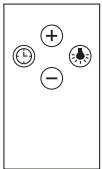

Remote control

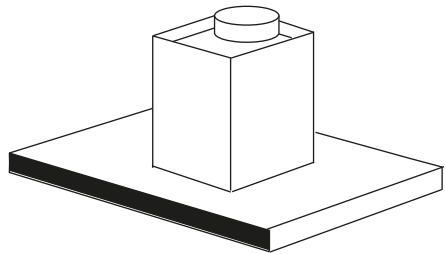

Main body

Control Panel Layout

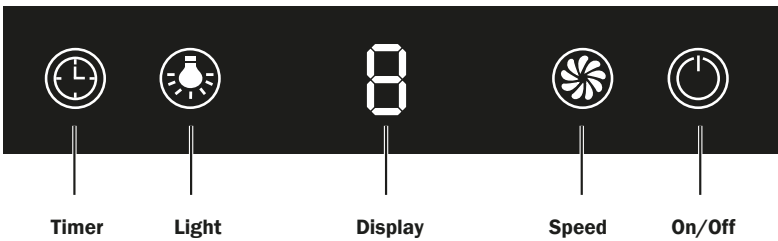

Timer

Light

Display

Speed

On/Off

Using Your Cooker Hood

Make sure that it has been installed by a suitably qualified person, as per the installation instructions.

 Ideally you should turn on your hood ten minutes before you start to cook, or at the very least when you begin cooking. You should also run your hood for ten minutes after you have finished cooking.

 Caution - Accessible parts may become hot when used with cooking appliances.

Induction Hobs - Metal Surfaces of the Extractor and Condensation

Large quantities of vapour and steam can be produced very quickly. This steam may condense onto the cold metallic surfaces of the extractor and even the splash back area if tiled, glazed etc. (This is not a fault with either the hob or extractor if correctly installed).

The amount of this condensation on any particular surface will depend on many factors including the general ventilation within the kitchen, the type of food being cooked and the duration. Using lids on pans can help reduce the amount of steam being released and subsequent condensation. Induction hobs offer a powerful, more efficient heating process but do not generate the higher levels of ambient heat that would normally help dissipate vapour and steam as with older hob technology.

Speed Selection

- If you press the selection button once, the motor will run at low speed.
- Press the speed selection button twice and the motor will run at medium speed.
- Press the speed selection button three times and the motor will run at high speed. Another press of the button will return the motor to low speed.
- To turn off the hood, press the on/off button. The speed and power symbols will disappear.
- When you next press the on/off button, the cooker hood will continue working at the speed it last selected set on.

Light Control

- Touch the light on/off button once, to turn on the cooker hood lights and touch again to turn off.

Remote Controls



Press the button once, the light activates, press the button again, the light will be turned off. The lighting button is controlled separately and will not effect any other functions.



Turning On / Increasing Fan Speed:

1st Press, LOW speed, 2nd Press, MEDIUM speed, 3rd Press, HIGH speed



Turning Off / Decreasing Fan Speed

Press the button and the motor begins to adjust to a lower setting and the LCD screen displays the speed. If it is pressed again it will decrease to the 'off' setting.



Timer

Press the timer button, this turns the timer setting function on / off. Timer function will run for a period of 9 minutes, at the end the cooker hood will switch off.

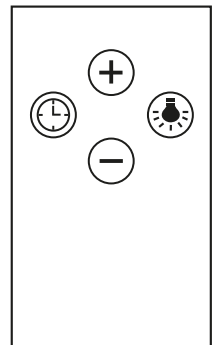



Battery

The remote control requires a CR2025 battery. The battery can be accessed from the bottom, as shown in the below picture.

Carefully release the tab and pull the battery tray out.



 BATTERY WARNING	
<p>KEEP OUT OF REACH OF CHILDREN Swallowing can lead to chemical burns, perforation of soft tissue, and death. Severe burns can occur within 2 hours of ingestion. Seek medical attention immediately.</p>	

No obvious symptoms

Unfortunately, it is not obvious when a button or coin battery is stuck in a child's oesophagus (food pipe). There are no specific symptoms associated with this. Your child might:

- point to their throat or stomach;
- have a pain in their abdomen, chest or throat;
- be tired or lethargic;
- cough, gag or drool a lot;
- appear to have stomach upset or a virus; or be sick.
- be quieter or more clingy than usual or otherwise "not themselves";
- lose their appetite or have a reduced appetite; and
- not want to eat solid food / be unable to eat solid food.

These sorts of symptoms vary or fluctuate, with the pain increasing and then subsiding.

A specific symptom to button and coin battery ingestion is vomiting fresh (bright red) blood. If the child does this seek immediate medical help.

The lack of clear symptoms is why it is important to be vigilant with "flat" or spare button or coin batteries in the home and the products that contain them.



Connecting The Remote Control

A new remote control has to establish a connection to the cooker hood when used for the first time. (One remote control could possibly control several cooker hoods at the same time).

Connection Process Between Remote Control And Cooker Hood:

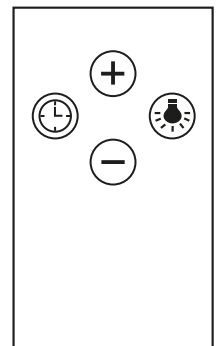
1. Press any button on the LCD touch control panel on the cooker hood, the backlight display is lit and the cooker hood is in stand-by mode.
2. Press  for 10 seconds, the indicator lights begin flashing from one button to another:- the cooker hood is in connection mode. The press any button on the remote control to confirm the connection. The connection process is finished and the remote can be used for speed selection, lighting and timer setting.
3. If you want to connect again you will need to clear the code that has been entered previously:



To clear: Press the  for 10 seconds, the indicator lights begin flashing one button to another:- the cooker is in connection mode. Then, press the  for 10 seconds immediately again: the previous connection code is cleared

To After the previous connection code is cleared. Press  for 10 seconds:- the indicator lights begin flashing from one button to another:- the cooker hood is in connection mode. Then press any button of the remote control to confirm connection.

Care and Maintenance

 **Before cleaning or attempting any type of maintenance, always make sure that the electricity supply is disconnected.**

To avoid the possibility of fire, adhere strictly to all of the recommendations included in this booklet, paying particular attention to the grease filters to ensure grease deposits do not build up.

The manufacturer declines all liability in cases where the instructions for the appropriate installation, maintenance and use of the extractor hood are not observed.

If the power cable is cut or damaged in any way, disconnect the extractor from the electricity supply and call the service number on the rear cover of this booklet or a suitably qualified repairer.

General Cleaning

Wipe the external surfaces of the appliance regularly using warm water and a mild detergent. NEVER use abrasive cleaners.

The Grease Filters

Your extractor includes a grease filter which helps to protect your kitchen & furniture from greasy residues by filtering out grease particles.

- Over time, the grease filter may become a fire risk if the greasy residue is allowed to build up.
- To prevent a fire hazard, the grease filter should be cleaned.
- Depending on use, this should be done every 10-15 days or for light usage once a month.
- First remove the grease filters by pushing the in the button on the handle and pulling the filter away from the cooker hood.
- Soak the grease filters in hot water and washing up liquid for at least 3 minutes. The use a soft brush to loosen any grease deposits that have formed. Rinse the filters thoroughly with hot water. Repeat the process if necessary.
- Allow the grease filter to dry completely before refitting.
- The extractor must never be operated without the grease filter in position.
- If grease filters are washed in a dishwasher (60 °c) the plastic may discolour

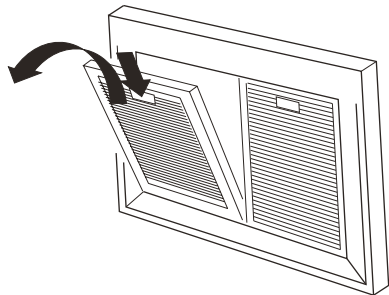

The Carbon Filter

If the appliance is going to be used in recirculation mode then it is necessary to fit carbon filter. This will help absorb odours caused by cooking.

Carbon filters have a limited life. We advise you to change them when there is a noticeable drop in performance. The intervals between changing the filter will depend entirely upon the amount of cooking you do, but on average they will last about 3-6 months.

- To gain access to the carbon filter, first of all remove the grease filters as mentioned previously.
- Remove the old filter and install new charcoal filter by unlocking / locking the filter with the centre fixings (filter part number LAM2002).
- The carbon filter is not washable and cannot be recycled.

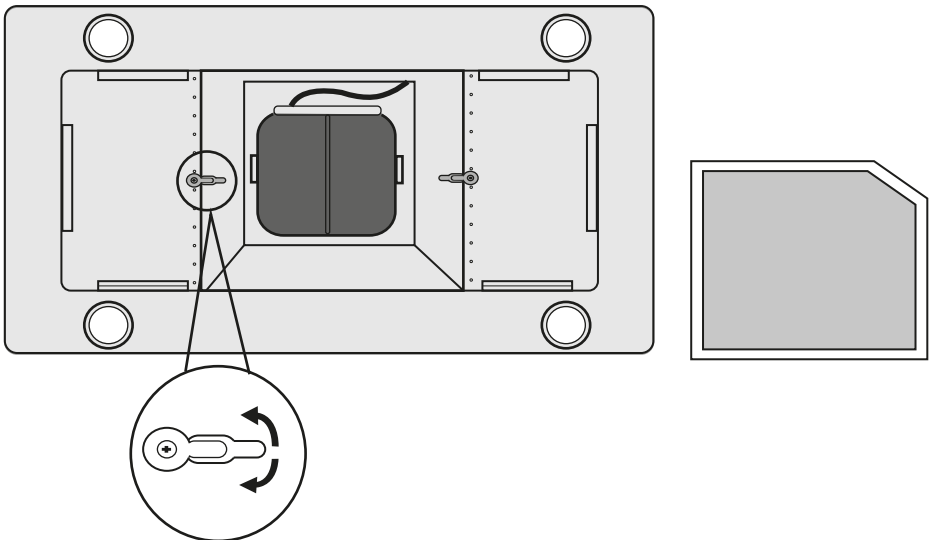

Replacing the Lamps

The cooker hood uses LED lamp modules which are not replaceable by the user. Please contact the service line if a lamp fails / needs replacing. This product contains a light source with energy efficiency of A.

 The lamps on this appliance should only be used during operation of the cooker hood. They should not be left on permanently and used as a main lighting source. The extractor is for domestic



Installation

Methods of Extraction

The very best method of clearing the kitchen of unwanted odours is by connecting the appliance to an exhaust duct and venting to the outside atmosphere via the ceiling or an exterior wall. (Suitable ducting kits may be purchased from the depot where you bought the extractor.) You do not need charcoal filters when using the external ducting mode.

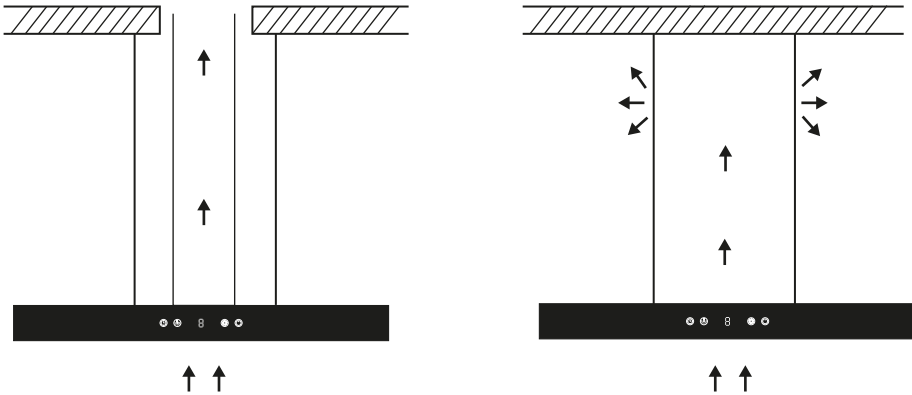

Extraction Via Ducting

Never use the hood in areas where devices with exhaust pipes connected to the outside are already operating unless perfect ventilation can be guaranteed.

- Connect the external ducting kit to the outlet of the extractor.



Carbon filter is not required if the extractor is to be ducted out.

- Do not connect the ducting system of this appliance to any existing ventilation system which is being used for any other purpose.
- The air must not be discharged into a flue that is used for exhausting fumes from appliances burning gas or other fuels (not applicable to appliances that only discharge the air back into the room).
- Keep ducting as short as possible, with the minimum number of bends, for the best airflow (max 3 metres).

Extraction Via Recirculation

For extraction via recirculation, attach carbon filter inside the hood.





(Part reference LAM2002)



Before attempting to change or fit the charcoal filter ensure power to the extractor is switched off.

- Remove the grease filters.
- Turn the retaining clips to release the filter.
- Insert new filter, turn retaining clips to fasten.
- Replace the grease filters before the power supply is turned back on.
- Performance will be reduced when used in recirculation mode, or if using long lengths of ducting.

Before Beginning Installation



-  Check that the product purchased is of a suitable size for the chosen installation area. In addition check whether there is an electrical socket available that will be accessible once the hood is mounted. If the product is going to be used in extraction mode, then there should also be space to connect a ducting hose to the outside.
-  Carry out all necessary masonry work prior to the fitting of the cooker hood and cabinetry.
-  Ensure that all electrical connections are carried out by a suitably qualified person.
 - Check inside the product and ensure that there is no transit packaging or any other materials, such as packets of screws, guarantees etc. These should be removed and kept for future use.
-  Protect any hob already installed below with a blanket or cardboard etc, to prevent possible damage.
 - The maximum distance between the cooker hood and your discharge outlet should be 3 metres, with one 90 degree bend. For each additional 90 degree bend, the maximum distance is reduced by a metre. Use 150mm ducting for optimum performance.
-  **Use appropriate fixings for ceiling construction type.**

Cable Grid - Recirculation Mode

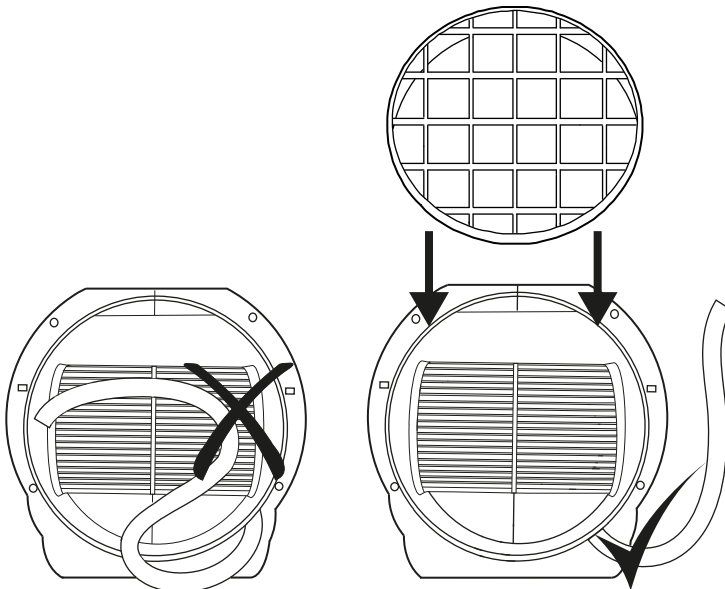
To ensure that mains cable does not fall and enter the motor housing, fit the cable grid.



Installation - Fixing Method Outline

1. Prepare venting (if applicable).
2. Prepare electrical connection point. 
3. Securely fasten top plate to the ceiling (top fixing or extractor body fixing method).
4. Build extractor body and frame (top fixing or extractor body fixing method).
5. Lift and fasten extractor to ceiling (connect vent kit if applicable).  **CAUTION HEAVY!**
6. Connect to a electrical point (power turned off at fuse or breaker). 
7. Secure chimney sections.
8. Insert carbon filter if applicable.
9. Replace grease filters.
10. Power on at fuse or breaker.

 **CAUTION:** Ceiling must be able to bear a load of at least 120kg, and be a thickness of at least >30mm.

Installation

The ceiling height (A) determines the method of installation.

If ceiling height is less than 2.45m:

'Top plate' fixing method (3 x person fit)

Fasten plate to ceiling, struts fasten to extractor, chimney slides over struts, lift whole unit up to fasten to ceiling plate.

If ceiling height is more then 2.45m:

'Extractor body' fixing method (2/3 x persons fit - slightly easier)

Plate & struts fasten to ceiling, chimney sections are placed over struts and secured, then extractor is lifted up to struts and fastened.

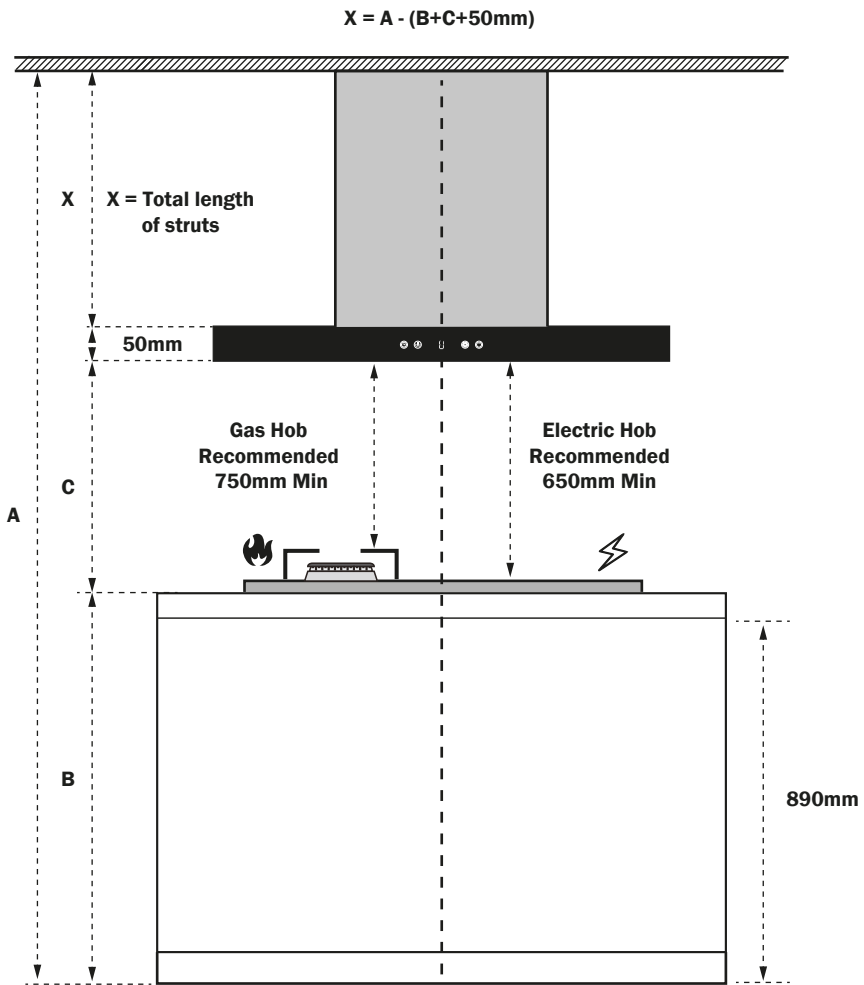

Installation - Building & Fixing Your Extractor

Based on the standard Howdens Kitchen Installation Manual set-up of:

Base unit height	890mm
Worktop*	40mm (dependant on worktop chosen)
Rec. Hob Clearance*	750mm (*Can be reduced to 700mm as a minimum dimension)
	=1680mm (Height from floor to base of extractor)

2.4m - Ceiling Height Set-Up (= 'Top Plate' Fixing)

Build extractor and struts to height of c.720mm

Struts length set to c. 660mm

2.31m - Minimum Ceiling Height Possible (= 'Top Plate' Fixing)

Use single struts. Overall extractor height of c. 630mm

(Height is suitable for recirculation installation)

Ceiling plate only fastens to the ceiling, assembled extractor and chimney sections are lifted to fasten to ceiling plate. Upper chimney section is lifted and secured to ceiling plate.

Using M4 (10mm) Screws, washers and nuts

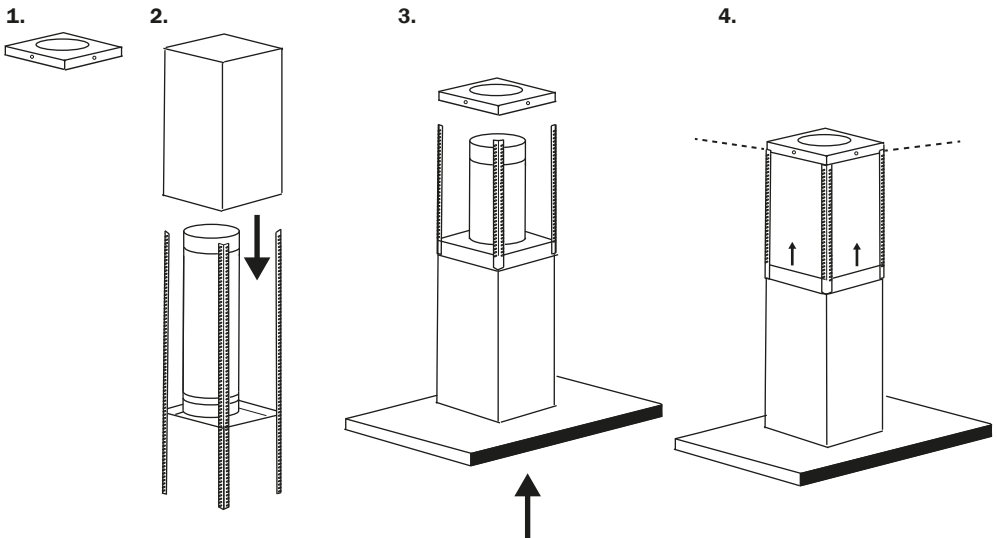

- * Remove any loose / dropped screws and nuts etc to avoid possible vibrations / rattles
- * Struts must have min. 100mm overlap

Installation - Building & Fixing Your Extractor

2.69m - Maximum Height Set-Up (= 'Extractor body' fixing)

Build ceiling plate and struts to c.1016mm

Struts length set to c. 957mm (*100mm minimum strut overlap is necessary)

2.46m - Minimum height for 'Extractor body' fixing

Build ceiling plate and struts to c.780mm

Struts length set to c. 715mm

Note:

Lowest strut jointing nuts and bolts need to be set

c.270mm from the bottom of the strut to allow fixing to extractor body.

Ceiling plate with struts fasten to the ceiling, chimney sections are placed over the struts and secured. Extractor body and glass is lifted to struts and secured. Chimney section lowers.

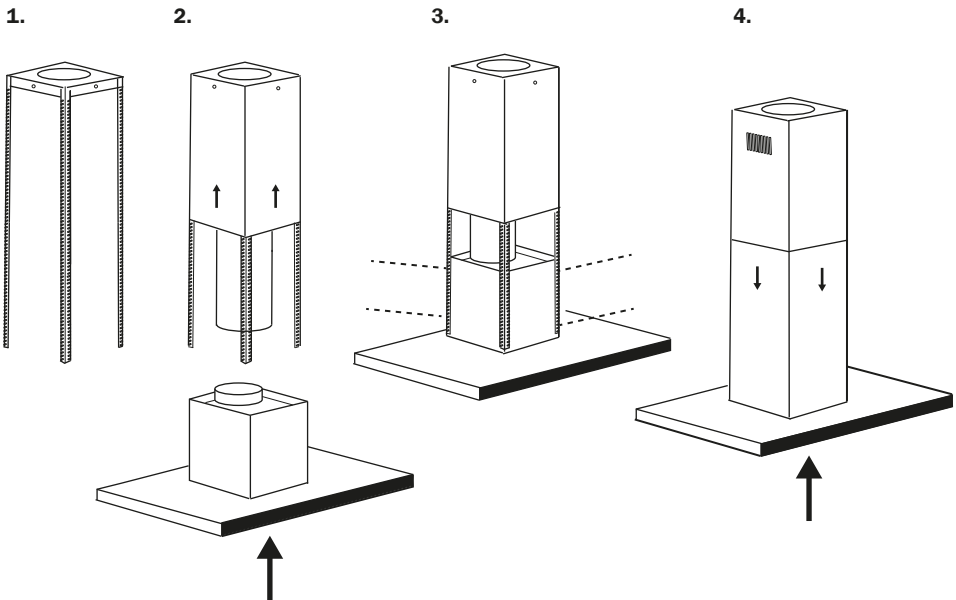

- * Remove any loose / dropped screws and nuts etc to avoid possible vibrations / rattles
- *Struts must have min. 100mm overlap

Electrical Connections



IMPORTANT: Ensure that the electricity supply is switched off before connecting.

Your appliance must be connected to fixed wiring via the use of a double pole switched fused spur outlet with at least 3mm contact separation. The isolation switch must be accessible after installation. (See technical data for fuse rating). We recommend the use of an RCD device as additional protection.



The terminology DOUBLE POLE +/- means that both the live and neutral supplies are switched and disconnected at the same time.

The terminations labelled SUPPLY are the connections for the internal house wiring and the terminations labelled LOAD are for connection to the appliance.

IMPORTANT: The wires in the mains lead are coloured in accordance with the following code:-

Blue.....Neutral

Brown.....Live

Green / Yellow.....Earth

As the colours of the wires in the mains lead of this appliance may not correspond with the coloured markings identifying the terminals in your spur box, proceed as follows;

The wire which is coloured blue must be connected to the terminal which is marked with the letter 'N' or coloured BLACK. The wire which is coloured brown must be connected to the terminal which is marked with the letter 'L' or coloured RED. The wire which is coloured GREEN / YELLOW must be connected to the terminal marked 

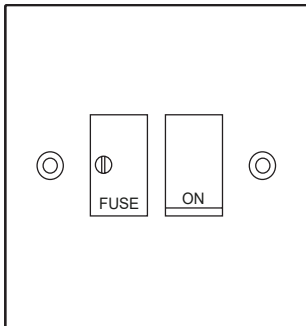

Fig 3.

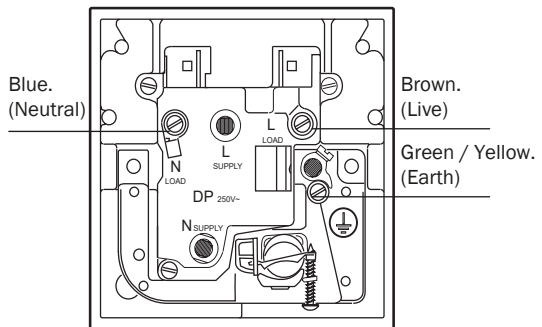

Fig 4.

Technical Specification

TECHNICAL INFORMATION

Dimensions:	
Total Wattage:	236W
Voltage:	220V - 240V 50HZ
Width :	900mm
Depth :	600mm

Your Cooker Hood is fitted with:

- Single motor 230W
- Touch control with remote control
- 3 Speed extraction
- x4 LED lamps (DSR - 1.5/30-S-64)
- x3 Aluminium grease filters

Optional Extras:

Charcoal filter :	LAM2002 (PK1)
Ducting kits :	APL 2805/6

Troubleshooting

TROUBLESHOOTING GUIDE

Symptoms	Possible Cause	Solutions
Product does not operate	<ul style="list-style-type: none"> • Mains fuse or breaker has tripped. 	<ul style="list-style-type: none"> • Check extractor for any obvious issues. • Replace fuse / reset breaker.
Lamp does not operate	<ul style="list-style-type: none"> • Defective lamp module. 	<ul style="list-style-type: none"> • Call service line.
Poor extractor performance	<ul style="list-style-type: none"> • Clogged filters. • Vent ducting; too long, too small diameter, too many bends. • Extractor mounted too high above the hob. 	<ul style="list-style-type: none"> • Wash grease filters. • Change carbon filters (if applicable). • Check installation.
Smells linger	<ul style="list-style-type: none"> • Clogged filters. 	<ul style="list-style-type: none"> • Wash grease filters. • Change carbon filters (if applicable).

-  If you cannot eliminate the problem after following the instructions in this section, consult your depot or the Service line.

Your Guarantee

Product Guarantee Details (UK & Republic of Ireland only)

Your appliance has the benefit of a comprehensive manufacturer's guarantee which covers the cost of breakdown repairs. (Details of which are shown on your Proof of purchase Document).

- Any claim during the period of the guarantee MUST BE ACCOMPANIED BY THE PROOF OF PURCHASE.
- The product must be correctly installed and operated in accordance with the manufacturer's instructions and used for normal domestic purposes.
- This guarantee does not cover accidental damage, misuse or alterations which are likely to affect the product.
- The guarantee is invalid if the product is tampered with, or repaired by any unauthorised person.

(The guarantee in no way affects your statutory or legal rights).

What to do if you need to report a problem.

Please ensure you have ready:

- The product's model and serial numbers.
- Howdens Proof of Purchase Document.
- Your full contact details.

Call the Depot number on your Proof of Purchase Document supplied with the product / kitchen.

or

Call the LAMONA service line on:

Within the UK: 0344 460 0006

Within Republic of Ireland: 01525 5703

*Product installed within a domestic kitchen or a non-domestic kitchen where 8 or fewer people are using the appliance.

<p>Where to find the model and serial number on your machine.</p>	<p>Remove grease filters - sticker in the motor cavity area.</p>
--	---



Product serial number
(Place sticker here)

LAMONA
at the heart of the kitchen



Howden Joinery Ltd, Thorpe Road, Howden, East Yorkshire, DN14 7PA
Imported in EU by: Houdan Cuisines SAS, Z.A. du Bois Rigault Nord,
1Rue Calmette, 62880 Vendin-le-Vieil, Cedex, France.

Product information correct at the time of publication in March 2022.
The company has a policy of continuous product development and reserves the right to change any products and specifications given in this manual. Subject to the Terms and Conditions of Trading, a copy of the Howdens Terms and Conditions is available upon request.

Copyright © 2022 Howden Joinery Ltd. All rights reserved.