

---

# Cooker Hood

LAM2875  
LAM2876



User Manual

---

**LAMONA**

Exclusive to Howdens Joinery Co.

Register  
my appliance ✓

[www.howdens.com/appliance-registration](http://www.howdens.com/appliance-registration)

---

# Register my appliance

Register your Lamona appliance purchased from Howdens Joinery to allow us to easily contact you in the event of important product updates at:

[www.howdens.com/appliance-registration](http://www.howdens.com/appliance-registration)

## LAMONA

Exclusive to Howdens Joinery Co.

See back page for product serial number

# Contents

Safety information	4
Safety Instructions	6
Installation	7
Product description	8
Daily use	8
Care and cleaning	9
Troubleshooting	11
Your guarantee	12

Subject to change without notice.

## Safety information

Before the installation and use of the appliance, carefully read the supplied instructions. The manufacturer is not responsible for any injuries or damages that are the result of incorrect installation or usage. Always keep the instructions in a safe and accessible location for future reference.

### **Children and vulnerable people safety**

- This appliance can be used by children aged from 8 years and above and persons with reduced physical, sensory or mental capabilities or lack of experience and knowledge if they have been given supervision or instruction concerning the use of the appliance in a safe way and understand the hazards involved.
- Children between 3 and 8 years of age and persons with very extensive and complex disabilities shall be kept away from the appliance unless continuously supervised.
- Children of less than 3 years of age should be kept away from the appliance unless continuously supervised.
- Do not let children play with the appliance.
- Keep all packaging away from children and dispose of it appropriately.
- Keep children and pets away from the appliance when it operates.
- Children shall not carry out cleaning and user maintenance of the appliance without supervision.

### **General Safety**

- This appliance is intended for domestic use above hobs, cookers and similar cooking devices.
- Before carrying out any maintenance, disconnect the appliance from the power supply.
- CAUTION: Accessible parts may become hot during use with cooking appliances.

- Use only the fixing screws supplied with the appliance if not supplied, use the screws recommended in the installation instructions.
- Do not use adhesives to fix the appliance.
- The minimum distance between the hob surface on which the pans stand and the lower part of the appliance shall be at least 65 cm, unless otherwise specified in the installation instructions for the appliance or hob.
- The discharge of air must comply with local authorities regulations.
- Ensure good air ventilation in the room where the appliance is installed to avoid the backflow of unwanted gases into the room from appliances burning gas or other fuels, including open fires.
- Make sure that the ventilation openings are not blocked and the air collected by the appliance is not conveyed into a duct used to exhaust smoke and steam from other appliances (central heating systems, thermosiphons, water-heaters, etc.).
- When the appliance operates with other appliances the maximum vacuum generated in the room should not exceed 0.04 mbar.
- Make sure not to cause damage to the mains cable. Contact our Authorised Service Centre or an electrician to change a damaged mains cable.
- If the appliance is connected directly to the power supply, the electrical installation must be equipped with an isolating device that allows to disconnect the appliance from the mains at all poles. Complete disconnection must comply with conditions specified in the overvoltage category III. The means for disconnection must be incorporated in the fixed wiring in accordance with the wiring rules.
- Do not flambé under the appliance.
- Do not use to exhaust hazardous or explosive materials and vapours.
- Clean the appliance regularly with a soft cloth to prevent the deterioration of the surface material.

- Do not use a steam cleaner, water spray, harsh abrasive cleaners or sharp metal scrapers to clean the surface of the appliance. Use only neutral detergents.
- Clean grease filters regularly (at least every 2 months) and remove grease deposits from the appliance to prevent the risk of fire.
- Use a cloth or brush to clean the interior of the appliance.

## Safety Instructions

### Installation



**WARNING!** Risk of injury, electric shock, fire, burns or damage to the appliance.

- Only a qualified person must install this appliance.
- Do not install or use a damaged appliance.
- Follow the installation instructions supplied with the appliance.
- Always take care when moving the appliance as it is heavy. Always use safety gloves and enclosed footwear.
- Before installing the appliance remove all the packaging, the labelling and the protective film.
- Do not install the exhaust air into a wall cavity, unless the cavity is designed for that purpose.

### Electrical connection



**WARNING!** Risk of fire and electric shock.

- All electrical connections should be made by a qualified electrician.
- Make sure that the parameters on the rating plate are compatible with the electrical ratings of the mains power supply.
- If the symbol (⏏) is not printed on the rating plate, the appliance must be earthed.
- Always use a correctly installed shockproof socket.
- Do not let the electricity mains cable tangle.
- Do not use multi-plug adapters and extension cables.
- If the mains socket is loose, do not connect the mains plug.
- Do not pull the mains cable to disconnect the appliance. Always pull the mains plug.
- The shock protection of live and insulated parts must be fastened in such a way that it cannot be removed without tools.
- Make sure the appliance is installed correctly. Loose and incorrect electricity mains cable can make the terminal become too hot.
- Connect the appliance at the end of the installation. Make sure that there is access to the mains after the installation.

## Use



**WARNING!** Risk of injury, burns and electric shock.

- This appliance is for cooking purpose only. Do not use the appliance for other purpose.
- Do not change the specification of this appliance.
- Do not operate the appliance with wet hands or when it has contact with water.
- Use only the accessories supplied with the appliance.
- Keep flames or heated objects away from fats and oils during cooking and frying.
- Do not use uncovered electric grates.
- Do not use the appliance as a storage surface.
- Do not use magnifying glasses, binoculars or similar optical devices to look directly at the lighting of the appliance.

## Service

- To repair the appliance contact the Authorised Service Centre.
- Use original spare parts only.

## Disposal



**WARNING!** Risk of injury or suffocation.

- Contact your municipal authority for information on how to discard the appliance correctly.
- Disconnect the appliance from the mains supply.
- Cut off the mains electrical cable close to the appliance and dispose of it.

# Installation



**WARNING!** Refer to Safety chapters.

## Installation instructions



For complete information about the installation of the appliance refer to a separate installation booklet.

# Product description

## General overview

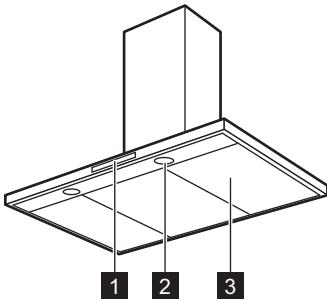

- 1 Control panel
- 2 Lamp
- 3 Filter

## Control panel overview

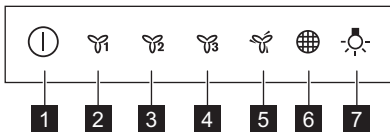



- 1 On / Off
- 2 First motor speed
- 3 Second motor speed
- 4 Third motor speed
- 5 Maximum motor speed
- 6 Filter alarm indicator
- 7 Lamp

# Daily use

## Using the hood



Check the recommended speed according to the table below.

	While heating up food, cooking with covered pots.
	While cooking with covered pots on multiple cooking zones or burners, gentle frying.
	While boiling, frying big quantities of food without a lid, cooking on multiple cooking zones or burners.







While boiling, frying big quantities of food without a lid, big humidity. The hood operates on maximum speed. After 10 minutes the appliance returns to previous setting.





-  It is recommended to leave the hood operating for approximately 15 minutes after cooking.
-  The control Panel is a sensor field. Touch the symbols to activate the functions.

To operate the hood:

1. Turn on the appliance by pressing the  button. The control panel shows up.
  2. To activate the function touch the symbol.
- To turn off the appliance press the  button again.





## Activating Maximum Motor Speed

When you press the button , the Maximum Motor Speed starts to operate for 6 minutes. After that time, the appliance returns to its previous speed settings.

-  When the function is active, the filter alarm indicator  is turned on (white).
-  When the function is turned on, additional touch on the button  does not have any effects.

## Activating and deactivating the charcoal filter notification:

1. Switch on the control panel.
2. Make sure that the icons are turned off.
3. To activate or deactivate the charcoal filter notification touch the button  for 3 seconds.

-  If the charcoal filter notification is activated, the filter icon  flashes (white) for 5 seconds.
-  If the charcoal filter notification is deactivated, the filter icon  remains fixed (white) for 5 seconds.

## Care and cleaning

### Cleaning the grease filter

Each filter must be cleaned at least once a month. Filters are mounted with the use of clips and pins on the opposite side.

#### To clean the filter:

1. Pull the handle on the filter underneath the hood (1) and slightly tilt the front of the filter down.

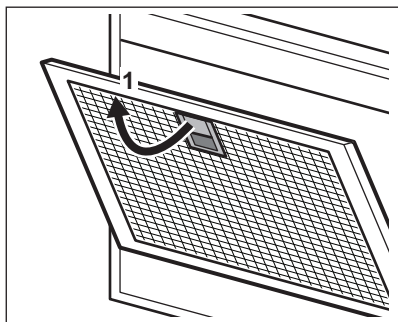

2. Clean the filters using a sponge with non abrasive detergents or in a dishwasher.



The dishwasher must be set to a low temperature and a short cycle. The grease filter may discolour, it has no influence on the performance of the appliance.

3. To mount the filters back follow the first two steps in reverse order. Repeat the steps for all filters if applicable.

## Replacing the charcoal filter



**WARNING!** The charcoal filter is non-washable!

The time of saturation of the charcoal filter varies depending on the type of cooking and the regularity of cleaning the grease filter.

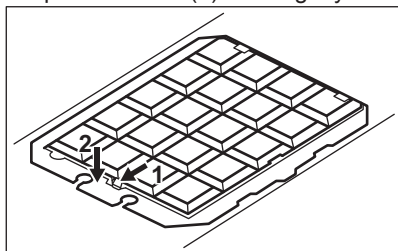

To replace the filter:

1. Remove the grease filters from the appliance. Refer to "Cleaning the grease filter" in this chapter.
2. press the tab (1) and slightly tilt the front of the filter (2).



3. To install a new filter, perform the same steps in reverse order. In any case, it is necessary to replace the filters at least every four months.

## Filter alarm

Filter alarm reminds to change or clean the charcoal filter and clean the grease filter. The filter indicator  is turned on (red) for 30 seconds if the grease filter must be cleaned. The filter indicator  flashes (red) for 30 seconds if the charcoal filter must be replaced or cleaned.

 Refer to cleaning the grease filter in this chapter.

 Refer to cleaning the charcoal filter or replacing the charcoal filter (depends on filter type).

### To reset the alarm:

Touch the  for 3 seconds.



## Replacing the lamp

This appliance is supplied with a LED lamp. This part can be replaced by a technician only. In case of any malfunction refer to "Service" in the "Safety Instructions" chapter.

# Troubleshooting

 **WARNING!** Refer to Safety chapters.

## What to do if...

Problem	Possible cause	Remedy
You cannot activate the appliance.	The appliance is not connected to a power supply or it is connected incorrectly.	Check if the appliance is correctly connected to the electrical supply.
You cannot activate the appliance.	The fuse is blown.	Make sure that the fuse is the cause of the malfunction. If the fuse is blown again and again, contact a qualified electrician.
The lamp does not operate.	The lamp is defective.	Replace the lamp. Refer to the "Care and Cleaning" chapter
The appliance does not absorb enough vapours.	The motor speed is not adequate to the appearing vapours.	Change the speed of the motor.
The filter alarm indicator  is on.	The filter alarm is on. The grease filter must be cleaned.	Refer to the filter alarm in care and cleaning chapter.
The filter alarm indicator  flashes.	The filter alarm is on. The charcoal filter must be replaced or cleaned.	Refer to the filter alarm in care and cleaning chapter.

## Your guarantee

### Product Guarantee Details (UK only)

**Your appliance has the benefit of a comprehensive manufacturer's guarantee which covers the cost of breakdown repairs. (Details of which are shown on your Proof of Purchase Document).**

- Any claim during the period of the guarantee (MUST BE ACCOMPANIED BY THE PROOF OF PURCHASE)
- The product must be correctly installed and operated in accordance with the manufacturer's instructions and used for normal domestic purposes.
- This guarantee does not cover accidental damage, misuse or alternations which are likely to affect the product.
- The guarantee is invalid if the product is tampered with, or repaired by any unauthorised person.

**(The guarantee in no way affects your statutory or legal rights)**



**What to do if you need to report a problem-**

**Please ensure you have ready:**

- **The product's model & serial numbers**
- **Howdens Proof of Purchase document**
- **Your full contact details**

 **Call the Service Line on 0344 460 0006**

## Environmental concerns

Recycle materials with the symbol . Put the packaging in relevant containers to recycle it. Help protect the environment and human health by recycling waste of electrical and electronic appliances. Do not dispose of appliances marked with the symbol  with the household waste. Return the product to your local recycling facility or contact your municipal office.









Product serial number  
(Place sticker here)

**LAMONA**  
Exclusive to Howdens Joinery Co.