

LAMONA

at the heart of the kitchen

50:50 Integrated Fridge Freezer - Frost Free

LAM6252



User Instructions

ISSUE v1.3 091123

Register 
my appliance

www.howdens.com/appliance-registration



Free 3 year guarantee

Call now¹

Within the UK:

0333 010 0009

Within Republic of Ireland:

01525 5752

Alternatively, visit www.howdens.com/appliance-registration

LAMONA

**3 year guarantee available.
Register your appliance within 90 days²**

By registering your appliance and creating an account, we will keep you up to date with the latest product information and notify you immediately of any important product updates

¹Lines are open Monday to Friday 9am to 5pm. Calls will be charged at your local rate and may be recorded and monitored for training and quality purposes.

²So that in the event of an important product update, or recall, we can contact you.

Register 
my appliance

Welcome

Dear Customer

Congratulations on your choice of fridge freezer.

- Please read these instructions before use to ensure safe and economical operation of the fridge freezer.
- Please keep these instructions in a safe place for your future reference.

- If you have any questions, or if you are not sure about any information contained in this booklet please contact us - details at the end of the User Instructions.

This appliance is intended to be used in household and similar domestic applications, see guarantee page for definition of domestic use*.

Throughout this manual the following symbols are used.

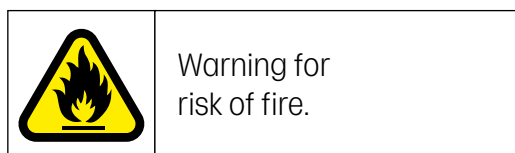
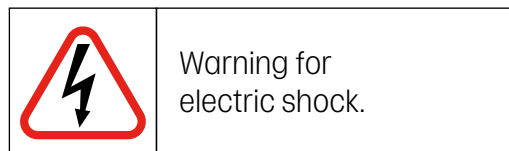
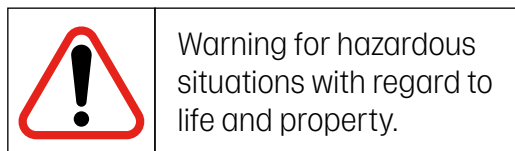

Contents

Register my appliance	p.2	Freezing fresh food	p.11
Welcome	p.3	Door alarm	p.11
Fridge freezer overview	p.4	Noises	p.11
Warning and Safety information		Making ice cubes	p.11
Correct usage	p.5	Defrosting fridge compartment	p.12
Safety with children	p.5	Defrosting freezer compartment	p.12
Warning - general	p.6	Fridge shelf removal/adjustment	p.13
Cooling circuit	p.6	Wine rack adjustment	p.13
Compliance with WEEE Directive and Disposal of the Waste Product	p.6	Salad crisper removal	p.14
Packaging information	p.6	Door shelf removal/adjustment	p.14
Cleaning and care	p.6	Freezer drawer removal	p.14
Disposing of the old appliance	p.6	Freezer glass separator shelf removal	p.14
Electrical connection	p.7		
1 - Upon installation		3 - Cleaning and care	
Before operating the fridge freezer	p.7	Cleaning agents	p.15
Installation instructions	p.7	Prepare the fridge freezer for cleaning	p.16
Replacing the interior light	p.7	Fridge shelf removal	p.16
		Cleaning	p.16
2 - Using the fridge freezer		Fridge interior	p.16
Temperature control and adjustment	p.8	Fridge fittings and freezer drawers	p.16
Cold zones	p.9	Fridge defrost channel	p.16
Storing frozen food	p.9	Cleaning the door seals	p.17
Loading	p.9	Cleaning the ventilation grille	p.17
Food storage and energy efficiency	p.10	After cleaning	p.17
Food storage advice and recommendations to avoid waste food and energy	p.10	4 - Problem solving	p.18
		5 - Guarantee	p.19
		7 - Technical specifications	p.20

Fridge freezer overview

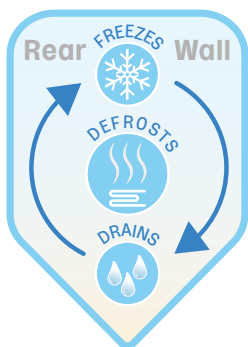

***NOTE:** The rear wall of the fridge section may be wet or frozen. This is the normal cooling cycle process in operation.

Noises - modern energy saving, more environmentally friendly refrigeration appliances generate many and varied noises when working. This is normal.

Warning and Safety information



Please read these instructions. The manufacturer is not responsible if an incorrect installation and use causes injuries and/or damage. Always keep the instructions with the fridge freezer for future reference.

Correct usage

Your **LAMONA** product is designed to be built-in and for domestic household use only, (see guarantee page for definition).

This fridge freezer must only be used for its intended purpose ie: the storing and freezing of edible foodstuffs.

The appliance is not suitable for storing and keeping cool: medicines, blood plasma or laboratory preparations. Used for such a purpose can cause deterioration of the items stored.

The appliance is designed for use within a certain climate range. Installing it in a room with too low an ambient temperature, eg. a garage, may lead to the appliance switching off for long periods so that it cannot maintain the required temperature.



WARNING: Do not damage the refrigerant circuit.

Do not store explosive materials in the appliance or any products containing propellants, eg. spray cans, Electrical components could cause flammable vapours to ignite. Danger of fire and explosion.

WARNING: Do not cover or block air vents as this will impair the efficiency of the appliance and increase the electricity consumption.

Do not operate any electrical equipment, eg. an electric ice cream maker, inside the appliance.

Do not store cans or bottles containing carbonated drinks or liquids that could freeze in the freezer.

When cooling drinks quickly in the freezer, make sure bottles are not left in for more than an hour, otherwise they could burst causing injury or damage to the appliance.

Do not handle frozen food or the metal parts of the appliance with wet hands. Your hands may freeze to the frozen food or to the metal. Danger of frost burns.

Do not take ice cubes out with your bare hands and never place ice cubes or ice lollies in your mouth straight from the freezer. Danger of frost burns to the lips or tongue.

If freezing to a frozen surface occurs:

- **Do not** tear away!
 - Use cold water to release
- First Aid, (if necessary).
 - Hold affected area under cold running water.

Do not refreeze partially or fully defrosted food. Consume defrosted food as soon as possible as it will lose its nutritional value and spoil if left for too long. Defrosted food may only be re-frozen after it has been cooked.

Follow the manufacturer's 'Use By' dates and storage instructions given on food packaging to avoid the risk of food poisoning.

This appliance is not intended for use by persons (including children) with reduced physical, sensory or mental capabilities, or lack of experience and knowledge, unless they have been given supervision and instruction concerning the correct use of the appliance (as per this manual), by a person responsible for their safety.

To avoid a hazard due to instability of the appliance, it must be fixed in accordance with the installation instructions.

Installation, maintenance and repairs must only be carried out by a suitably qualified person.

Whilst the appliance is under warranty, repairs must only be made by a **LAMONA** authorised service technician. Failure to do this will invalidate the warranty.

Safety with children

- Children under 8 years of age must be kept away from the appliance unless they are constantly supervised.
- Children 8 years and older may only use the appliance unsupervised if they have been shown how to use it in a safe way and recognise and understand the consequences of incorrect operation.
- Children must not be allowed to clean or maintain the appliance unsupervised.

- Please supervise children in the vicinity of the appliance and **do not** let them play with the appliance.
- Danger of suffocation! Whilst playing, children could become entangled in packaging (such as plastic wrapping) or pull it over their head and suffocate. Keep packaging material away from children.

Warning - general

- **Do not** use any sharp objects inside the product, eg. to defrost.
- **Do not** use a damaged appliance, it could be dangerous.
- Ensure the mains plug remains accessible.
- The appliance must not be used in a non-stationary location, eg. on a ship.



Cooling circuit

The cooling circuit is factory tested for leaks. This appliance complies with statutory safety requirements and the relevant Standards.

This appliance contains coolant Isobutane (R600a) which is less environmentally damaging, although it is flammable.

The use of this coolant has led to a slight increase in the noise level of the appliance. Additionally you might be able to hear the coolant flowing through the system. This does not have any adverse effects on the performance of the appliance.



WARNING: If cooling circuit is damaged;

- Leaking coolant can damage the eyes
- Avoid naked flames or anything that creates a spark.
- Disconnect the appliance from the mains electricity supply if damage is caused to the cooling system.
- Ventilate the room.
- The more coolant there is in an appliance the larger the room it should be installed in. In the event of a leakage, if the appliance is in a small room, there is danger of a combustible gas build up. The amount

of coolant is stated on the data plate inside the appliance. For every 11g of coolant at least 1m³ of room space is required.

Compliance with WEEE Directive and Disposal of the Waste Product

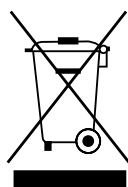

This product bears classification symbol for waste electrical and electronic equipment (WEEE). This product has been manufactured with high quality parts and materials which can be reused and are suitable for recycling. **Do not** dispose of the waste product with normal domestic and other wastes at the end of its service life. Take it to the collection centre for the recycling of electrical and electronic equipment. Please consult your local authorities to learn about these collection centres.

This appliance complies with all relevant safety standards.

Package information

Danger of suffocation keep packaging material away from children.

Cleaning and care

- **Do not** use any oils or grease on the door seals, as this will cause the seals to deteriorate and become porous.
- **Do not** use steam cleaning equipment to clean or defrost the appliance. Steam could reach electrical components and cause a short circuit.
- **Do not** place electric heaters or candles in the appliance to defrost it. These will damage the plastic parts of the fridge freezer.
- **Do not** use defrosting sprays or de-icers, as they could contain substances which could damage the plastic parts or might cause a build-up of gases and pose a danger to health.

Disposing of the old appliance

Please dispose of the old appliance without harming the environment.

- Remove the electric plug.
- If there are locks on the door, make them inoperable. In this way you will prevent children from accidentally locking themselves in and endangering lives.

- Please contact the local council about the disposal or waste collection.
- Be careful not to damage any part of the coolant system whilst awaiting disposal, eg.
 - puncturing the coolant channels in the condenser.
 - bending any pipework.
- Splashes of coolant can damage the eyes.
- The oil in the compressor can be fatal if swallowed or inhaled.

Electrical connection

- The appliance is supplied with a power cable and moulded plug ready for connection to a 220 - 240v AC 50 Hz supply.
- The fuse rating should be 13 A.
- This appliance must be earthed.
- This appliance must be connected to a suitable switched socket which is always easily accessible.
- The electrical connection must comply with current local and national safety regulations (BS 7671 in the UK).
- The plug and mains cable must not come into contact with the back of the appliance. Vibrations can damage them; which could result in a short circuit.
- **Do not** connect the appliance to the mains electricity by an extension lead or multi-adapter.
- The appliance must not be used with energy-saving plug devices. The appliance will not function correctly and may overheat.
- If the mains cable or plug needs to be replaced this must be done by a suitably qualified person.
- Check that the appliance is working correctly.

1 - Upon installation

 Please remember that the manufacturer shall not be held liable if the information given in this manual is not observed.

Before operating the fridge freezer

- Remove all packaging material from the inside of the appliance.
- Clean the interior and the accessories as recommended, see cleaning and care section.
- You may hear various noises coming from the cooling system and when the compressor starts. This is normal.
- Set the temperature control to the desired temperature.
- Front edges of the fridge freezer may feel warm, this is quite normal. (Designed to avoid condensation)
- **Do not** load the appliance immediately after switching on. Wait a 6 hours until the correct storage temperature is reached. We recommend that you check the temperature with an accurate thermometer.
- Check the appliance is working correctly.

Installation instructions

- The room where the appliance is installed must not be smaller than 10 cubic metres.
- See detailed '**Installation Instructions**', including reversing door opening direction.
- This refrigerating appliance is intended to be used at ambient temperatures ranging from **+10°C** to **+38°C** (SN-ST). If the ambient temperature drops too low the appliance will not function correctly
- Do not place the appliance in direct sunlight as this may cause the appliance to work less efficiently

Replacing the interior light

The LED lamp is not replaceable by the user.

If a failure occurs please call **LAMONA** Service Line.

The light is intended only to illuminate the fridge section to assist safe food handling.

2 - Using the fridge freezer

Switch ON

Press and hold for 3 seconds



Fridge and freezer temperature control

Initial temperature setting
(Recommended)



Setting 1 - Warmer



Setting 3 - Colder



Setting 4 - Maximum cold



Quick freeze

Continuous Cooling.
(Will deactivate after 25hrs
if not stopped)



Alarm off

Alarm sounds after 1 minute
with door open



Fault Alert

Press 'Alarm Off' to clear fault display.
(If fault returns note display and call LAMONA service)



Switch OFF

Press and hold for 3 seconds



Cold zones;

- Due to natural air circulation there are different temperature zones in the fridge section.
- Cold, heavy air falls to the lower sections of the appliance.
- The coldest area in the fridge is directly above the fruit and vegetable drawer and at the back of the appliance. (Food must not touch the back of the fridge section as it may freeze to the back wall)
- The warmest area is at the top, in the frontal area and in the door sections. Use these areas for storing butter, cheese etc.

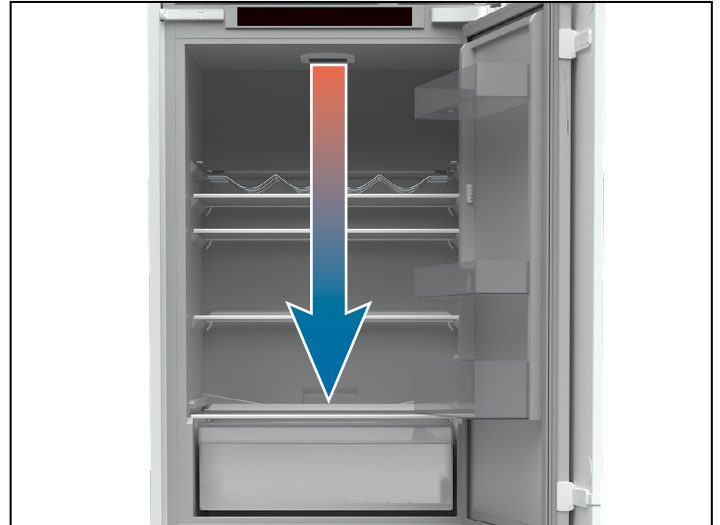

Storing frozen food

Pre-packed commercially frozen food should be stored in accordance with the frozen food manufacturer's instructions for a ******** frozen food storage compartment. If possible try to leave air circulation channels through stored food.

If there is a power failure **do not** open the freezer door. Frozen food should not be affected if the failure lasts for a few hours. (See rating plate inside fridge section for actual food conservation time). If the failure is longer, then the food should be checked and either eaten immediately or cooked then re-frozen.

The freezer pack will help maintain the cold temperature in the freezer.

If the freezer pack is damaged it should be safely disposed of. (The liquid is not suitable for drinking).

DO NOT lift and carry drawer by the drawer front -
Use side handles to carry.



Loading;

- Allow air to circulate efficiently, **do not** pack food too closely together in the fridge and freezer sections.

The normal storage temperature of the fridge should be no higher than **+5°C (+41°F)** - centre shelf.

The normal storage temperature of the freezer should be no less than **-18°C (0°F)**.

We recommend that you check the temperature with an accurate thermometer to ensure that the storage compartments are kept to the recommended temperature to ensure safe food storage and energy efficiency.

We recommend that food is always covered and not to store open containers or foodstuffs.

Please remember; each time the door is opened cold air escapes and the internal temperature rises.

Therefore never leave the door open and always close it immediately after food is put in or removed.

If ice builds up on the fridge rear wall and doesn't appear to defrost as normal:

Select the initial temperature setting for a short period of time until the ice melts.

Food storage and energy efficiency

The most efficient use of energy is ensured in the configuration of the drawers and shelves in their default positions, with foodstuffs evenly distributed throughout.

- Place raw meat and fish on the coolest, lowest shelf where they cannot drip onto other foods. Butter and cheese can be placed in the door racks or on the upper shelves where the temperature is not as cold. Incorrect storage can promote bacterial growth, shorten storage life and increase waste.
- Ensure the time between buying chilled/frozen food and placing them in the appliance is kept to a minimum, particularly in summer. We recommend you use a cool bag to carry frozen food.
- **Do not** leave the door(s) of the appliance open longer than is necessary and ensure they are closed properly after each opening.
- Defrost frozen food in the fridge compartment, so that the frozen food acts to assist cooling the fridge.

Food storage advice and recommendations to avoid waste food and energy

Do - Clean the fridge freezer regularly, see cleaning and care.

Do - Store raw meat and poultry below cooked food and dairy products.

Do - Take off any unusable leaves from vegetables and wipe off any soil.

Do - Leave lettuce, cabbage, parsley and cauliflower on the stem.

Do - Wrap cheese firstly in greaseproof paper and then in a polythene bag excluding as much air as possible. For best results take out of the fridge compartment an hour before eating.

Do - Wrap raw meat and poultry loosely in polythene or aluminium foil. This prevents drying.

Do - Wrap fish and offal in polythene bags.

Do - Wrap foods which have a strong odour or can dry out in polythene bags, aluminium foil or place in an airtight container.

Do - Wrap bread well to keep fresh.

Do - Chill white wine, beer, lager, and mineral water before serving.

Do - Check the contents of the freezer.

Do - Keep food for as short a time as possible and adhere to 'Best Before', 'Use By', dates.

Do - Store commercially frozen food in accordance with the instructions given on the packets.

Do - Always choose high quality fresh food and be sure it is thoroughly clean before freezing it.

Do - Prepare fresh food for freezing in small portions to ensure rapid freezing.

Do - Wrap all food in aluminium foil or freezer quality polythene bags and make sure any air is expelled.

Do - Wrap frozen food when you buy it and put it in to the freezer as soon as possible.

Do - Defrost food in the fridge compartment.

Don't - Store bananas in the fridge compartment.

Don't - Store melon in the fridge. It can be chilled for short periods as long as it is wrapped to avoid it flavouring other foods.

Don't - Store poisonous or any dangerous substances in the fridge freezer. It has been designed for the storage of edible foodstuffs only.

Don't - Consume food which has been stored for an excessive time in the fridge.

Don't - Store cooked and fresh food together in the same container. They should be packaged and stored separately.

Don't - Let defrosted food or food juices drip onto other food.

Don't - Leave the door open for long periods as this will make the appliance more costly to run and cause excessive ice build-up.

Don't - Put hot food into the appliance. Let it cool down first.

Don't - Store liquid filled bottles or sealed cans containing carbonated liquids into the freezer as they will burst.

Don't - Exceed the maximum freezing loads when freezing fresh food.

Don't - Give children ice-cream and water ices direct from the freezer. The low temperatures may cause 'freezer burns' on lips.

Don't - Try to keep frozen food which has thawed, it should be eaten within 24 hours or cooked and refrozen.

Don't - Remove items from the freezer with wet hands.

Don't - Close the freezer door before closing the freezer drawers.

Don't - Leave frozen food at room temperature to thaw; the best way to defrost is to put it in the fridge to thaw slowly. Make sure to avoid defrosting food or food juices dripping onto other food.

Freezing fresh food

Please observe the following instructions to obtain the best results.

Do not freeze very large quantities at any one time. The quality of the food is best preserved when frozen to the core as quickly as possible.

Do not place warm food into the freezer. The fridge section may over cool.

If freezing large quantities of fresh food select the **'Quick freeze'** temperature setting for a few hours, then de-select to return to normal setting. (Up to **0.5 kg** of food can be frozen without changing the temperature setting)

You may place fresh food to be frozen in any part of the freezer.



Door alarm

An alarm will sound if the fridge/freezer door is left open for more than 1 minute.

- Select **'Alarm Off'** on the controls to stop the alarm.

Noises

During the normal operation of the freezer several different types of noises may be heard including; 'cracks', 'gurgles' and fan 'humming'. **This is normal.**



Compressor or fan	Starting or ending an operation	Expanding materials	Coolant circulating in the system	
Whirr / SSRR	Buzz	Click / Crack	Shsss / Hiss	Gurgle/Glug

Making ice cubes

- Fill the ice cube tray 3/4 full with water and place in the bottom of one of the freezer drawers or on the freezer tray.
- If necessary, use a blunt instrument, eg. a spoon handle to remove the ice tray from the freezer if it is stuck.
- Ice cubes can be removed easily by twisting the tray gently or by holding it under cold running water.

Suggestion: Place ice cubes into a freezer bag for long term storage.

Defrosting fridge compartment

The fridge compartment defrosts automatically.

The defrost water runs to the drain tube via the collection channel at the back of the fridge, see image. During defrosting water droplets form at the back of the fridge where the concealed evaporator is located. Some droplets may remain on the liner and refreeze when defrosting is completed. **Do not** use pointed or sharp edged objects such as knives, forks etc. to remove the droplets which have frozen.

If at any time the defrosted water does not drain from the collection channel, check to see if the drain channel has an obstruction. The drain tube can be cleared by pushing the special plastic plunger, provided, down the drain tube, see image. If there is an ice build up, select the first temperature setting for a few hours until the ice melts.

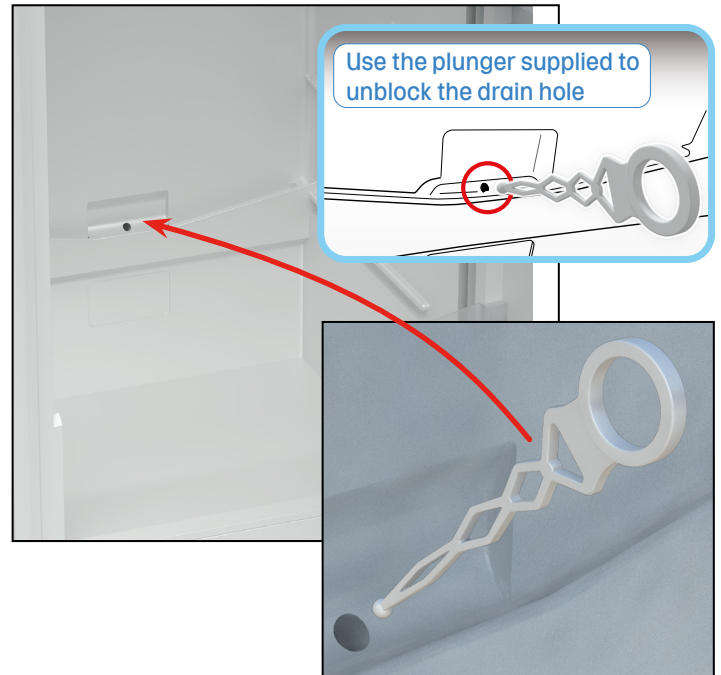

Defrosting freezer compartment

The freezer compartment defrosts automatically.

WARNING: The fan inside the freezer compartment circulates cold air. Never insert any object through the guard.

- Leave spaces in and around the food so that air can circulate.
- Ice may build if the freezer drawers are packed tightly.
- The glass shelves may be removed to allow storage of larger items.

 **Caution:** Glass, handle carefully.



Fridge shelf removal/adjustment

The shelves can be adjusted according to food storage requirements.
Only remove/adjust the shelves when they are empty.

- Lift the front edge of the shelf and pull forwards.
- Insert shelf at the desired height.

The raised edge on the protective strip at the back must face upwards to prevent food touching the back of the fridge and freezing to it.

Do not let foodstuffs contact the rear wall. Ice will form across and lead to water deposits on shelves and in the fridge.

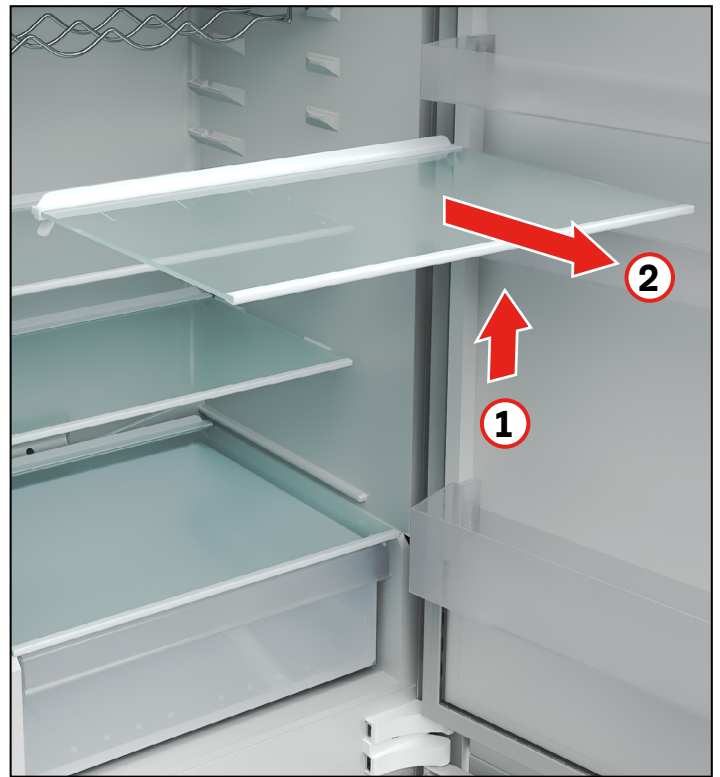

Wine rack adjustment

- Lift the wine rack at the front edge, **1** and move forwards, **2** to disengage the rear lug.
- Insert the wine rack at the required height. Ensure that it is securely pushed back into place.

To set at an angle.

- Lift the wine rack at the front edge, **1** and move forwards, **2** to disengage the rear lug, **3**.
- Insert the wine rack at the required height placing the rear lug on the shelf height below. Ensure that it is securely pushed back into place.

Do not let large / heavy bottles drop into the wine rack.

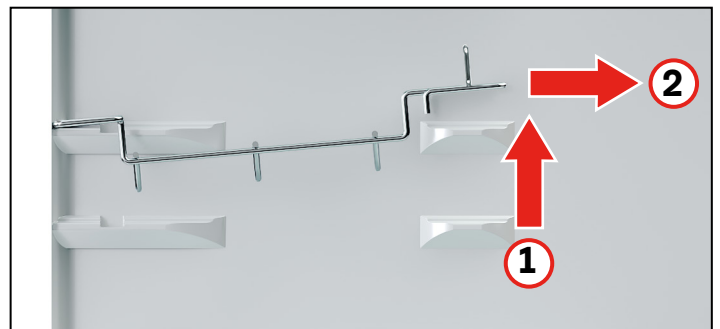

Salad crisper removal

The salad crisper can be removed for cleaning.

- Open the drawer to its maximum, lift upwards and remove.

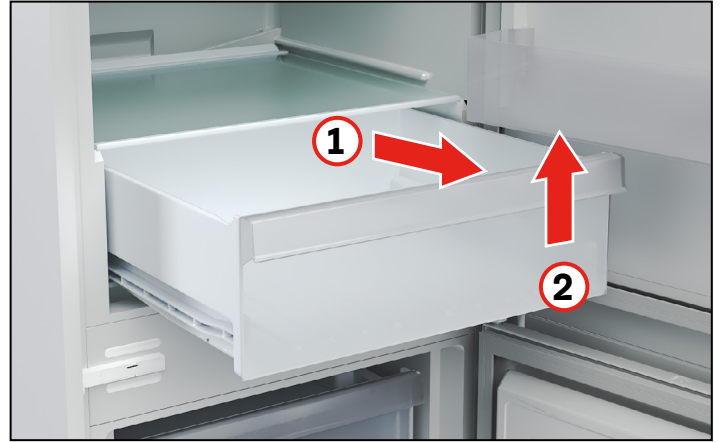

Door shelf removal/adjustment

Only remove the door/bottle shelves when they are empty.

- Gently push the door shelf upwards from underneath.
- Replace the shelf at the required height. Ensure that it is securely fixed.

Do not let large / heavy bottles drop into the door shelf.

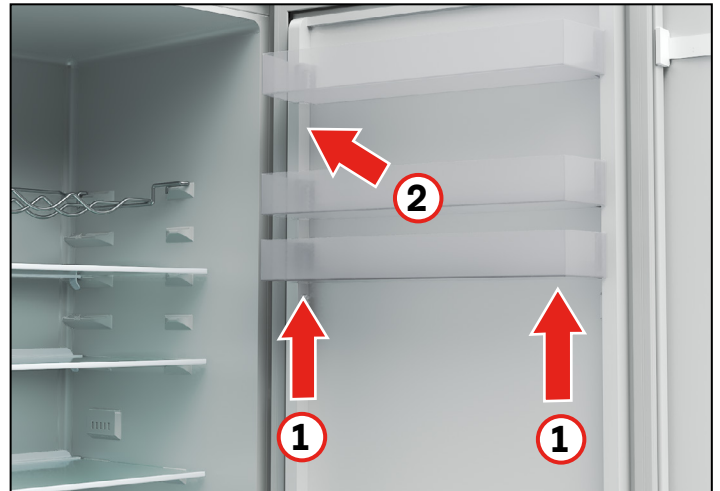

Freezer drawer removal

To remove a freezer drawer.

- Pull forwards as far as possible.
- Grab drawer by handles and lift away.

! **DO NOT** lift and carry drawer by the drawer front
- Use side handles to carry.

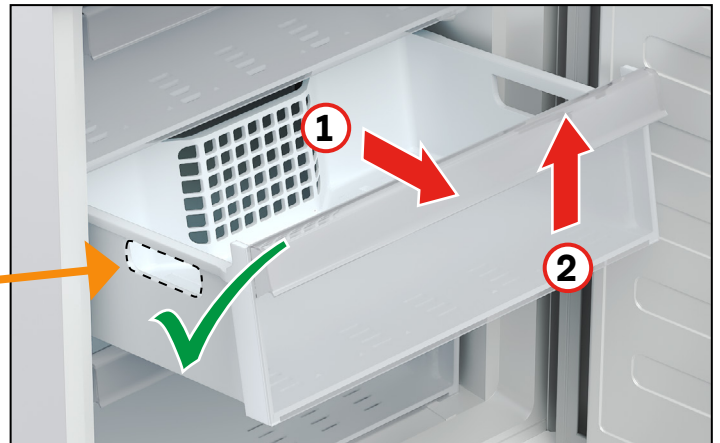

Freezer glass separator shelf removal

The glass shelves may be removed to allow storage of larger items.

! **Caution:** Glass, handle carefully.

- Remove the freezer drawer(s).
- Lift the front edge of the glass separator shelf and remove.

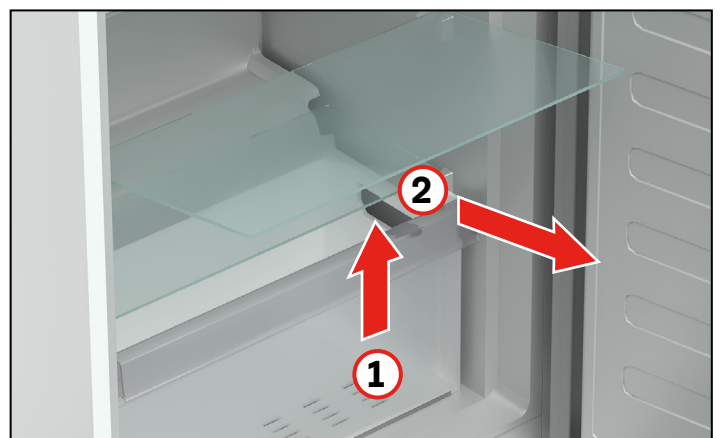

3 - Cleaning and care

 We recommend that you switch off the fridge freezer at the mains socket and remove the plug from the mains socket before any cleaning or maintenance.

 **Do not** let any water penetrate any part of the appliance electrics or lighting.

 Cleaning water must not drain into the defrost drain hole.

 If the fridge freezer is not going to be used for a long period of time switch it off, remove all food, clean and leave the door ajar.

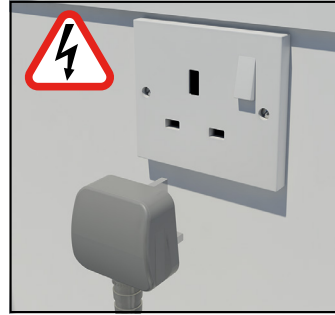

The data plate located inside the fridge freezer must not be removed. It contains information which is required if you need to call a service engineer.

Cleaning agents

We recommend using a clean cloth or sponge and lukewarm water with a small amount of washing-up liquid added to clean the surfaces.

All cleaning agents used inside the appliance **must** be food safe.

To avoid damage to surfaces of the fridge freezer, **do not use** the following:

- Cleaning agents containing soda, ammonia, acids or chlorides.
- Cleaning agents containing de-scaling agents.
- Abrasive cleaning agents, eg. powder or cream cleaners.
- Solvent based cleaning agents.
- Stainless steel cleaning agents.
- Dishwasher cleaning agents.
- Oven sprays.
- Glass cleaning sprays.
- Hard, abrasive sponges and brushes, eg. scourers.
- Melamine eraser blocks.
- Sharp metal scrapers.

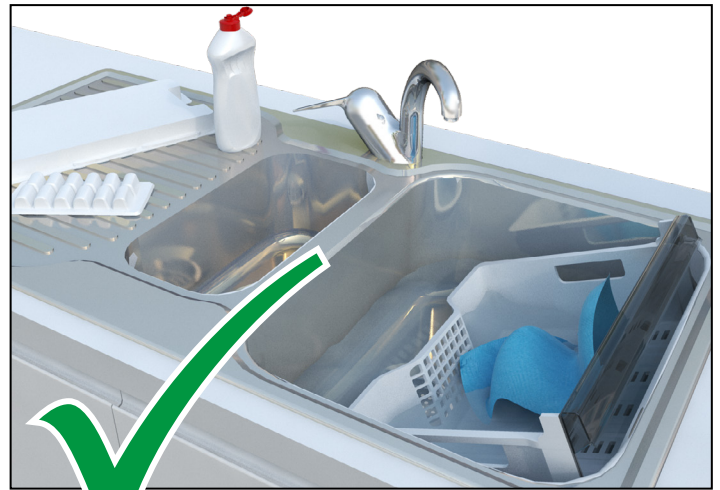

Prepare the fridge freezer for cleaning

 Switch off the fridge freezer at the mains socket and remove the plug.

If the interior light is still on when you open the fridge door the appliance is still connected to the mains electric.

- Remove any food and store in a cool place.
- Remove the glass shelves and door shelves.
- Remove the freezer drawers.

WARNING: Fridge glass shelves;

- Remove and place the glass shelves on a worktop that is covered with a towel.
- Remove the front trims only from the glass shelves and clean. **Do not** use abrasive pads, scourers.
- After cleaning, replace the front trims.



Cleaning

Clean the fridge interior monthly.

Clean the freezer compartment annually.

Remove any spillages immediately to prevent them from drying onto the surfaces.

Fridge interior;

- Clean the interior with a clean cloth or sponge and lukewarm water with a small amount of washing-up liquid added.
- After cleaning, wipe over and dry using a soft cloth.
- Leave the doors open to air the fridge and prevent any odour build up.

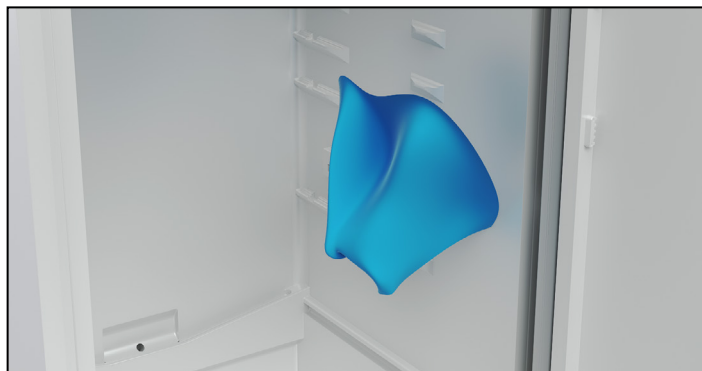

Fridge fittings and freezer drawers;

Do not use a dishwasher to clean.

- Clean the fridge fittings and freezer drawers with a clean cloth or sponge and lukewarm water with a small amount of washing-up liquid added. (Bicarbonate of soda may be added to the water to remove odours if necessary).
- After cleaning, wipe over and dry using a soft cloth.



Fridge defrost channel;

- Wipe the defrost collection channel and drain hole frequently. Use the special plastic plunger provided to clear any blockages.

Do not pour any water down the hole.

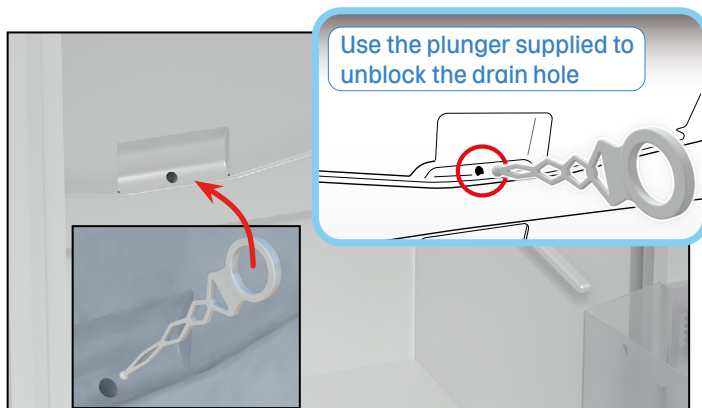

Cleaning the door seals

Do not use any oils or grease on the door seals, as this will cause the seals to deteriorate and become porous.

- The door seal should be cleaned regularly using a mild detergent and clean cloth. Wipe dry using a clean cloth.
- If required the door seal can be removed for an extra deep clean.
- **Take extreme care not to damage the door seal(s) when removing and replacing them.**

To remove:

Starting at a corner gently peel away the seal from the channel, working away along the door.

To replace:

Starting at a corner, press in the seal working away and along the door, pressing the seal into the channel.



Cleaning the ventilation grille

A build-up of dust within the ventilation areas will increase the energy consumption of the fridge freezer.

- The ventilation area should be cleaned regularly using a soft brush and vacuum cleaner.

After cleaning

- Replace all the shelves and accessories.
- Reconnect to the mains socket and switch on.
- Place the food in the fridge section and close the door.
- Once the freezer temperature has returned to the required temperature, below 0°C, place the food back in the freezer drawers.



4 - Problem solving

If the appliance does not operate when switched on, check that:

- The plug is inserted properly into the mains socket and that the power supply is on. (To check the power supply to the mains socket, plug in another electrical appliance).
- The fuse has blown/circuit breaker has tripped/ main distribution switch has been turned off.
- The temperature control has been set correctly.
- Rear wall of the fridge is wet - this is normal, it freezes and then de-frosts.
- New plug is wired correctly if you have changed the fitted moulded plug.
- Too much ice developing:
 - Door not closed properly or open for long period of time.
 - Freezer drawers not full enough.
 - Warm food being placed in fridge freezer.

- Vibration noise:
 - Bottles/jars in fridge making contact with each other or touching the walls of fridge freezer.
- Water at bottom of fridge
 - Rear collection channel overflowing due to blockage by item.
 - Use plastic plunger to unblock.
- Water on shelf:
 - Stored item touching rear wall.

If the appliance is still not operating after the checks, then call **LAMONA** Service Line.

Please ensure that the checks have been made as a charge may be made if no fault is found.

5 - Guarantee

Product Guarantee Details (UK & Republic of Ireland only)

Your appliance has the benefit of a comprehensive manufacturer's guarantee which covers the cost of breakdown repairs. (Details of which are shown on your Proof of Purchase Document).

- Any claim during the period of the guarantee **MUST BE ACCOMPANIED BY THE PROOF OF PURCHASE.**
- The product must be correctly installed and operated in accordance with the manufacturer's instructions and used for normal domestic purposes.
- This guarantee does not cover accidental damage, misuse or alterations which are likely to affect the product.
- The guarantee is invalid if the product is tampered with, or repaired by any unauthorised person.
(The guarantee in no way affects your statutory or legal right)

What to do if you need to report a problem.

Please ensure you have ready:

- The product's model and serial numbers.
- Howdens Proof of Purchase Document.
- Your full contact details.

Call the Depot number on your Proof of Purchase Document supplied with the product/kitchen.

or

Call the LAMONA Service Line on:

Within UK 0344 460 0006

Within Republic of Ireland 01525 5703

* Product installed within a domestic kitchen or a non-domestic kitchen where 8 or fewer people are using the appliance.

Spare parts availability - 10 years

Only fit Genuine Spare Parts

www.lamonaspares.co.uk (UK only)

Where to find the model and serial number on the appliance.	On the left-hand, inside surface of the appliance.
---	--

6 - Technical specifications

Specifications

For electrical household fridge freezers,
(Complying with requirements of Regulation EU 2016/2019 and EU 2019/2019).

Brand	LAMONA
Model	LAM6252
Fridge compartment net volume.....	163 Litres
Freezer compartment net volume	91 Litres
Frost free.....	Yes
Freezing capacity (24 hours).....	4.2 kg
Temperature rise time	13 Hrs
Climate class	SN-ST
Noise	38 dbA
Installation	Built in
Voltage.....	220 - 240 V
Frequency	50 Hz
Wattage	125 W
Current.....	0.8 A
Refrigerant type.....	R600a
Refrigerant charge.....	50 g
Fire resistant backing	Yes
Fuse rating in plug	13 A

References of standards and reproducible methods applied for measuring performance; Household refrigeration appliances; IEC 62552-1,-2,-3:2020; EU-Regulations 2016/2019 and 2019/2019, EN60704-2-14:2019.

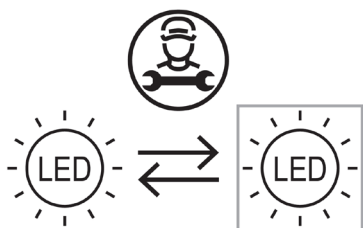

This product contains a light source of energy efficiency class G.

Information

The model's technical information can be retrieved by scanning the QR code on the Energy label and proceeding to the website entering the model identifier.

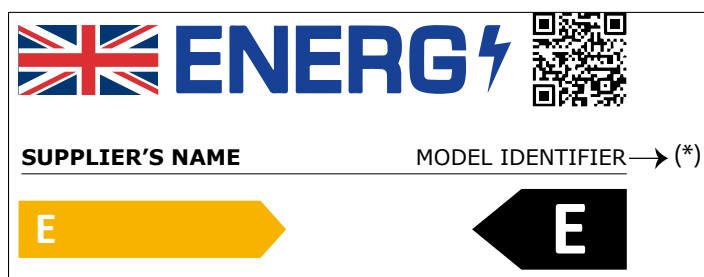
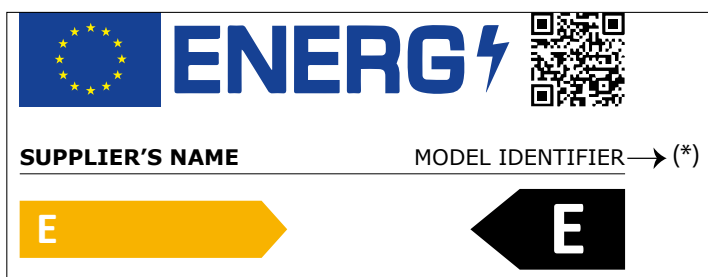



Product serial number
(Place sticker here)

LAMONA



Product information correct at the time of publication in November 2023.
The company has a policy of continuous product development and reserves the right to change any products and specifications given in this manual. Subject to the Terms and Conditions of Trading, a copy of the Howdens Terms and Conditions is available upon request.
Copyright © 2023 Howden Joinery Ltd. All rights reserved.

Howden Joinery Ltd.
Thorpe Road, Howden, East Yorkshire. DN14 7PA England
Howdens Cuisines SAS. Z.A. du Bois Rigault Nord,
1 Rue Calmette, 62880 Vendin-le-Vieil, Cedex, France