

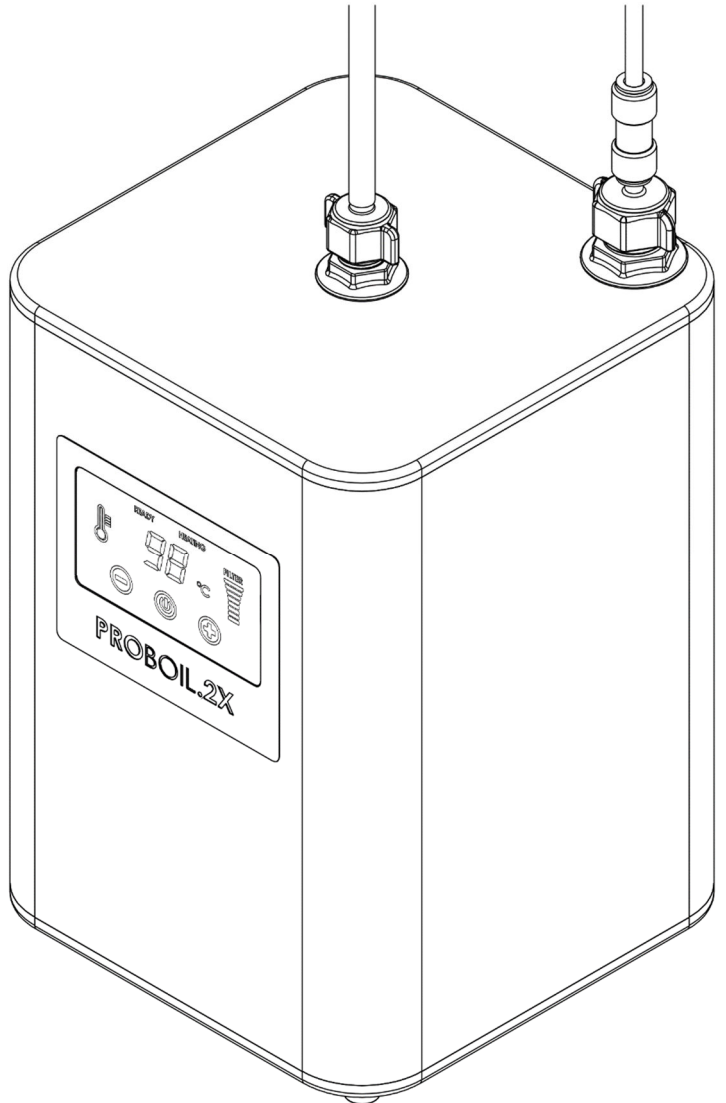

PROBOIL2 to PROBOIL.2X

Upgrade Installation Guide



www.proboil.co.uk

See top of boiler unit for contact details

i Please read these instructions carefully before installation



We have a policy of continued product and quality development and improvement. Accordingly, we reserve the right to amend the specification at any time. All errors and omissions excepted.

Thank you for choosing PROBOIL.2X. By reading this entire guide you will ensure that the product is installed and used safely and will give its best performance, this guide should be used in conjunction with any additional product guides.

1 PROBOIL.2X user guide

1.1 Important safety and usage considerations:

Throughout this guide, the following symbols are used to highlight key points or safety considerations.

 An information point or tip for installation or usage.	 A service, maintenance or care consideration.	 A technical or safety consideration or warning of hazardous situation with regard to life and property.
--	---	---

1.1.1 General safety:

 **WARNING:** this guide is intended solely as explanation for the method to exchange proboil2x boilers like for like, if any modifications are to be made please refer to the complete user and installer guide supplied originally with the product.

 **WARNING:** All surfaces, especially those made from metal, may become hot whilst in operation. Use caution when touching these surfaces. Inform all users that the surfaces may become hot.

 **WARNING:** Do not disconnect the tank until the tank has cooled to a safe temperature.

 **WARNING:** This appliance must be installed respecting local plumbing and electrical regulations.

 **WARNING:** This appliance must use only genuine parts and accessories and sundry consumables.

 **WARNING:** Packaging materials can be dangerous to children and animals; ensure they are disposed of safely and correctly according to local laws.

1.1.2 Electrical safety:

 **WARNING:** Do not use this appliance if you suspect it or any of its cables or hoses are damaged or kinked in any way, or is performing differently from how you would expect. Never use any appliance with a damaged mains power lead. In the event of any suspected problem you should immediately cease usage, isolate the water supply, disconnect the power and contact the service agent noted on the top of the boiler.

 **WARNING:** This appliance must be disconnected from the power during installation, maintenance or cleaning.

 **WARNING:** Only use the supplied power cable and connect it directly to the power outlet rather than an extension power outlet.

 **WARNING:** The appliance must be installed so that it can be disconnected from the mains power supply and the outlet socket must be accessible at all time.

 **WARNING:** This appliance must be connected to a grounded / earthed power outlet only.

 **WARNING:** This appliance must be installed respecting local plumbing and electrical regulations.

 **WARNING:** Do not place any water connections directly near or above electrical appliances or connections.

 **WARNING:** This appliance is not intended to be operated by means of an external time or separate remote control system.

1.1.3 Intended purpose:

 This appliance is intended only for domestic use and should not be used for commercial purposes.

 Do not add to, exchange or modify any component of the boiler, mixer tap, filter or connections from those supplied and install them only as instructed. The spout exit or any part of the system must not include any additional third party adaptors or connections that will add resistance to the system.

 This appliance is intended to be permanently connected to the water mains.

 The boiler and mixer tap are not designed to work with any other combination of appliances other than as shown within this guide.

1.1.4 Sensible fire safety precautions:

 Do not store or use petrol or other flammable rags, paper, aerosols, vapours or liquids in the vicinity of this or any other appliance.

 Install the unit on a heat-resistant surface. Make sure that the installation surface is firm and level.

 For safety regulations the plug or means of disconnection must always be accessible after installation.



 Do not use any water jet or steam near this appliance.

 Always ensure an airgap of at least 10mm around the appliance and that any closed cabinet has sufficient airflow.

2.1 Installation:

2.1.1 Installation preparation

Throughout this guide, the following symbols are used to highlight key points or safety considerations.

 An information point or tip for installation or usage.	 A service, maintenance or care consideration.	 A technical or safety consideration or warning of hazardous situation with regard to life and property.
--	---	---

 **Preparing yourself to install your replacement PROBOIL2X boiler is simple and ensures the process is both quick and safe. The process is very similar to the descaling and cleaning maintenance process in your user guide and requires no specialist tools or knowledge other than this guide.**

 **Before installing your replacement boiler please unpack it and check for any missing parts or transport damage, in case of an issue please contact the service number on top of the boiler.**

 **Whilst installing your replacement boiler please check if the filter is also due to be replaced.**

 **You might find it helpful to photograph the installation before your remove the old boiler as a memory aid.**

This drawing of PROBOIL2 can be used for reference throughout the PROBOIL2X replacement process:

Key	Description	Qty
A1	Mixer tap	1
A2	Base plinth	1
A3	Base plinth seal	1
A4	Sink or worktop (max. 50mm)	
A5	White triangular plate (for steel sinks only)	1
A6	Lower gasket	1
A7	Metal horseshoe	1
A8	Fixing stud	1
A9	Fixing nut	1
B1	Domestic cold flexible hose (including non-return valve)	1
B2	15mm olive	
B3	15mm nut	
B4	15mm pipe	
B5	15mm isolation valve	
B6	Domestic hot flexible hose (excluding non-return valve)	
C1	Cold out (to filter & boiler) flexible hose (including seal)	1
C2	3/8" M x 1/4" F adaptor	1
C3	1/4" NPT M x 1/4" pushfit	1
C4	1/4" outside diameter plastic pipe	1*
C5	Filter bracket screw	1
C6	Filter bracket	1
C7	Filter cartridge	1
D1	110° rated hot water hose (from boiler output)	1
D2	3/8" fibre seal	1
E1	Boiler	1*
E2	Flexible black rubber water output pipe	1*
E3	Connecting tundish assembly	1*
E4	Flexible drain pipe	1*

*Part supplied with boiler pack.

⚠ Do not switch on the boiler until instructed.

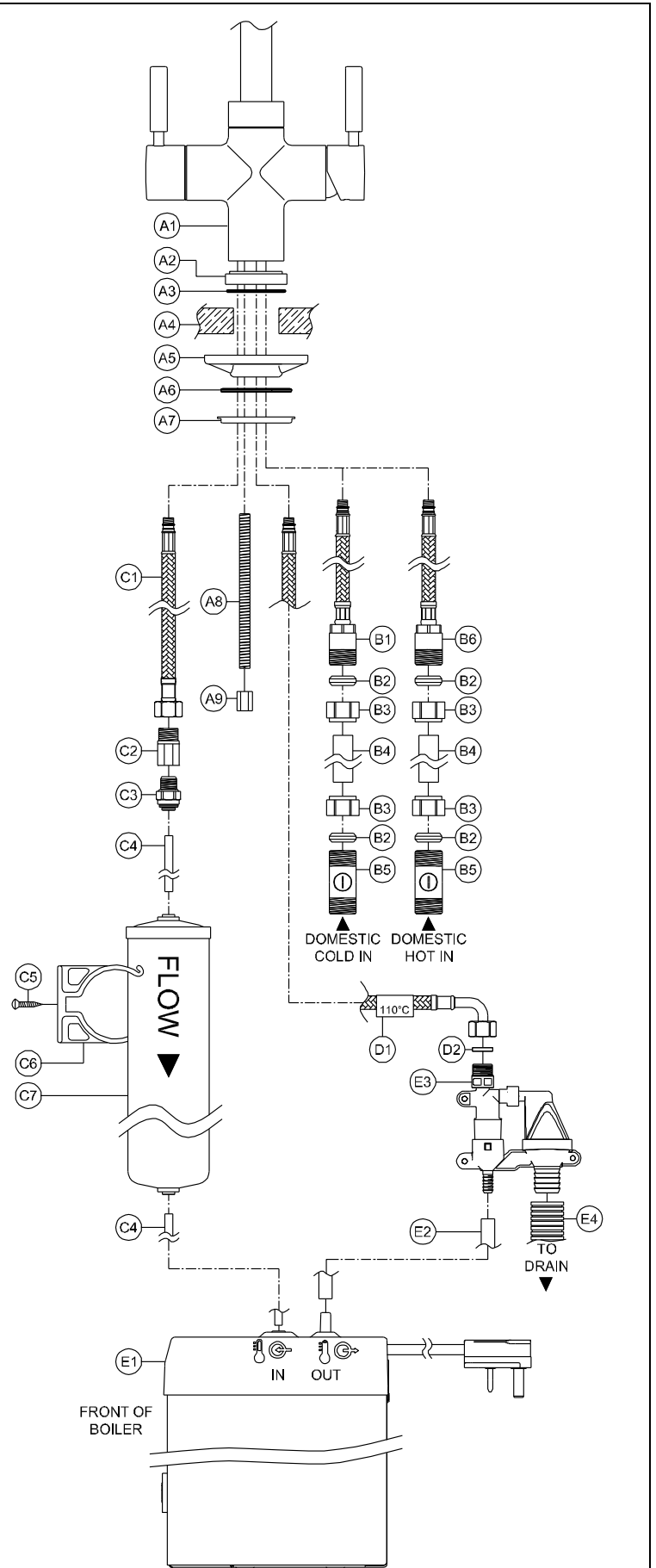

2.1.2 Removing the existing PROBOIL2 boiler:

Remove the boiler:

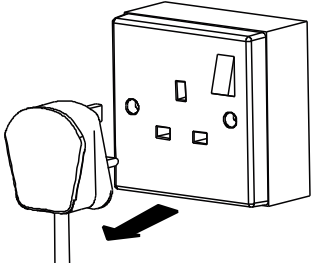
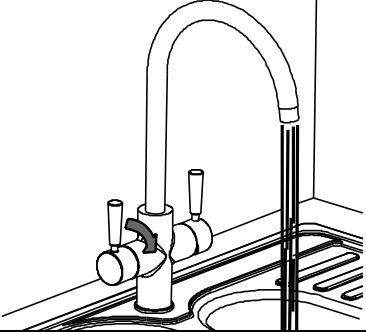
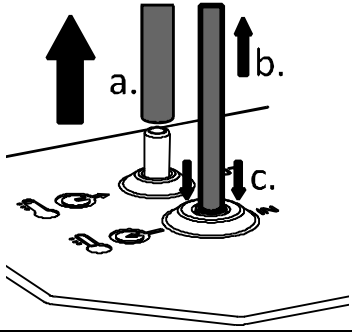
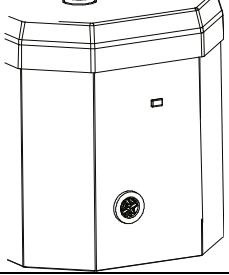
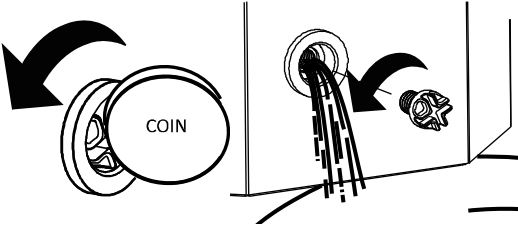
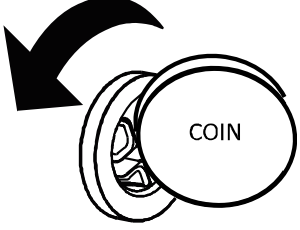
		
<p>1. Turn power off, take the plug out.</p>	<p>2. Turn on the tap until water runs cold, then fully turn off (approximately 3 litres).</p>	<p>3. Firmly pull up black rubber hose (a), press collar (c) down and pull pipe (b) out simultaneously. Prepare for small spillage.</p>
		
<p>4. Unhook boiler from brackets (if mounted to cabinet wall),</p>	<p>5. Open the drain on front of the unit. Drain fully into a suitable container or sink.</p>	<p>6. Once drained close the unit and place the boiler to one side.</p>

EITHER: Bypass the existing Proboil 2 black tundish assembly (This is the preferred option)

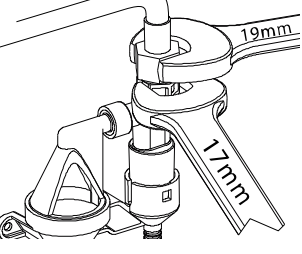
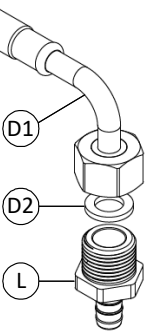
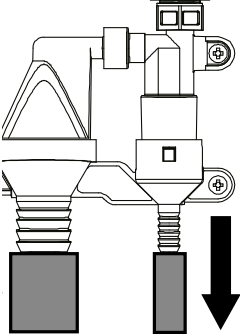
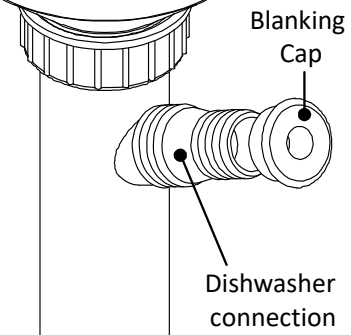
			
<p>1. Unscrew tundish (E3) from hose (D1) using spanners as shown.</p>	<p>2. Connect hose (D1) to 8mm barbed stem (L) ensuring washer (D2) is in place. Now connect outlet tube (K) to 8mm barbed stem (L).</p> <p>⚠ You must not connect hose (D1) directly to the male boiler outlet (C).</p>	<p>3. Pull black rubber boiled water outlet pipe (E2) from tundish (E3).</p>	<p>4. You can additionally remove the tundish assembly (E3 & E4) but the dishwasher connection MUST be blanked/capped off (see above).</p>

OR: Continue to use the PROBOIL2 tundish and drain hose (Not preferred option)

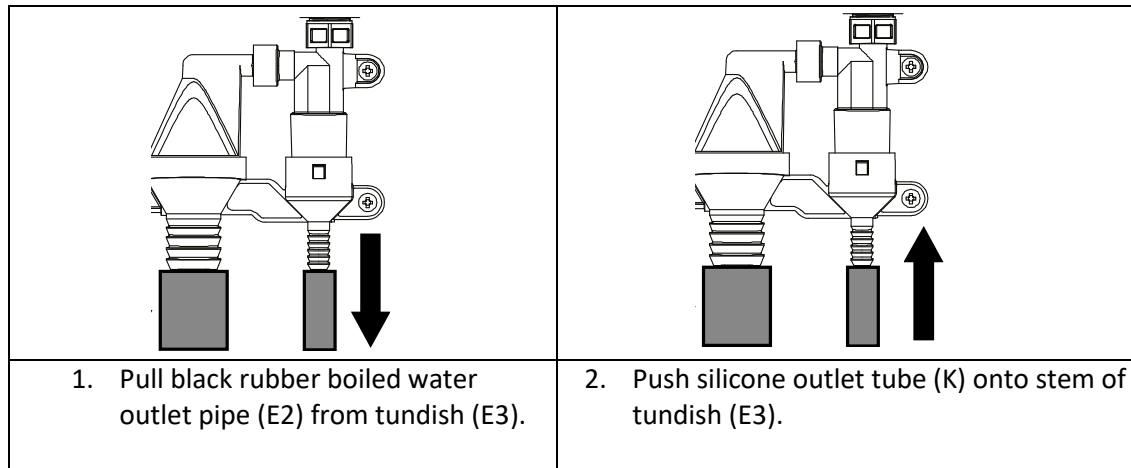

2.1.3 Install the new PROBOIL2X replacement boiler

This drawing can be used for reference throughout the PROBOIL2X replacement process:

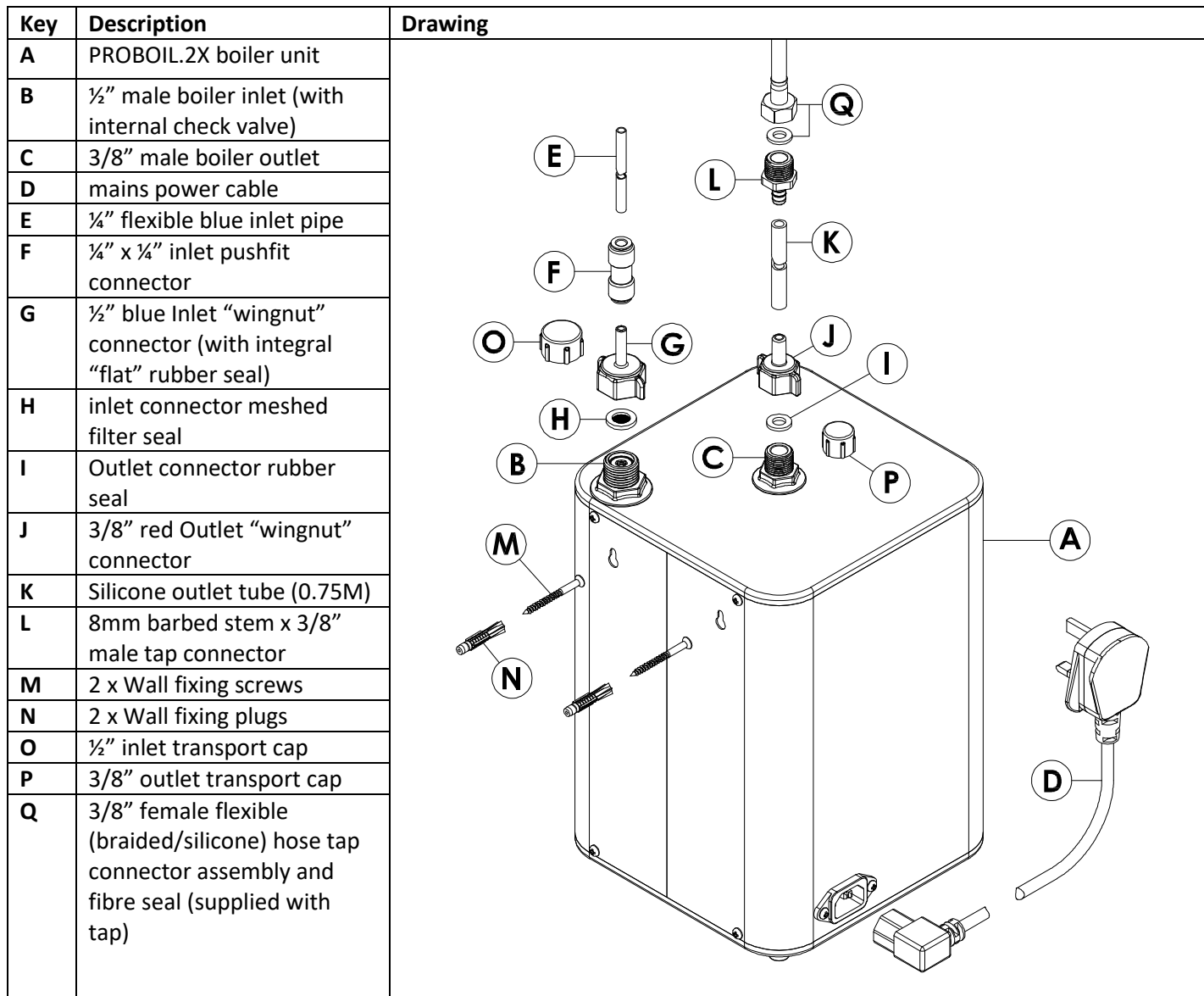

Installing new PROBOIL2X boiler:

⚠ WARNING: You must not solely use the overall assembly diagram as a guide to installation, we are not liable for any safety or performance issues as a result of not following the step by step installation guide in this guide with due care.

- 1) Insert the $\frac{1}{2}$ " rubber meshed seal (**H**) into the $\frac{1}{2}$ " boiler inlet (**B**), ensure the orientation of the seal is as shown.
- 2) Screw the $\frac{1}{2}$ " blue wingnut inlet connector with integral/ internal "flat" rubber seal (**G**) hand tight (**do not use a spanner or overtighten**) on to the boiler $\frac{1}{2}$ " inlet male (**B**).

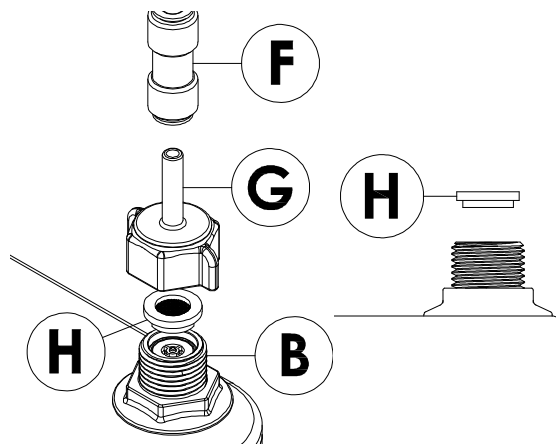

- 3) Check that the red $\frac{3}{8}$ " x 8mm boiler outlet connector (**J**) has pre-inserted internally the $\frac{3}{8}$ " rubber seal (**I**), **an additional seal is supplied, ensure to use only 1 x $\frac{3}{8}$ " rubber seal in this connection.**
- 4) Screw the red $\frac{3}{8}$ " x 8mm boiler outlet connector (**J**) hand tight (**do not use a spanner or overtighten**) on to the boiler $\frac{3}{8}$ " male outlet (**C**).

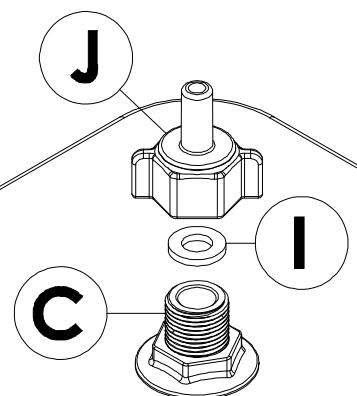

- 5) Plug the power cable (**D**) securely into the socket on the left-hand side of the boiler (**A**).

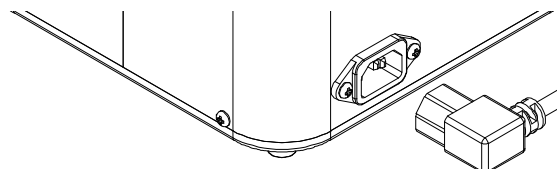

- 6) Hook the boiler keyhole slots onto its wall fixing screws (**M**) and check it is secure.

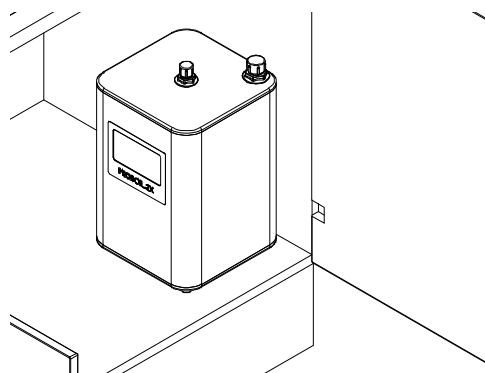

- 7) Check the end of blue pipe **(E)** for signs of wear, if needed cut the worn section of the end of the pipe using a sharp Stanley knife or similar.
- 8) Push the ¼" blue flexible pipe **(E)** fully and firmly into the ¼" x ¼" pushfit connector **(F)**

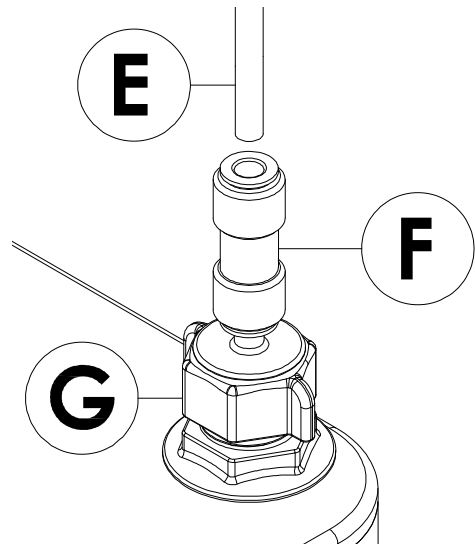

- 9) Firmly and fully push the silicone rubber outlet tube **(K)** over the red boiler outlet **(J)**.

The silicone outlet tube **(K)** must:

- a) **Not** be excessively long, creating a "dead leg".
- b) **Not** be too short (pipe is stretched).
- c) **Not** be twisted or kinked when attached (creating a blockage).

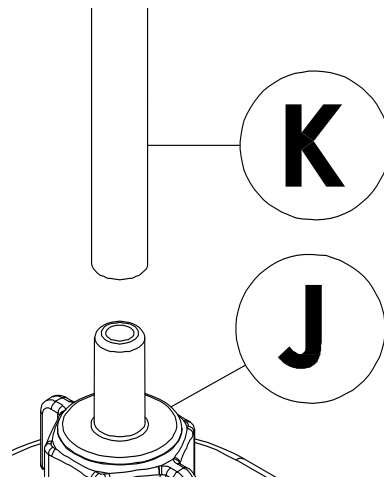

- 10) Your boiler is now plumbed to the tap and the filter, plug the power cord into the mains outlet **but do not switch on the mains power outlet at this time.**
- 11) Now turn on (open) fully the 98°C water handle. Water will now begin to purge air though the entire system.

i During the purging of air it is normal for the tap to spit, continue until the stream from the centre channel of the tap aerator is continuous. Depending on the incoming water pressure it will take apx. 2-3 minutes to fill the tank and purge the air.

- 12) Now turn off (close) fully the 98°C water handle.

2.1.4 Commissioning and testing

You have finished the installation, now please take a few moments to go through the commissioning and testing process, this will ensure the product is working correctly, safely and to your satisfaction.

 **WARNING:** You must not skip this section, we are not liable for any safety or performance issues as a result of not following the step by step installation guide with due care.

1. Turn on (open) fully the 98°C water handle.

 After the air is purged from the system you **must** continue to run cold water through the tank for a further minimum of a 5 minutes to flush it.



During the flushing period check all connections made during the installation carefully for leaks.

2. After the flushing period is completed turn off (close) fully the 98°C water handle.
3. Press and hold the “” key on the boiler screen, it should switch to the standard screen and not display any error “E” codes.
4. Press the “+” key on the boiler screen and set the target temperature to 98°C.
The boiler will take approximately **9 minutes** to reach its “**READY**” state. Use this time to complete the checklist items in this guide.



The few first times the boiler fills and heats from a “fully cold” state it is normal that the tap may drip slightly from the spout centre channel during heating, this will self-adjust with use.

5. After the boiler reaches its “**READY**” state repeat steps 1-2.
6. With all tap handles in the closed position again check the installation carefully again for any leaks.